

Magellan™ 9800i



Datalogic ADC, Inc.

959 Terry Street
Eugene, OR 97402
USA
Telephone: (541) 683-5700
Fax: (541) 345-7140

© 2012-2013 Datalogic ADC, Inc.

An Unpublished Work - All rights reserved. No part of the contents of this documentation or the procedures described therein may be reproduced or transmitted in any form or by any means without prior written permission of Datalogic ADC, Inc. or its subsidiaries or affiliates ("Datalogic" or "Datalogic ADC"). Owners of Datalogic products are hereby granted a non-exclusive, revocable license to reproduce and transmit this documentation for the purchaser's own internal business purposes. Purchaser shall not remove or alter any proprietary notices, including copyright notices, contained in this documentation and shall ensure that all notices appear on any reproductions of the documentation.

Should future revisions of this manual be published, you can acquire printed versions by contacting your Datalogic representative. Electronic versions may either be downloadable from the Datalogic website (www.datalogic.com) or provided on appropriate media. If you visit our website and would like to make comments or suggestions about this or other Datalogic publications, please let us know via the "Contact Datalogic" page.

Disclaimer

Datalogic has taken reasonable measures to provide information in this manual that is complete and accurate, however, Datalogic reserves the right to change any specification at any time without prior notice.

Datalogic and the Datalogic logo are registered trademarks of Datalogic S.p.A. in many countries, including the U.S.A. and the E.U. All other brand and product names may be trademarks of their respective owners.

Magellan is a registered trademark of Datalogic ADC, Inc. in many countries, including the U.S.A. and All-Weighs, FirstStrike and SurroundScan are registered trademarks of Datalogic ADC, Inc. in the U.S.A. OmegaTek, Produce Rail, Productivity Index Reporting and SmartSentry are all trademarks of Datalogic ADC, Inc.

This product may be covered by one or more of the following patents:

Utility Patents: DE60126118.6 ▪ DE60143659.8 ▪ DE60319809.0 ▪ DE60336771.2 ▪ DE60341050.2 ▪ DE69941090.8 ▪ EP1114391 ▪ EP1307854 ▪ EP1330772 ▪ EP1479054 ▪ EP1481378 ▪ EP1828957 ▪ EP1890272 ▪ EP2287817 ▪ GB2346474 ▪ US5420410 ▪ US5446271 ▪ US5463211 ▪ US5481098 ▪ US5493108 ▪ US55635699 ▪ US5686716 ▪ US5834708 ▪ US5837983 ▪ US5929421 ▪ US6012639 ▪ US6073849 ▪ US6237852 ▪ US6343741 ▪ US6478224 ▪ US6499662 ▪ US6561427 ▪ US6585157 ▪ US6705527 ▪ US6729603 ▪ US6783072 ▪ US6857567 ▪ US6877663 ▪ US6917723 ▪ US7108170 ▪ US7132947 ▪ US7170414 ▪ US7172123 ▪ US7201322 ▪ US7204422 ▪ US7215493 ▪ US7234641 ▪ US7374092 ▪ US7407096 ▪ US7495564 ▪ US7506816 ▪ US7527198 ▪ US7562817 ▪ US7619527 ▪ US8006904 ▪ US8011579 ▪ US8113428 ▪ US8172145 ▪ USRE40071 ▪ USRE43089 ▪ ZL200680003342.2

Additional patents pending.

Table of Contents

Chapter 1. Introduction	1
Manual Overview	2
How to Use This Manual.....	3
Scanner Nomenclature	4
Connectors and Ports.....	5
Physical Parameters	7
Scanning	7
EAS Tag Deactivation System.....	7
Weighing	8
Scale Sentry™ Option.....	8
Warm-Up Time.....	9
Electrical Specifications	10
Power Supply	10
Safety Precautions.....	11
Labeling.....	12
Agency Compliances	13
Bar Codes Supported.....	15
1D Symbolologies	15
2D Symbolologies	15
Technical Support.....	16
Datalogic Website Support	16
Reseller Technical Support.....	16
Telephone Technical Support.....	16
Chapter 2. Site Preparation and Installation	17
Installing the Optional TDR.....	18
Pre-Installation Considerations.....	20
Checkstand Design Recommendations	21
Scanner Installation.....	22
Scanner Maintenance.....	22
References	22
Scanner Usage	22
Site Preparation Overview	23
Ventilation and Spacing	26
Service Access	26
Power Installation	27
Grounding	27

Checkstand Preparation	27
Liquid Spills and Moisture	27
Counter Cutout	28
Checkstand Mounting.....	34
Installation Overview	34
Unpacking	35
Operational Verification	36
Diagnostic Modes	38
Cables & Connections.....	40
Remote Scale Display Placement/Installation	42
Lighting Considerations	42
Viewing Angle	42
Remote Display Cabling	43
Placing and Installing the Remote Display	43
Changing Weighing Modes	45
Set-Up & Installation	45
Set-up.....	45
System Power-Up Recap	49
Chapter 3. Operation and Maintenance	51
Scanning Items	51
Proper Weighing Technique (Scale Models).....	52
Deactivating Security Labels.....	53
Operational Controls	54
Operational Modes.....	54
Power-Up/Selftest & Pre-Operation	54
Operating Mode	55
Additional Functions	56
Programming	56
Diagnostic Mode	56
Scanner and Scale Reset.....	56
Scale Adjustments	57
Operational Maintenance	58
Vertical Scan Window Replacement	58
Horizontal Scan Window Replacement (DLC)	60
Chapter 4. TDR, Camera and Mobile Commerce	61
Optional TDR Feature	61
Camera Feature.....	62
Mobile Commerce Reader	62
Chapter 5. Problem Isolation	63
Diagnostic Procedures	64
Error Codes	64
Scale Error Reporting	67
Flowcharts	68
Chapter 6. Calibration Procedures	75
Description of Calibration Sequence	76

Motion Test	76
Automatic Zero Setting Test.....	77
Preparing the Scanner/Scale for Calibration.....	77
Calibrating the Scale (Pounds & Kilograms).....	78
Calibration Verification (Pounds)	80
Calibration Verification (Kilograms)	85
Chapter 7. Programming	91
Introduction to Label Programming.....	91
Understanding the Basics	91
Using a Bar Code Mask.....	91
Going Green	91
Bar Code Mask	92
Integrating the Scanner With Your Host System.....	93
Customizing Your Scanner's Operation.....	93
Programming Overview	94
Programming via Handheld Device.....	94
What Is Programming Mode?.....	94
Entering and Exiting Programming Mode.	94
Programming Session	95
Programming Sequence	96
LED and Beeper Indicators	98
If You Make a Mistake.....	98
Test Mode	99
Chapter 8. Imaging Features	101
Top Down Reader (TDR) and Mobile Commerce Imaging Features	101
Mobile Commerce Reader Enable	102
Mobile Commerce Imagers.....	103
Mobile Commerce Button Function	104
TDR Enable	105
Image Camera	106
Image Format.....	107
Image Size	108
Image Brightness	109
Image Contrast	111
Chapter 9. General Scanner and Scale Features	113
1D Double Read Timeout.....	113
2D Double Read Timeout.....	114
Label Gone Timeout	115
Sleep Mode Timer.....	116
1D Inverse Read Control.....	117
2D Inverse Read Control.....	118
Illumination Control.....	118
2D Contrast Improvement.....	119
Good Read LED Idle State	120
Scanner Control Button Options.....	121
Power-up Tone Control	122

Good Read Beep Control.....	123
Good Read Beep Frequency.....	124
Good Read Beep Length.....	125
Good Read Beep Volume	126
Good Read When to Indicate.....	127
Scale Zero Button and Scale Indicator LED.....	128
Scale Sentry	129
Scale Sentry Block Weight Transmission	130
Scale Sentry Override Button	131
Scale Enable	132
Scale Diagnostics Mode.....	133
Scale Stale Weight Timeout	134
Scale Enforced Zero Return.....	135
Scale Interface Type	136
Scale Calibration Notification	138
Scale Intercharacter Delay	139
Remote Display — Enable/Disable.....	140
Auxiliary Port Mode.....	141
Auxiliary USB Mode	142
Productivity Index Reporting (PIR) / Cashier Training (CT)	143
PIR/CT Auxiliary Port Baud Rate.....	144
Chapter 10. EAS Features	147
EAS Features — Sensormatic.....	147
EAS Mode.....	148
EAS Notification.....	150
EAS Security Level.....	151
EAS Good Beep Mode	152
EAS Beep Duration	153
EAS Retry Count.....	154
EAS Exception Button.....	155
EAS Deactivation Duration — Coupled	156
EAS Deactivation Duration — Retry.....	157
EAS Deactivation Duration — Exception	158
EAS Pre-Read Time	159
EAS Features — Checkpoint	160
ERI Active State	160
ERI Timeout	161
Chapter 11. Interface Related Features	163
Interface Type.....	163
RS-232 Interface Selection	165
USB Interface Selection.....	166
IBM Interface Selection	167
Keyboard Interface Selection.....	168
Maximum Host-Transmitted Message Length	169
IBM Features	170
IBM Interface Options.....	170
IBM Scale Address.....	171

IBM Transmit Labels in Code 39 Format.....	172
46XX Number of Host Resets.....	173
46XX Label Slicing Control.....	174
46XX Maximum Label Slice Length.....	175
USB OEM Interface Options.....	176
USB OEM Scanner Device Type.....	177
RS-232 Features.....	178
RS-232 Baud Rate.....	178
RS-232 Number of Data Bits.....	180
RS-232 Number of Stop Bits.....	181
RS-232 Parity.....	182
RS-232 Hardware Control.....	183
RS-232 Intercharacter Delay.....	184
RS-232 Software Flow Control.....	185
RS-232 Ignore Host Commands.....	186
RS-232 TTL.....	187
RS-232 TTL Invert.....	188
RS-232 Beep on ASCII BEL.....	189
RS-232 Beep After Weigh.....	190
Beep on Not on File.....	191
RS-232 ACK NAK Enable.....	192
RS-232 ACK Character.....	193
RS-232 NAK Character.....	194
RS-232 Retry on ACK NAK Timeout.....	195
RS-232 ACK NAK Timeout Value.....	196
RS-232 ACK NAK Retry Count.....	197
RS-232 ACK NAK Error Handling.....	198
RS-232 Indicate Transmission Failure.....	199
Single Cable RS-232 Options.....	200
Single Cable RS-232 Scanner Only Protocol.....	201
Single Cable RS-232 RTS CTS Selection.....	202
Single Cable RS-232 Use BCC.....	204
Single Cable RS-232 Use ACK/NAK.....	205
Single Cable RS-232 Use STX.....	206
Set Single Cable RS-232 STX Character.....	207
Single Cable RS-232 Use ETX.....	208
Set Single Cable RS-232 ETX Character.....	209
Single Cable RS-232 Datalogic Extensions.....	210
Single Cable RS-232 Pacesetter Plus.....	211
USB Keyboard and Keyboard Wedge Features.....	212
USB Keyboard and Keyboard Wedge Intercharacter Delay.....	212
Keyboard Wedge No Keyboard Support.....	213
USB Keyboard and Keyboard Wedge Send Control Characters.....	214
USB Keyboard and Keyboard Wedge Country Mode.....	215
Keyboard Wedge Quiet Interval.....	219
USB Keyboard and Keyboard Wedge Caps Lock State.....	220

Chapter 12. Data Editing.....	221
Data Editing Overview.....	221

Please Keep In Mind.....	222
Case Conversion	222
Character Conversion	223
Global Prefix.....	224
Global Suffix	225
Global AIM ID Enable	226
Label ID Control	227
Label ID	228
1D Symbologies	228
2D Symbologies	233
Global Mid-Label ID.....	234
Chapter 13. 1D Symbology Programming	235
1D Symbologies.....	235
Coupon Control.....	236
UPC-A Enable.....	237
UPC-A Number System Character Transmission	238
UPC-A Check Character Transmission	239
UPC-A Minimum Read.....	240
Expand UPC-A to EAN-13.....	241
UPC-E Enable	242
UPC-E Number System Character Transmission.....	243
UPC-E Check Character Transmission.....	244
Expand UPC-E to UPC-A.....	245
Expand UPC-E to EAN-13.....	246
UPC-E Minimum Read	247
EAN-13 Enable.....	248
EAN-13 First Character Transmission	249
EAN-13 Check Character Transmission	250
EAN-13 ISBN Conversion Enable	251
EAN-13 Minimum Read.....	252
EAN-8 Enable	253
EAN-8 Check Character Transmission.....	254
Expand EAN-8 to EAN-13	255
EAN-8 Minimum Read	256
EAN-8 Guard Insertion	257
EAN-8 Guard Substitution.....	258
EAN-8 Stitch Exact Label Halves	259
EAN-8 Stitch Unlike Label Halves	260
Other UPC/EAN Options	261
In-Store Printed Label Minimum Read	262
UPC/EAN Reconstruction	263
UPC/EAN Correlation	264
UPC/EAN Guard Insertion	265
UPC/EAN Stitch Exact Label Halves	266
UPC/EAN Stitch Unlike Label Halves	267
UPC/EAN Minimum Segment Length	268
Price Weight Check	270
Enable EAN Two Label	272

EAN Two Label Minimum Read	273
Addons	274
GTIN Enable.....	281
GS1 DataBar	282
DataBar Omnidirectional Enable.....	282
DataBar Omnidirectional/EAN-128 Emulation.....	283
DataBar Omnidirectional 2D Component Enable.....	284
DataBar Omnidirectional Minimum Read.....	285
DataBar Expanded Enable	286
DataBar Expanded EAN-128 Emulation.....	287
DataBar Expanded 2D Component Enable	288
DataBar Expanded Minimum Read	289
DataBar Expanded Length Control	290
DataBar Expanded Length 1	291
DataBar Expanded Length 2.....	292
Code 39 Enable.....	293
Code 39 Start Stop Character Transmission.....	294
Code 39 Check Character Calculation	295
Code 39 Check Character Transmission	296
Code 39 Full ASCII.....	297
Code 39 Minimum Read.....	298
Code 39 Correlation.....	299
Code 39 Length Control.....	300
Code 39 Length 1.....	301
Code 39 Length 2.....	302
Code 39 Stitching	303
Code 39 Require Margins.....	304
Code 32 Italian Pharmacode Enable	305
Code 32 Start Stop Character Transmission.....	306
Code 32 Check Character Transmission	307
Code 128 Enable	308
Code 128 Transmit Function Characters.....	309
Expand Code128 to Code 39.....	310
Code 128 Minimum Read	311
Code 128 Correlation	312
Code 128 Length Control	313
Code 128 Length 1	314
Code 128 Length 2	315
Code 128 Stitching.....	316
EAN-128 Enable	317
Interleaved 2 of 5 (I 2 OF 5) Enable.....	318
I 2 of 5 Check Character Calculation	319
I 2 of 5 Check Character Transmission.....	320
I 2 of 5 Minimum Read	321
I 2 of 5 Correlation	322
I 2 of 5 Length Control	323
I 2 of 5 Length 1	324
I 2 of 5 Length 2.....	325
I 2 of 5 Stitching.....	326

Codabar Enable.....	327
Codabar Start Stop Character Transmission	328
Codabar Start Stop Character Set	329
Codabar Start Stop Character Match	330
Codabar Check Character Calculation.....	331
Codabar Check Character Transmission	332
Codabar Minimum Read	333
Codabar Correlation	334
Codabar Length Control.....	335
Codabar Length 1	336
Codabar Length 2	337
Codabar Stitching	338
Codabar Require Margins	339
Code 93 Enable	340
Code 93 Minimum Read	341
Code 93 Correlation	342
Code 93 Length Control	343
Code 93 Length 1	344
Code 93 Length 2.....	345
Code 93 Stitching.....	346
MSI Enable	347
MSI Check Character Calculation	348
MSI Number of Check Characters	349
MSI Check Character Transmission.....	350
MSI Minimum Read	351
MSI Correlation	352
MSI Length Control	353
MSI Length 1	354
MSI Length 2.....	355
MSI Stitching.....	356
Standard 2 of 5 Enable	357
Standard 2 of 5 Check Character Calculation	358
Standard 2 of 5 Check Character Transmission.....	359
Standard 2 of 5 Minimum Read	360
Standard 2 of 5 Correlation	361
Standard 2 of 5 Length Control	362
Standard 2 of 5 Length 1	363
Standard 2 of 5 Length 2.....	364
Standard 2 of 5 Stitching.....	365
Chapter 14. 2D Symbology Programming	367
2D Symbologies.....	367
Data Matrix Enable	368
Data Matrix Length Control	369
Data Matrix Length 1, Length 2 Programming Instructions	370
PDF 417 Enable	371
PDF 417 Length Control	372
PDF 417 Length 1, Length 2 Programming Instructions	373
PDF 417 Read Option.....	374

Micro PDF 417 Enable	375
Micro PDF 417 Length Control	376
Micro PDF 417 Length 1, Length 2 Programming Instructions	377
Micro PDF 417 128 Emulation	378
QR Code Enable	379
QR Code Length Control	380
QR Code Length 1, Length 2 Programming Instructions	381
Micro QR Code Enable	382
Micro QR Code Length Control	383
Micro QR Code Length 1, Length 2 Programming Instructions	384
Aztec Enable	385
Aztec Length Control	386
Aztec Length 1, Length 2 Programming Instructions	387
Appendix A. LED/Audio Indications & Controls	389
Good Read Indicators	389
Controls and Indicators	390
LED and Audio Indications	391
ScaleSentry / Scale Service Button	394
Sensormatic EAS Button	395
Camera Button	395
Mobile Commerce Button	395
Scanner Control Button	396
Scale Zero Button	397
Calibration Switch	398
Appendix B. Cable Information	399
Introduction	399
General Specifications	399
External Cable Pinouts	400
Appendix C. Keypad	403
Appendix D. microSD Card	405
microSDHC Compatibility	405
microSD Card Insertion	405
microSD Card Removal	406
Autorun File Processing	407
microSD Function Summary	407
microSD Function Details	408
From Scanner to microSD Card	408
From microSD Card to Scanner	410
Appendix E. Host Commands	411
Accepting Commands from an RS-232 Scanner Host	411
Appendix F. Factory Defaults	413

Appendix G. Handheld Data Format Requirements	427
Handheld Data Format Requirements General	427
Datalogic Handheld Data Format Requirements.....	428
AIM Formats.....	433

Chapter 1

Introduction

This manual provides details for installation, configuration, calibration and operation of the scanner or scanning-scale.



NOTE

For the purposes of this manual, any Magellan 98xx model may be termed as simply “scanner” (including scanning-scale models).

Because of differences due to multiple model types and options, the illustrations shown in this manual may vary from the model(s) in use at your location.

Manual Overview

[Chapter 1, Introduction](#), presents the manual's contents, describes features and specifications, provides regulatory and safety information, and lists the bar code symbologies the scanner will read.

[Chapter 2, Site Preparation and Installation](#), supplies physical dimensions for the scanner or scanning-scale and its most common accessories, and details counter preparation and installation. Cable routing, connection and testing are also explained in this section.

[Chapter 3, Operation and Maintenance](#), describes use and maintenance; providing details about operator controls, programming and diagnostic modes, scale "zeroing" and calibration. Scanner and scale routine maintenance are outlined in this section as well.

[Chapter 4, TDR, Camera and Mobile Commerce](#), defines the functions of the optional Top Down Reader, Camera and Mobile Commerce Reader features.

[Chapter 5, Problem Isolation](#), provides an outline of three scanning-scale test modes: Selftest, Operational Tests and Diagnostic Tests. Descriptions of the error indications if the scanner detects a system problem and troubleshooting flowcharts to aid in problem resolution are also presented.

[Chapter 6, Calibration Procedures](#), explains scale calibration and verification procedures, including procedures for calibrating the scale in pounds as well as kilograms.

[Chapter 7, Programming](#), and subsequent chapters detail procedures and provide custom bar codes for setting programmable scanner and scanning-scale features.

[Appendix A, LED/Audio Indications & Controls](#), lists the various functions and indications of the scanner's control panel features.

[Appendix B, Cable Information](#), outlines wire requirements, connector specifications and pinout details for associated product cabling.

[Appendix C, Keypad](#), furnishes bar codes representing the digits and characters required to enter extended programming data needed during certain programming sessions.

[Appendix D, microSD Card](#), describes the use and functions of the microSD Card Slot.

[Appendix E, Host Commands](#), contains a partial listing of available host commands that can be used with a compatible host interface.

[Appendix F, Factory Defaults](#), provides a listing of factory default settings based on the most common interface.

[Appendix G, Handheld Data Format Requirements](#), specifies additional references for use when a handheld scanner is connected to the scanner.

How to Use This Manual

You'll find it helpful to familiarize yourself with the first section of this manual, since it provides both a general description of the product's features and an overview of the manual's contents and organization. Reference the other sections as required for information about scanner or scanning-scale installation, operation, maintenance, calibration and bar code programming.

Manual Conventions



'NOTE' blocks contain information that is helpful and recommended. They provide information that is critical to operations and/or procedures described in this manual.



'LEGAL NOTE' blocks indicate procedures or activities which may be regulated under law by governmental agencies. It is your responsibility to ensure compliance with the regulations that govern installation of weighing devices.



'CAUTION' blocks inform you that proper handling (adherence to the procedures described) is required to avoid damage to equipment and/or property.



'WARNING' blocks alert you to potential physical harm or injury. These statements do not include potentially fatal hazards, which would be designated as **'DANGER'** blocks. Use of this product does not warrant the need for a **DANGER** block.

Scanner Nomenclature

The parts and features of the scanner are shown in [Figure 1](#). Control Panel buttons and indicators are described in more detail in [Appendix A](#).



NOTE

Optional features include the Scale (for weighing items) Top Down Reader (TDR) and Electronic Article Surveillance (EAS). Your scanner may or may not support all of these capabilities.

Figure 1. Scanner Nomenclature

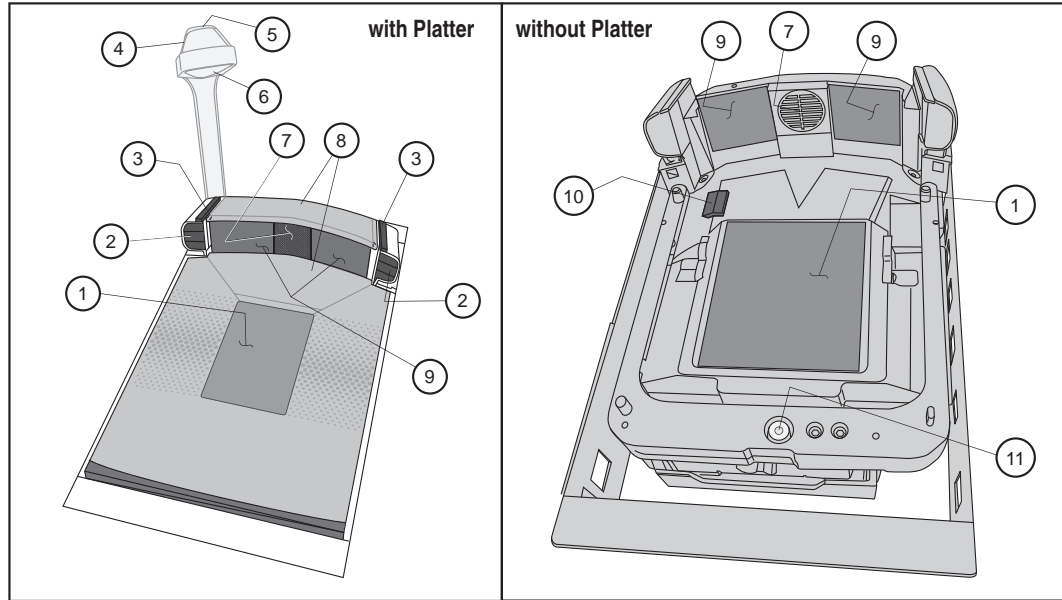

1	Horizontal Scan Window	6	Top Down Reader (TDR) (optional)
2	Control Panels	7	Speaker
3	Good Read Indicator LED	8	All Weighs™ Platter
4	Mobile Commerce Reader (optional)	9	Vertical Scan Windows
5	Mobile Commerce/Camera Indicator LED	10	Service Port Cover (microSD and USB test)
		11	Bubble Level

Connectors and Ports

Connector port availability and appearance will differ between models, since these optional features may sometimes be added at the time of purchase. See the illustrations in [Figure 1](#), [Figure 2](#) and [Figure 3](#).

- Checkpoint® Electronic Article Surveillance (EAS) Feature
- Sensormatic® Electronic Article Surveillance (EAS) Feature
- Scale (weighing) Feature
- Remote Display Accessory (for models with a scale)
- Top Down Reader (TDR) / Camera / Mobile Commerce Features
- microSD Card Reader (item #10 in [Figure 1](#))
- USB Service Port (item #10 in [Figure 1](#))

Figure 2. Optional EAS Cable Connections

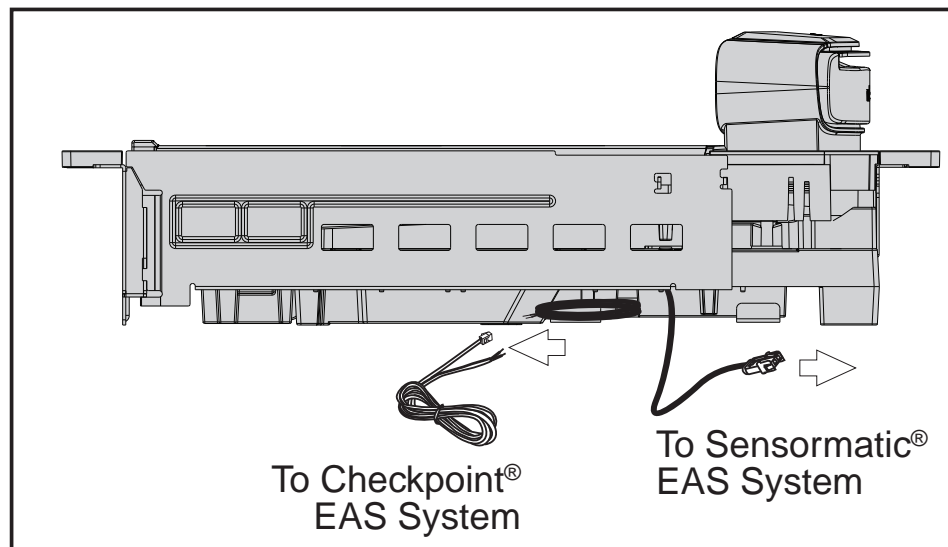
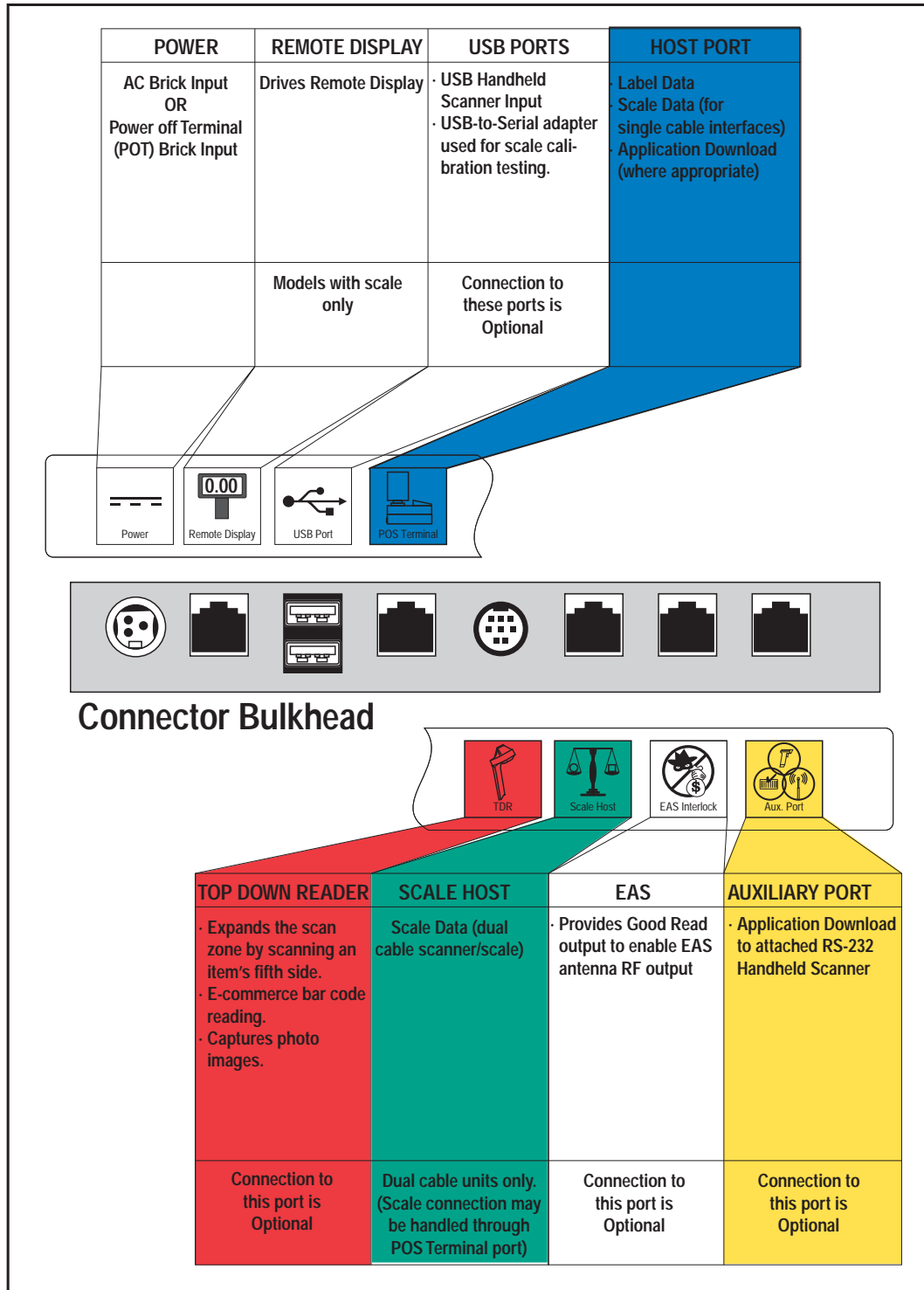

Figure 3. Connector Panel



Physical Parameters

This section provides specifications for performance, environmental and electrical parameters. Reference the second section of this manual, [Site Preparation and Installation](#), for physical measurements of all models and some accessories.

Scanning

A scan zone ([Figure 4](#)) exists in the area between the horizontal and vertical scan windows, and the Top Down Reader (TDR), if that optional feature is present. Separate projections from each of these sources combine to form a zone where bar code labels are read. Refer to the [Operation and Maintenance](#) section of this manual for more details about the topic: [Scanning Items](#).

Figure 4. Scan Zone

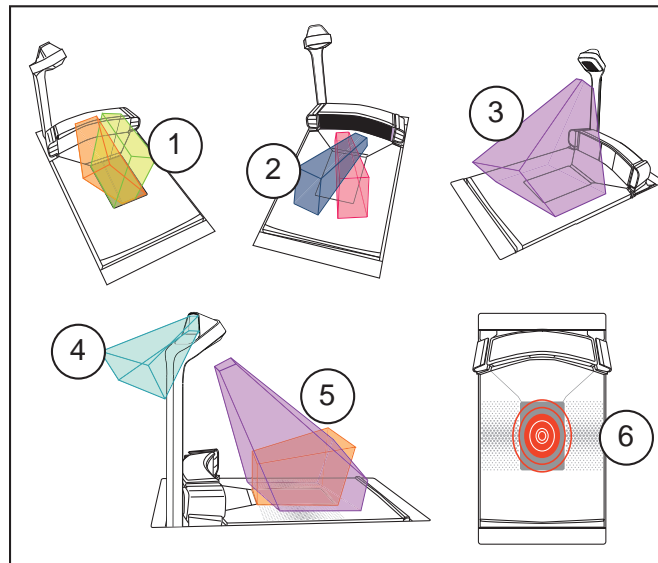

1	Horizontal Scan Zone	4	Optional Mobile Commerce Scan Zone
2	Vertical Scan Zone	5	Combined Scan Zone
3	Optional TDR Scan Zone	6	Move items through the center of the horizontal window for best scan coverage

EAS Tag Deactivation System

Scanners can be ordered from the factory to include an optional EAS (Electronic Article Surveillance) deactivation system. Two different EAS system types are available: Checkpoint¹ and Sensormatic².

The Sensormatic[®] deactivation system requires connection as shown in [Figure 2a](#). Reference [Chapter 3, "Deactivating Security Labels"](#) for more information about its use.

Contact [Technical Support](#) for information about installation of the Sensormatic AMB-9010 or ScanMaxPro EAS controller box. Additional details about this system can be referenced under the following topics:

- [Chapter 3, "Deactivating Security Labels"](#)
- [Chapter 7, "EAS Features — Sensormatic"](#)

1. Checkpoint is a registered trademark of Checkpoint Systems, Inc
2. Sensormatic is a registered trademark of Sensormatic Electronics Corporation.

Weighing

Specifications for scale capacity, settling time, minimum and maximum static weight, zeroing, and warm-up time are given below. For more information regarding the topic: [Proper Weighing Technique](#), refer to the [Operation and Maintenance](#) section of this manual.

Rated Weight Capacity

The scale's operational weight capacity is:

- 30.00 pounds, displayed in 0.01 increments
OR
- 15.000 kilograms¹, displayed in 0.005 increments.

Minimum Weight

The minimum weight that can be accurately measured by the scale is 0.02 lb. (0.005 kg).

Maximum Static Weight (Overload)

A maximum static weight of 150 pounds (68 kg) can be sustained by the scale without incurring damage or degrading performance.

Automatic Zero Maintenance

The scale's software constantly monitors and adjusts the Zero point as long as the deviation is within acceptable limits², while compensating for any debris accumulation or removal. During power-up, the scale automatically re-zeros after verifying that all subsystems are functional. Additionally, the scale may be manually "zeroed" by pushing the Scale Zero Button located on the control panel.

Scale Sentry™ Option

The optional ScaleSentry feature monitors items placed on the platter to ensure they are not overhanging and touching non-weighing surfaces. If the system's infrared (IR) beams sense items encroaching past the sides of the weigh platter, the speaker will sound a unique tone and/or the ScaleSentry LED indicator will illuminate to indicate a ScaleSentry error condition. ScaleSentry optionally blocks the transmission of weight to the host depending on how it is configured (see "Scale Sentry" starting on page 129). The scanner/scale can be programmed to just beep and/or light the LED if there is a ScaleSentry issue. Reference [Using the Optional ScaleSentry™ Feature on page 53](#) for more ScaleSentry options and details.

1. The scale can also be set at the factory for 9.99 kg max.

2. Acceptable limits of deviation are set at -0.2 to +0.6 pounds (-0.078kg to 0.23kg), which is -0.67 to +2.0% of total capacity.

Warm-Up Time

There are two pertinent warm-up times that apply to the scanning-scale:



The two warm-up periods can be performed concurrently, thereby reducing the total required warm-up time to 60 minutes.

NOTE

Thermal Equilibrium

When the unit is moved from a cooler temperature (such as a storage area) to a warmer environment (such as a checkstand location), 60 minutes must be allowed to acclimate the unit to ambient conditions prior to calibration or operation.

Power-up

Once installed and powered up, a warm-up time of 15 minutes must be allowed before calibrating or performing weighing operations.

Figure 5. Environmental Specifications

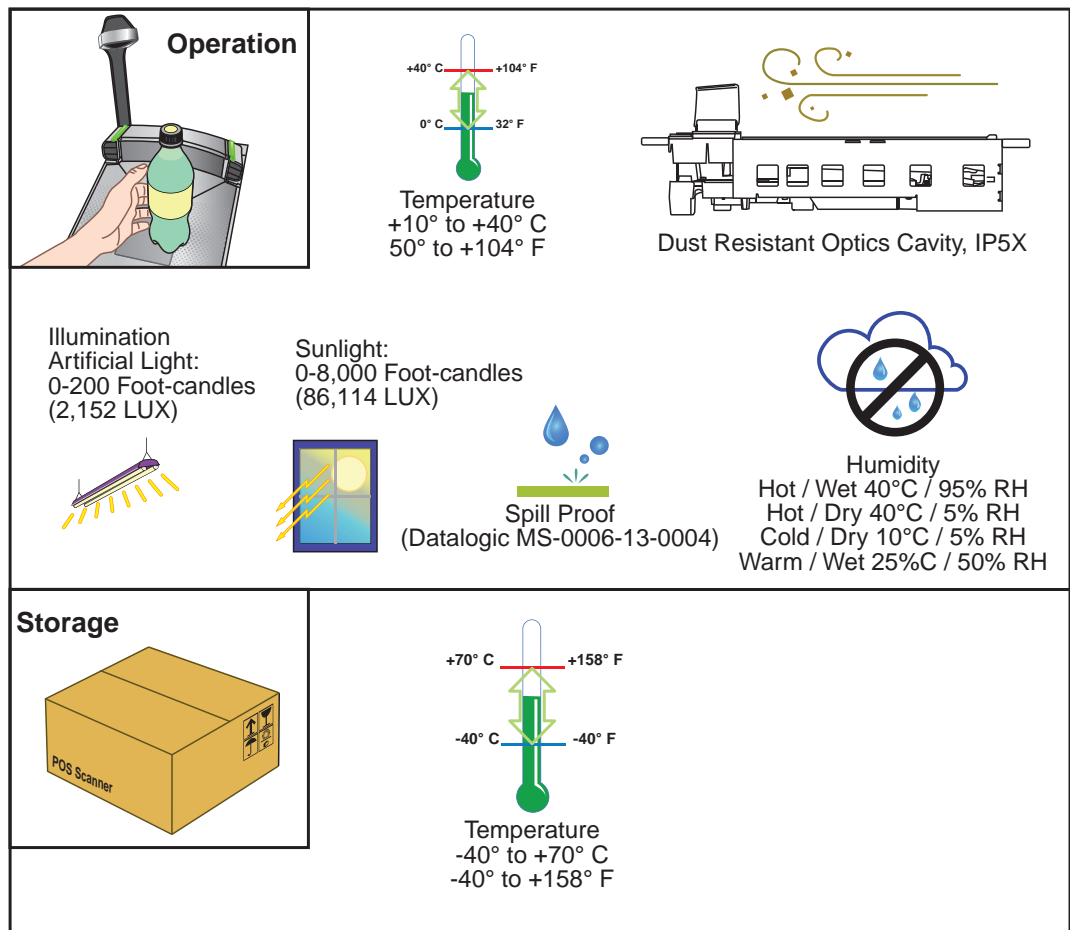

Electrical Specifications

Before installation, always verify that the site's electrical service meets the scanner's requirements. The scanner has been engineered for compatibility with most international electrical systems operating in ranges from 100 to 240VAC at 50-60 Hz. Verify that the power source will supply "clean" electrical power to the equipment; that is, it must be free of excess electrical noise.

Check the IEC power cord shipped with the scanning-scale. If the cord will not plug into your AC power receptacle, the power cord shipped is not compatible with your electrical system. Please contact your distributor immediately to receive the necessary information and components to ensure electrical compatibility.

Power Supply

The scanner utilizes a single power supply for all models. Unique installation and international connections are accomplished through selection of the proper IEC power cord

VOLTAGE	FREQUENCY	CURRENT (RMS)
100-240VAC \pm 10%	50-60 Hz	0.5 Amps @ 100V



Safe operation of your scanner or scanning-scale requires properly grounded electrical outlets. Be sure to have a qualified electrician certify the earth-ground connection on circuits which will be used to power the unit.

CAUTION



The scanner is powered on/off by connecting/disconnecting its power supply.

NOTE

Safety Precautions



CAUTION

No adjustments or alteration of the scanner or scanning-scale housing are to be attempted by the user.



WARNING

This equipment has been tested and found to comply with the limits for a Class A digital device, pursuant to part 15 of the FCC Rules. These limits are designed to provide reasonable protection against harmful interference when the equipment is operated in a commercial environment. This equipment generates, uses, and can radiate radio frequency energy and, if not installed and used in accordance with the instruction manual, may cause harmful interference to radio communications. Operation of this equipment in a residential area is likely to cause harmful interference in which case the user will be required to correct the interference at his or her own expense.

This Class A digital apparatus meets all requirements of the Canadian Interference-Causing Equipment Regulations.

Cet appareil numérique de la classe A respecte toute les exigences du Règlement sur le matériel brouilleur du Canada.

Labeling

Regulatory, reference and safety labeling is shown in Figure 6.

Figure 6. Labeling

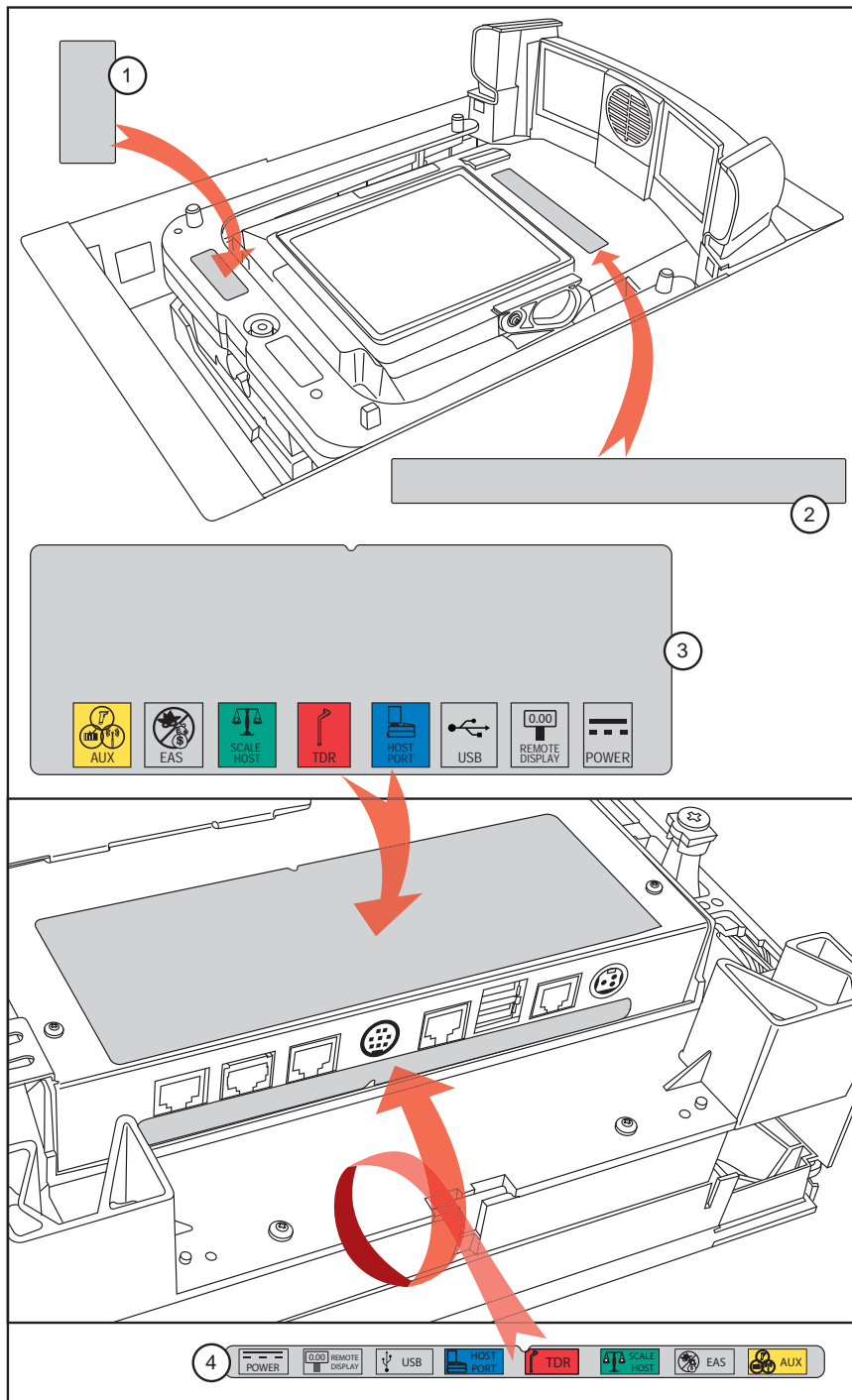

Beneath the Platter		Underside of Scanner	
1	Scale Regulatory Label (units with scales only)	3	Regulatory - I/F Label
2	Serial Number Label	4	Connector Bulkhead Label

Agency Compliances

The scanner and scanning-scale meets or exceeds the requirements for its device type as set forth by the following agencies and regulations:

COUNTRY	COMPLIANCE	COMMENTS
Safety		
United States	UL60950-1	cULus Approved
Canada	CAN/CSA C22.2 No. 60950-1	cULus Approved
World	IEC60950	CB certification
Korea	KCC-Mark	
EMC/EMI		
United States	FCC part 15 subpart J	Class A
Australia/N Zealand	AS/NZS CISPR 22	Class A
Canada	ICES-003	Class A
Europe	EN 55022	Class A
Japan	VCCI 2011-4	Class A
ROW	CISPR 22	Class A
Korea	KN-22	KCC mark
Optical Emissions		
Europe and ROW	EN/IEC 62471	LED illumination
Weights & Measures (Scale units only)		
United States	NIST Handbook 44 (Dept. of Commerce)	NCWM-NTEP
Canada	Measurement Canada	
Europe	2009/23/EEC	EN45501
Australia	National Measurement Institute (NMI)	NMI R76, Parts 1 and 2
New Zealand	1999 Part 1	Regulations 5 and 6
Mexico	NOM-010-SCFI-1994	
Bureau International de Métrologie Légale (BIML)	OIML R76-1 and R76-2 certification	Class III scale, non-automatic weighing

COUNTRY	COMPLIANCE	COMMENTS
Power Supply		
USA/Canada	Safety	cULusa
State of California	CEC-400-2010-012	Energy Efficiency Standard
Canada	NR Canada	Energy Efficiency Standard
Europe	CE and Level IV efficiency	Safety, EMC and energy efficiency Erp2009/125 EEC
ROW	CB cert	CB Safety Scheme
Mexico	NOM and CONUEE	Safety and Energy Efficiency
Japan	PSE	Safety J60950-1 and J55022
Russia	GOST	
Australia	RCM and MEPS	Safety AS/NZS 60950-1 and AS.NZS4665 (energy efficiency)
Korea	KCC and MEPS	Safety, EMC and Energy Efficiency
Taiwan	BSMI	Safety CNS 14336-1 and EMC CNS 13438
China	CCC	Safety and EMC
Argentina	IRAM S mark	Safety
South Africa	SABS	Safety

Contact Datalogic ADC, Inc. or your Datalogic representative for a complete listing of approvals for other countries.

Bar Codes Supported

The scanner can read/decode the following 1D and 2D bar code types (symbolologies):

1D Symbolologies

- UPC Versions A & E
- Plural Stage Dual UPC Bar Codes for Japan (2 label read)
- GSI DataBar Omnidirectional, DataBar Expanded, DataBar Stacked
- EAN-8 & 13
- JAN-8 & 13
- UCC/EAN 128
- GTIN Support
- Code 39
- Code 39 full ASCII
- Code 128 (including conversion to Code 39)
- Code 93
- Interleaved 2 of 5 (I 2 of 5)
- Industrial 2 of 5 (sometimes referred to as Standard 2 of 5)
- Code 32 (Italian Pharmaceutical Code)
- Codabar
- MSI

2D Symbolologies

- PDF417, including driver's license parsing
- MicroPDF
- Data Matrix
- Aztec
- QR Code
- Micro QR

Technical Support

Datalogic Website Support

The Datalogic website (www.datalogic.com) is the complete source for technical support and information for Datalogic products. The site offers product support, warranty information, product manuals, product tech notes, software updates, demos, and instructions for returning products for repair.

Reseller Technical Support

An excellent source for technical assistance and information is an authorized Datalogic reseller. A reseller is acquainted with specific types of businesses, application software, and computer systems and can provide individualized assistance.

Telephone Technical Support

If you do not have internet or email access, you may contact Datalogic technical support at (541) 349-8283 or check the back cover of your manual for more contact information.

Chapter 2

Site Preparation and Installation

This section provides instructions on preparation of the checkstand for scanner or scanning-scale installation. It also specifies physical parameters, power and ventilation considerations, cable routing information and unit installation.

The guidelines that follow, titled [Checkstand Preparation](#), present specifics for models available at the time of this writing.

Some models are designed to fit with little or no modification into openings cut for previously installed scanners such as other Magellan™ scanners, or NCR® scanner models 7874/5/6/7/8. Other models are designed for applications with smaller footprint requirements. See [Figure 8](#) for models available at the time of this printing.

Additionally, a Top Down Reader (TDR) module ([Figure 7](#)) can be optionally included with a scanner for installation. A TDR is purchased in one of two heights (tall or short) to allow flexibility of installation.

Once the procedures in this section are complete, the scanner is ready for operation, excepting that if a scanning-scale was installed, calibration will be required before placing the unit into operation. You must consult the local weights and measures authority to ensure that all legal requirements are met concerning calibration and certification. [Chapter 6. Calibration Procedures](#), contains detailed procedures for calibrating the scale in either pounds or kilograms.

Figure 7. Top Down Reader (TDR) Details

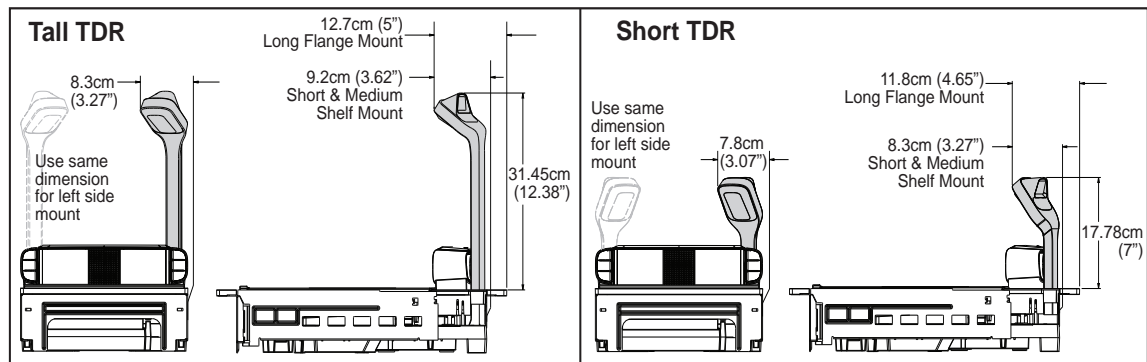
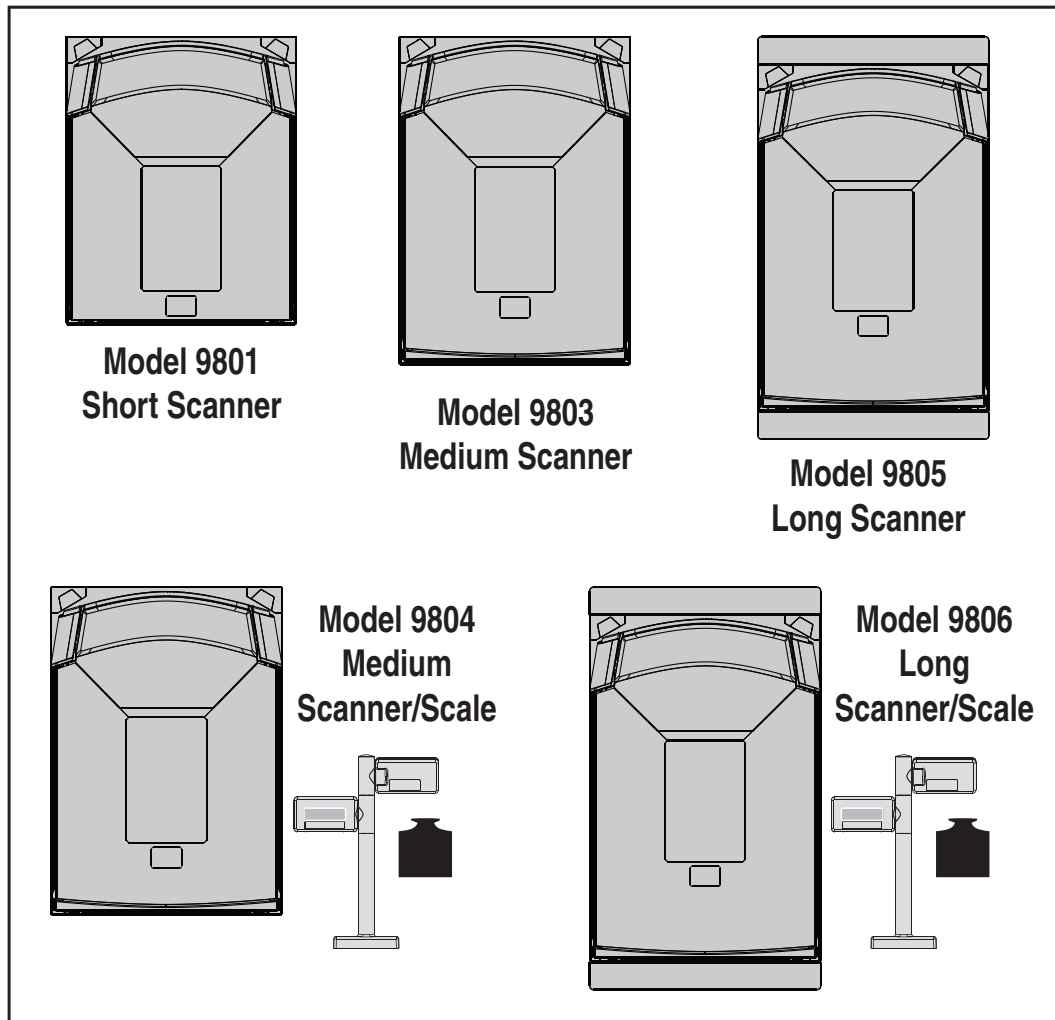

Figure 8. Scanner and Scanner/Scale Models



Installing the Optional TDR

Depending upon the model (see [Figure 8](#)), steps to install will vary slightly.

1. [Long Scanner/Scale models ONLY] After disconnecting power, remove the two bolts that secure the Back Flange Assembly ([Figure 9](#), #1) to the Scanner/Scale, then slide the assembly down and away from the unit. Set the assembly and its bolts aside for later reinstallation.
2. Determine the corner of the scanner where you desire the TDR to be installed. It must reside in the left hand or right hand corner just behind the scanner's bonnet. Carefully push upwards on that plastic Corner Piece to disengage it from the scanner ([Figure 9](#), #2).
3. Gently slide the Filler Tab flatwise from the Corner Piece ([Figure 9](#), #3). This will leave an opening which mates with the neck of the TDR.
4. Orient the TDR as shown ([Figure 9](#), #4).
5. Mate the Corner Piece with the TDR ([Figure 9](#), #5).

6. Route the TDR cable down through the base of the scanner (Figure 9, #6), gently pulling it all the way through on the bulkhead side of the base and seating the TDR in its corner cavity. Make sure it is not pinched or caught beneath the scanner base.
7. Use a 3mm ball end hex driver to secure the TDR with the two bolts provided for this purpose (Figure 9, #7), tightening them evenly to 1.74Nm (15 in-lb).
8. Fully seat the plastic Corner Piece in the grooves intended for it on the scanner frame (Figure 9, #8).
9. Verify that the cable is not pinched or caught between assemblies, then connect it to its 8-pin Din connection in the center of the bulkhead (Figure 9, #9).
10. [Long Scanner/Scale models ONLY] Secure the Back Flange Assembly (Figure 9, #1) to the Scanner/Scale using the original bolts. Tighten both evenly to 0.79 Nm (7 in-lb).

Figure 9. Installing the Optional TDR

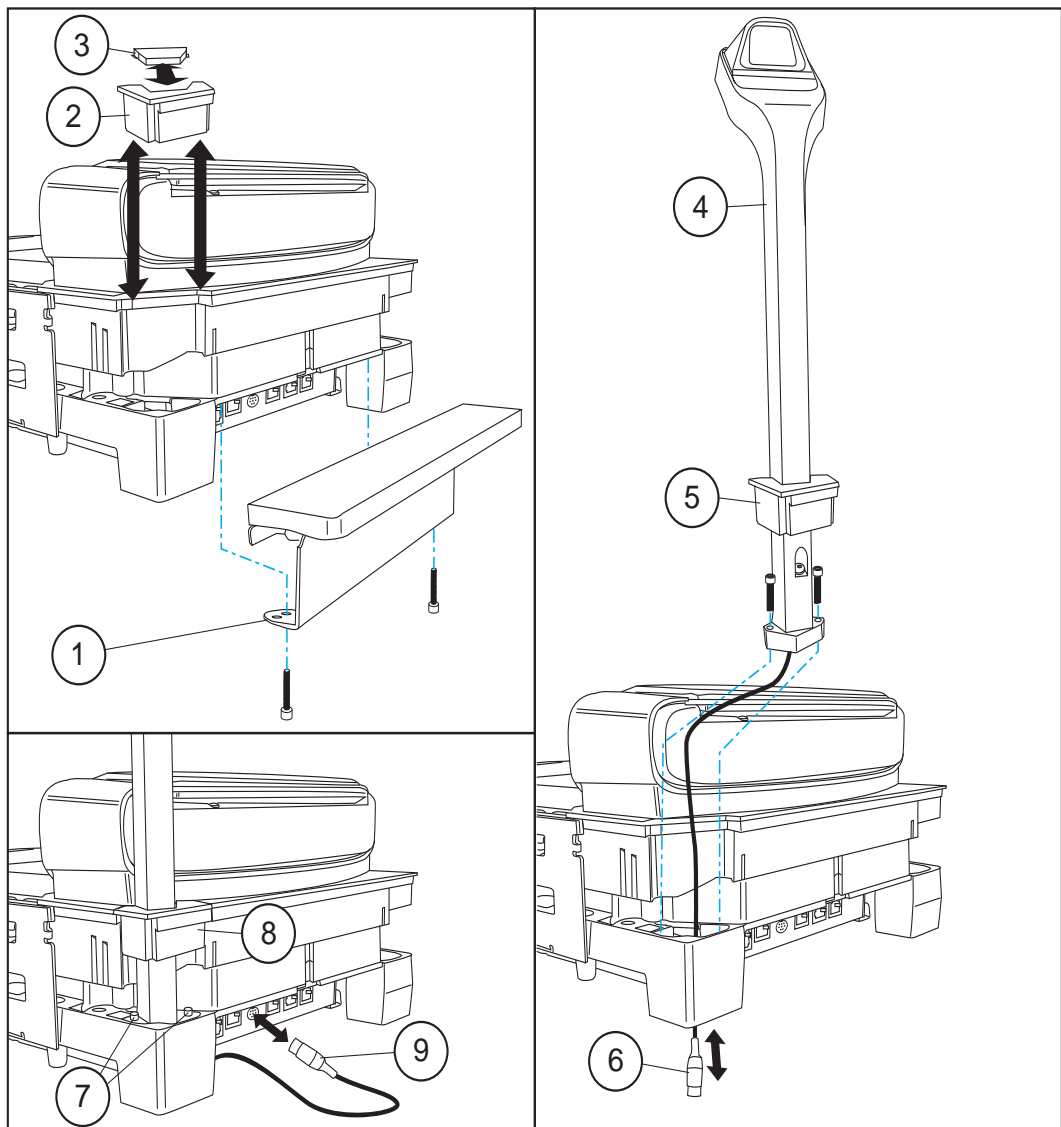

Pre-Installation Considerations

This manual does not cover all factors relating to worker safety and checkstand design. It does, however, offer a list of considerations that may be helpful in ensuring greater safety and productivity. Careful planning using these general guidelines should result in a more efficient, comfortable work environment.

The U.S. Bureau of Labor Statistics reports that the incidence of repetitive motion injuries has increased dramatically in recent years. Checkstand design and scanner installation and operation procedures can reduce the risk of repetitive motion injuries, but not eliminate it.

Although there are currently no formal guidelines for checkstand ergonomics, the Food Marketing Institute (FMI), Occupational Safety and Health Administration (OSHA) and the National Institute of Occupational Safety (NIOSH) of the Department of Health and Human Services have released the reports listed at the end of these recommendations. These reports contain useful suggestions for ergonomic improvement of checkstand designs and scanner installation, maintenance and usage. Portions of the reports are summarized below. For copies of the complete reports, or to inquire about any modifications to the recommendations, contact FMI, OSHA and NIOSH at the addresses listed at the end of these recommendations.

Checkstand Design Recommendations

1. Select a design which allows load-sharing by several muscle groups (for example designs which allow the cashier to use both hands for scanning and bagging).
2. Use a powered in-feed conveyor to help cashiers bring the items to their best work zone, rather than leaning and reaching to get items further up the conveyor.
3. Select checkstands which deliver products to the cashier on an input belt and do not require the unloading of items from a cart. These designs put less stress on the cashiers' shoulders and back.
4. Minimize the distance between the input and take-away conveyors (i.e., the distance the cashier has to reach to move the products).
5. Minimize the width of the input conveyor to reduce the cashier's reach to items on the far side of the belt; use a diverter or "sweeper" to direct products closer to the cashier.
6. Select a design which encourages the cashier to slide products across the scanner rather than gripping and lifting. Make sure the horizontal surface of the scanner is flush with all surrounding surfaces.
7. Choose a design which integrates the scanner and scale to eliminate extended reaches and lifts during weighing tasks.
8. Place the conveyor belt electronic eye close to the scanner, but allow sufficient area between the eye to ensure the belt does not push items in to the scanning field.
9. Locate commonly used items such as the cash drawer and printer within easy horizontal reach.
10. Remove, round-off, or pad sharp or hard edges with which the cashier may come into contact.
11. Provide an easily accessible bag stand at a height 13 - 17 inches (33 - 43.2 cm) lower than the top surface of the checkstand to reduce stresses to the shoulders, elbows, and risks associated with lifting products into bags.
12. Do not position the bag stand between the cashier and the scanner, due to the increased reach involved.
13. Position the scanner's horizontal scanning surface 34 - 36 inches (86.4 - 91.4 cm) above the floor. Maintain a minimum of five inches (12.7 cm) clearance between elbows and work surfaces.
14. Provide adjustable keyboard mounting (height, tilt, and horizontal reach).
15. Position the printer, cash drawer, and other checkstand devices the cashier uses within easy reach (less than 18 inches/45.7 cm).
16. Provide adequate toe space (at least four inches), foot rests or rails, antifatigue mats, and where feasible, an adjustable seat or stand against which the cashiers can lean.

Scanner Installation

1. Mount the horizontal surface of the scanner flush with the countertop to encourage slide scanning rather than lifting.
2. Position the centerline of the scanner read area 8 - 10 inches (20.3 - 25.4 cm) from the edge of the checkstand (cashier side).

Scanner Maintenance

1. Keep scanner windows clean. This will improve productivity and reduce rescans.
2. Replace scanner glass when excessive scratches are evident.

References

U.S. Department of Labor
Guidelines for Retail Grocery Stores
www.osha.gov

Anonymous, 1992, "Ergonomic Improvement of Scanning Checkstand Designs",
Food Marketing Institute
800 Connecticut Ave. N.W.
Washington, D.C. 20006

Grant, Katharyn A. et al., 1992, "Ergonomic Evaluation of Checkstand Designs in the Retail Food Industry",
National Institute of Occupational Safety and Health
4676 Columbia Parkway
Cincinnati, Ohio 45226

Scanner Usage

1. Minimize handling of heavy/bulky products. Leave these items in the cart and use an alternative entry method such as key entry of short PLUs, LaneHawk® BOB (Bottom Of Basket) technology, or handheld scanning.
2. Regularly train cashiers in proper scanning methods and ergonomics principles, such as:
 - Develop a smooth fluid motion during scanning, sharing work equally between hands.
 - Use the entire hand for grasping and lifting items.
 - Since the scanner reads labels on multiple sides, there should be no need to particularly orient a bar code toward the scanner windows.
 - Develop efficient scanning motions, not necessarily faster hand movements. Simply slide the item across the scanner's horizontal window with as little orientation motion as necessary.
 - Leave items in an upright position; do not lift and tilt.
 - Learn how the scanner functions and where the scanning area is located.
 - Do not favor either the vertical or horizontal window; slide items across the scanner in their natural orientations on the checkstand as much as possible.

Site Preparation Overview

Consider the following factors before installing the scanner/scanning-scale and its optional Remote Scale Display.

Ventilation Requirements — The scanner operates without the use of a ventilation fan. As long as there is adequate convective air flow and no major heat producing equipment in close proximity, the unit's housing provides adequate heat dissipation. The air temperature in the checkstand around the scanner must not exceed 104°F (40°C).

Service Access Requirements — Routine operations such as 'zeroing' and calibration do not require removal of the scanner from the checkstand or disassembly of the product. The installer should plan service access for the AC/DC Power Supply and cables.

Recommended Power Installation — Since the typical grocery environment includes conveyor belts and electric motors, care should be taken to ensure that the scanner has a supply of "clean" power (power without excessive electrical noise).

Counter Preparation — Since the majority of grocery checkout lanes are designed as "left-hand take away," the counter drawings in this section focus on this counter design. Simply reverse the layout for a "right-hand take away" requirement. The unit scans equally well in either of these two configurations.

Liquid Drainage — Should a liquid spill occur, ensure that moisture can flow through the checkstand without pooling.

Leveling — Plan ahead and provide screws/bolts in the checkstand mounts and a leveling guide (board) to allow leveling of the scanner or scanning-scale within the counter. Use a 0.375" thick board to replicate the mounting flange on the long scanner or scanning-scale, and adjust screws or bolts until the board is flush within the counter. Use a 4.0" wide board stood on its end to adjust leveling screws/bolts in rail support applications.

Cable Routing — Placement of the scanning-scale should be planned to allow easy access to other components as well as optimize communication between the scanner, the POS terminal and the optional Remote Scale Display. Note that cables may drop straight down from the scanner's connector panel, or may be conveniently routed along the unit's side using the hardware provided. Do not route interface cables near any electrical motors or other sources of electromagnetic interference.

Remote Scale Display Placement — The customer, and checker in some instances, must be able to easily view and read the Remote Scale Display (if one is present). Ambient light and mounting height considerations are discussed later in this section.

Vertical Clearance — Provision must be made to allow adequate space above the scanner bonnet for removal and replacement of the All Weights™ Platter (the L-shaped platter). Optimal clearance permits the platter to be grasped at its top vertical edge and lifted for removal without obstruction (such as a fixed keyboard mount or any type of enclosure). Should such an enclosure be unavoidable, an alternate method of platter removal using two coins may be employed, however a minimum vertical clearance of 1.5" (3.8 cm) MUST be provided (reference [Figure 10](#)). Another consideration is that the scan zone must be kept free of obstructions such as enclosures, keyboard mounts, etc.

Figure 10. Vertical Clearance

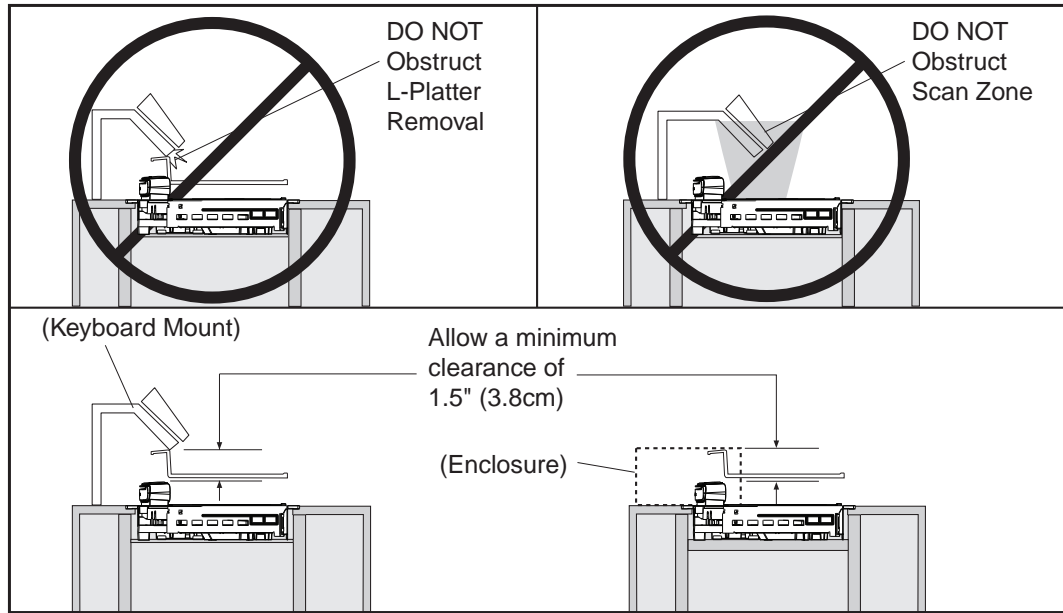

Display Clearance — Clearance must be allowed so that a POS display will not interfere with the scanner's read zones. Adjustment must be made depending upon whether or not there is a Top Down Reader (TDR) installed.

NO TDR — POS display placement for scanners not having a TDR must not encroach the scan zone formed by the horizontal and vertical windows. The bottom of the display must be no lower than the 30° line shown in [Figure 11](#), which projects from the front edge of the bonnet, 6 cm above the weigh platter.

With TDR — If a POS display is to be installed above the scanner in conjunction with an installed TDR (long or short model), the face of the display can be no closer than 2 cm behind the line shown in [Figure 12](#), which represents the frontmost edges of the scanner's bonnet.

Figure 11. Display Clearance With No TDR

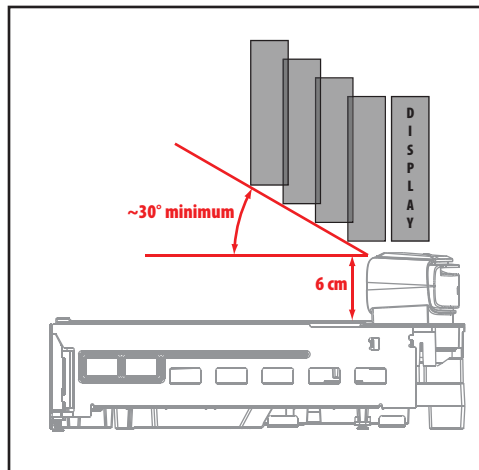
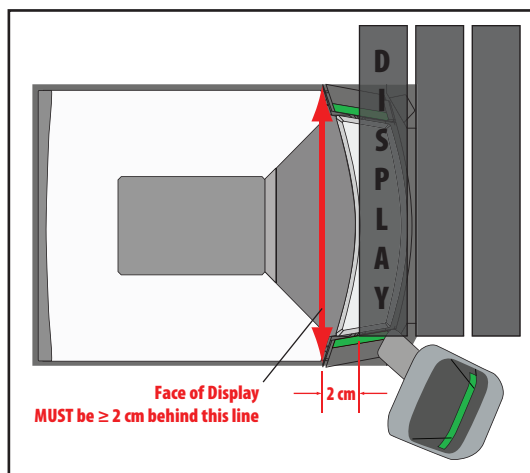

Figure 12. Display Clearance With TDR



Ventilation and Spacing

The scanning-scale's perimeter housing has been designed to provide adequate space for convective cooling and unrestricted movement of the weighing apparatus. Figure 13 shows the debris chutes and ventilation slots. The checkstand design must...

- keep the ambient air temperature inside the checkstand adjacent to the scanner below 104°F (40°C).
- allow a source of air that provides adequate cooling by convective air flow.



DO NOT place the scanner in a close-fitting, fully enclosed checkstand. Provide a MINIMUM of 16 square inches (103.2 square centimeters) of air intake from below the installation for sufficient convective cooling.

NOTE

If motors, conveyor belts, or other heat producing equipment are located near the scanner, forced air ventilation may be required. In most installations, a 30 cfm (.84 cmm) axial fan should provide sufficient air movement. If a ventilation fan is installed, it is recommended to use one with a removable filter that may be washed or replaced.

Figure 13. Debris Chutes & Ventilation Slots

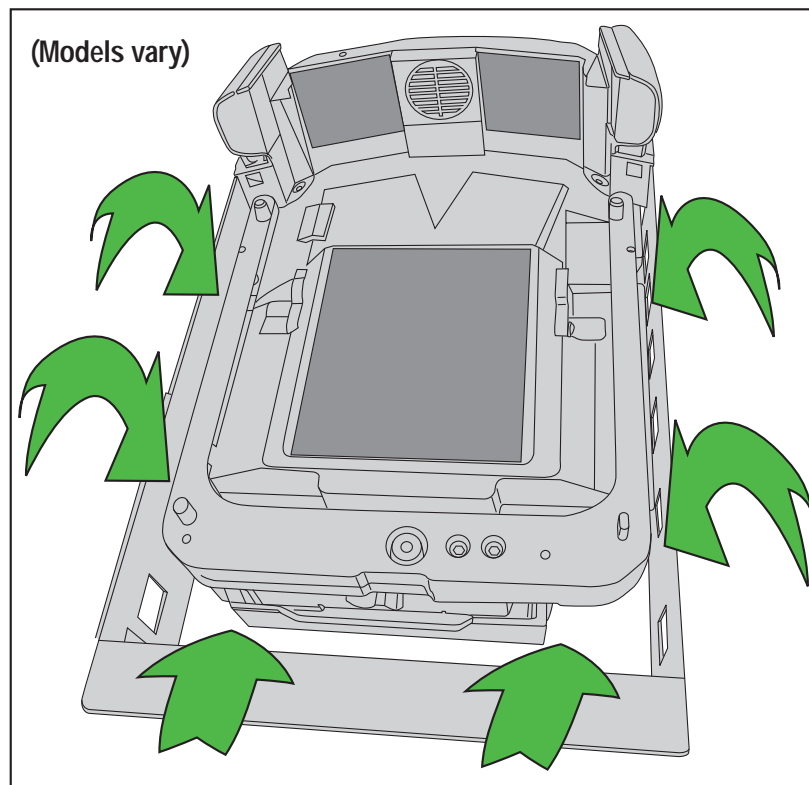

Service Access

The scanner and scanning-scale have been engineered to allow performance of all routine service and maintenance (such as “zeroing” and calibration) without removing the scanner from the checkstand. Additionally all cable connections made at the scanner can be connected and removed while the unit is sitting on the countertop. The installer should provide service access to all remaining cable connectors as well as the AC/DC Power Supply (if installed).

Power Installation

Plug your scanner into an electrical outlet that has been wired to meet all applicable electrical codes, laws, and regulations and has a common ground with the Point-of-Sale terminal.

Grounding

The AC/DC Power Supply should have an AC outlet with a clean earth ground. If you are not sure how to verify the amount of electrical noise (interference) on the power line, ask a qualified electrician to measure the input line voltage.

Checkstand Preparation

Reference [Figure 14](#). When performing a first time installation into a new checkstand, verify before cutting that room will be allowed for cabling and the AC/DC Power Supply. When making the opening, take extra care to accurately cut to the correct dimensions. Mounting may require installation of support(s), countertop routing, or other such devices. Depending upon checkstand design, you may wish to install an item diverter to direct items toward the scan window. See the instructions in this manual titled “Counter Cutout” for more details concerning the location and preparation of the opening.

Figure 14. Installation Overview

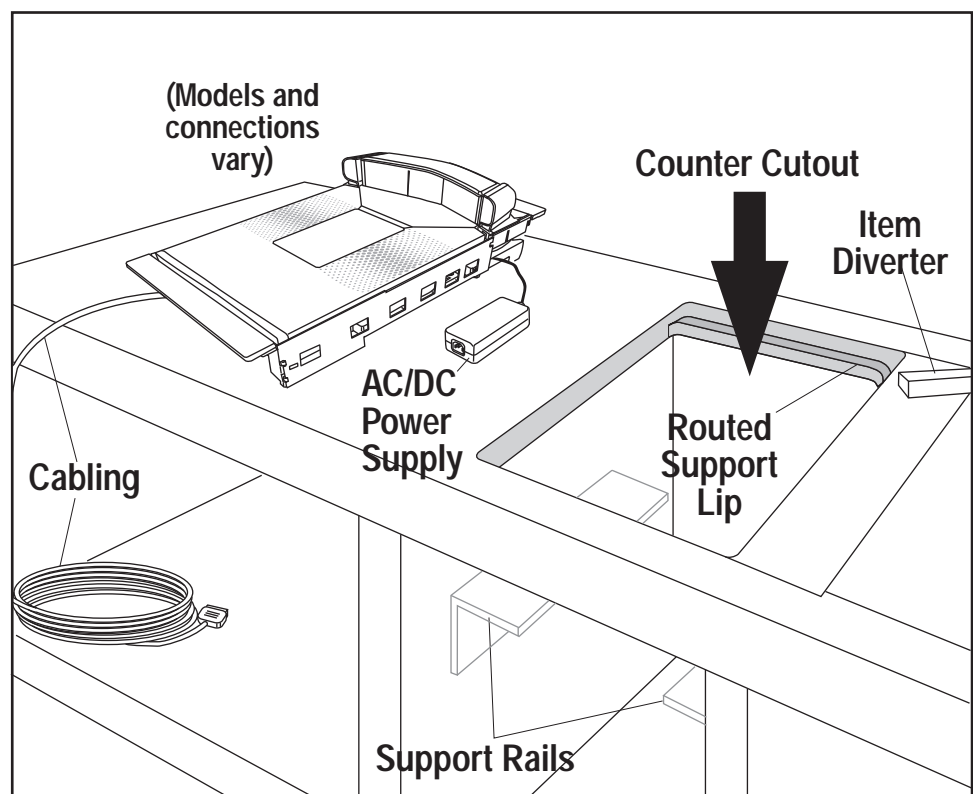

Liquid Spills and Moisture

Select a checkstand design which allows fluids to flow through, and directs liquids away from any electronic equipment or storage areas.

Counter Cutout

The most important consideration when planning the counter opening for the scanner is the operator's comfortable reaching distance. The ideal, ergonomically sound installation allows items to be directed within easy reach, and a scanning area requiring no lifting or special orientation of items. If you haven't already read the information at the beginning of this section titled, [Pre-Installation Considerations](#), please do so before continuing these instructions.

The symmetrical design of the scanner permits the operator to easily pass items from one hand to the other while scanning (either from right-to-left or left-to-right). With the unique multi-side scan zone, scanning is accomplished in one fluid motion. The operator simply slides the item from the conveyor belt or diverter area through the scanning area and passes the item to the other hand, which in turn bags it or places it on a take-away conveyor belt. Movement should flow naturally over the surface of the scanner.

Note that the following guidelines for preparing an existing checkstand to accept a scanner, or incorporating the unit into a new checkstand design will not be accurate for all installations. Although these guidelines will suffice for most standard installations, the installer may need to make adjustments for varying counter heights and thicknesses, support design, or other checkstand limitations.

[Figure 15](#) shows a typical “left-hand-take-away” checkstand design.

Follow these basic steps to install the unit:

1. Select a position for the scanner that offers a smooth product flow which best accommodates the reaching distance of the average operator.
2. Cut the opening in the countertop. Select the appropriate drawing from [Figure 17](#), or [Figure 20](#) for your model.
3. Install the AC/DC Power Supply, the Remote Scale Display cable and the interface cable(s) observing the following:
 - Interface cables (and display cable, if applicable) should be routed away from all highly inductive electrical devices, like motors and conveyor belts, and even away from the unit's power cable if possible.
 - Cables should be easy to remove in the event that replacement is required. A little planning now will save a lot of frustration later.
4. Connect and verify all system operations.

The scanner should be installed so that leading and trailing edges of the All Weighs™ Platter are flush with the countertop to enhance smooth, slide-through scanning (reference [Figure 16](#)). Keep in mind that the debris chutes on both sides of the platter provide the necessary clearance for proper scale operation if you are installing a scanning-scale (you won't need to provide an additional gap for that).

Figure 15. Typical Checkstand Design & Cutout Location

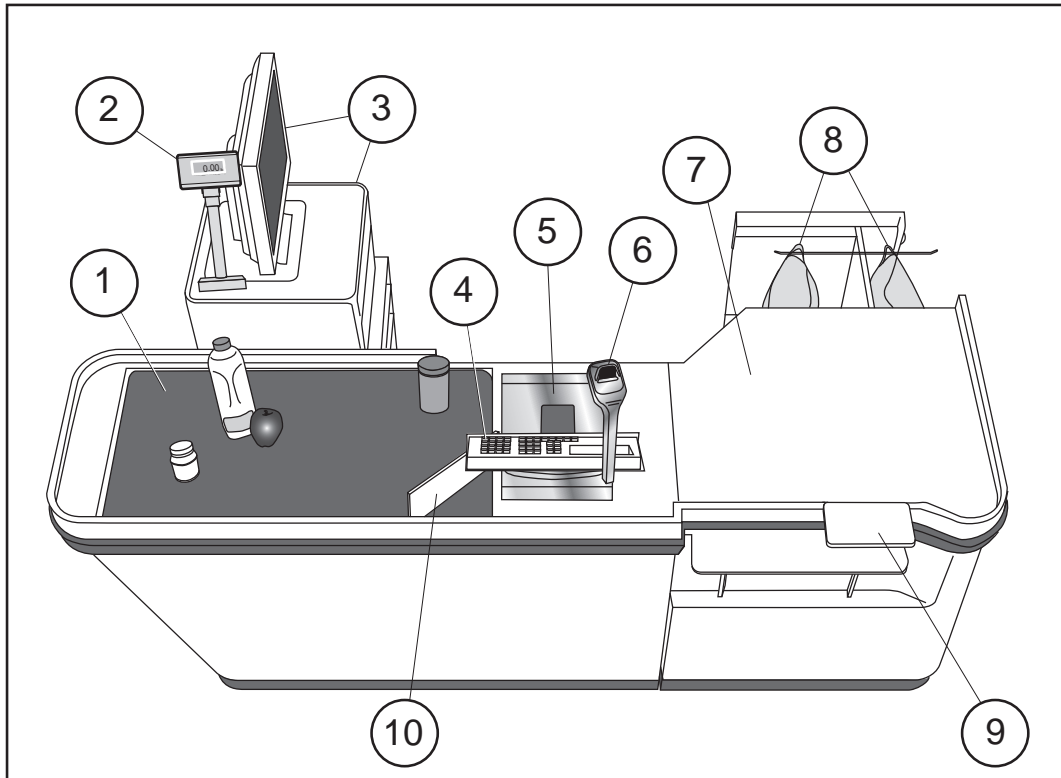

1	Conveyor	6	Top Down Reader (TDR) (optional)
2	Remote Display	7	Bagging Area
3	POS Terminal and Printer	8	Bag Well
4	Keyboard	9	Check Writing Stand (optional)
5	Scanner or Scanning-Scale	10	Item Diverter (optional)

Figure 16. Mounting the Scanner Flush

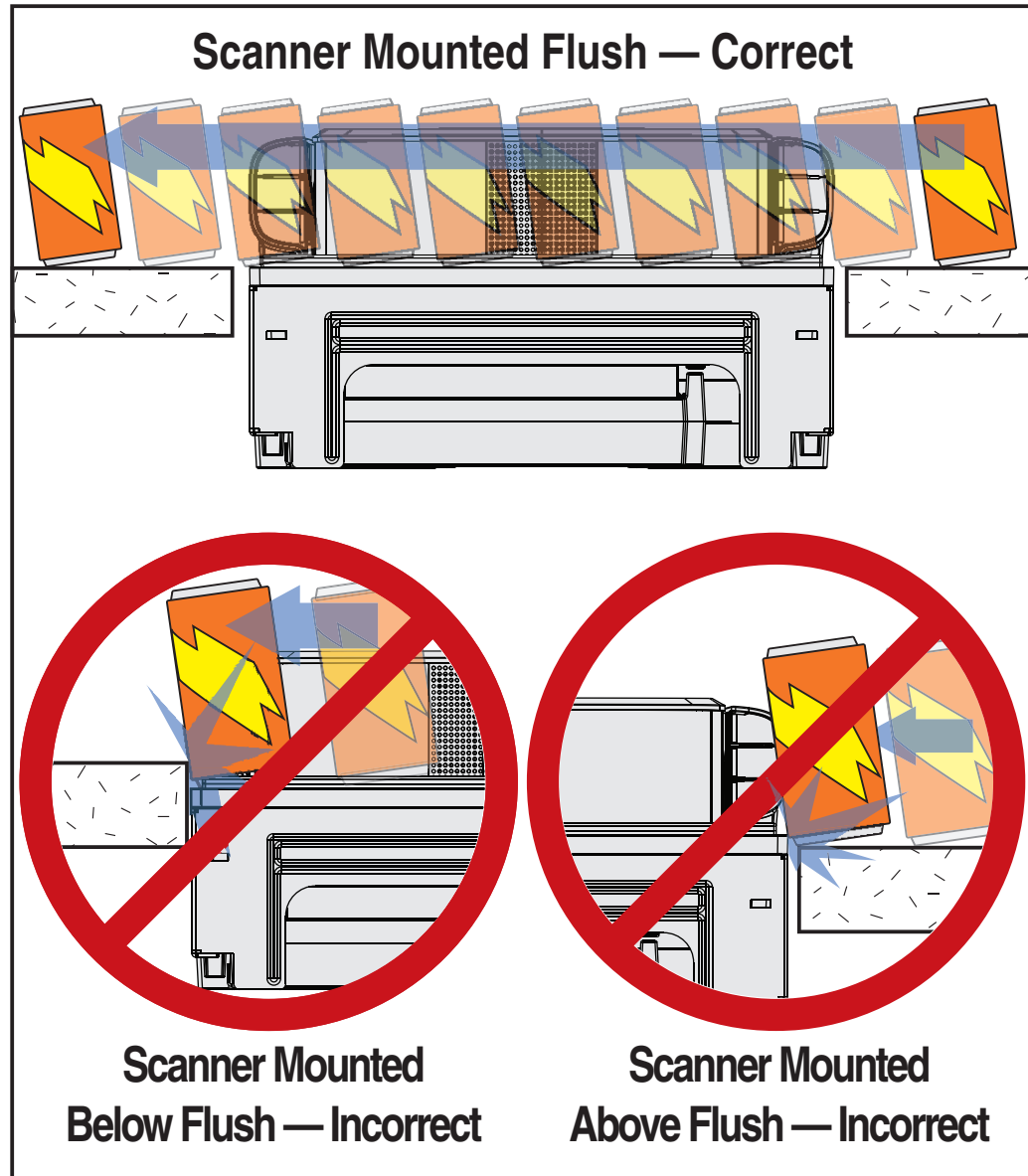

Refer to the appropriate drawing for cut-out and dimensional information on the model you'll be installing:

Model	Description	Cutout Dimensions	Reference Dimensions
9801	Short Shelf Mount Scanner	Figure 17	Figure 18
9803	Medium Shelf Mount Scanner	Figure 19	Figure 20
9804	Medium Shelf Mount Scanning-scale	Figure 19	Figure 20
9805	Long Flange Mount Scanner	Figure 21	Figure 22
9806	Long Flange Mount Scanning-Scale	Figure 21	Figure 22

Figure 17. Model 9801 (Short Scanner Model) Cutout Dimensions

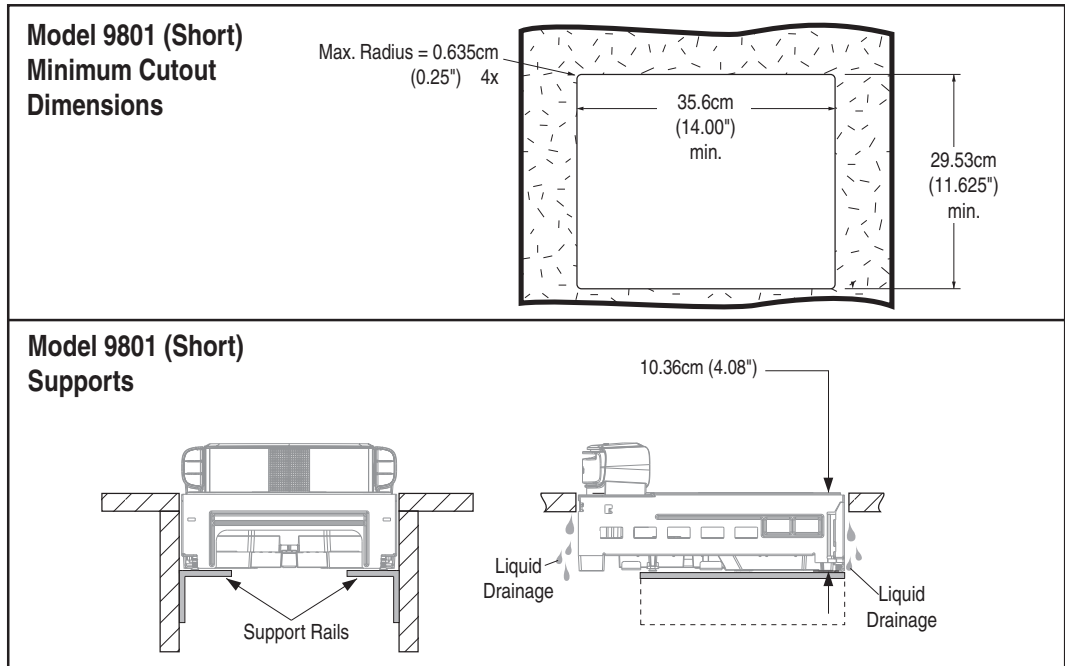

Figure 18. Model 9801 (Short Scanner Model) Reference Dimensions

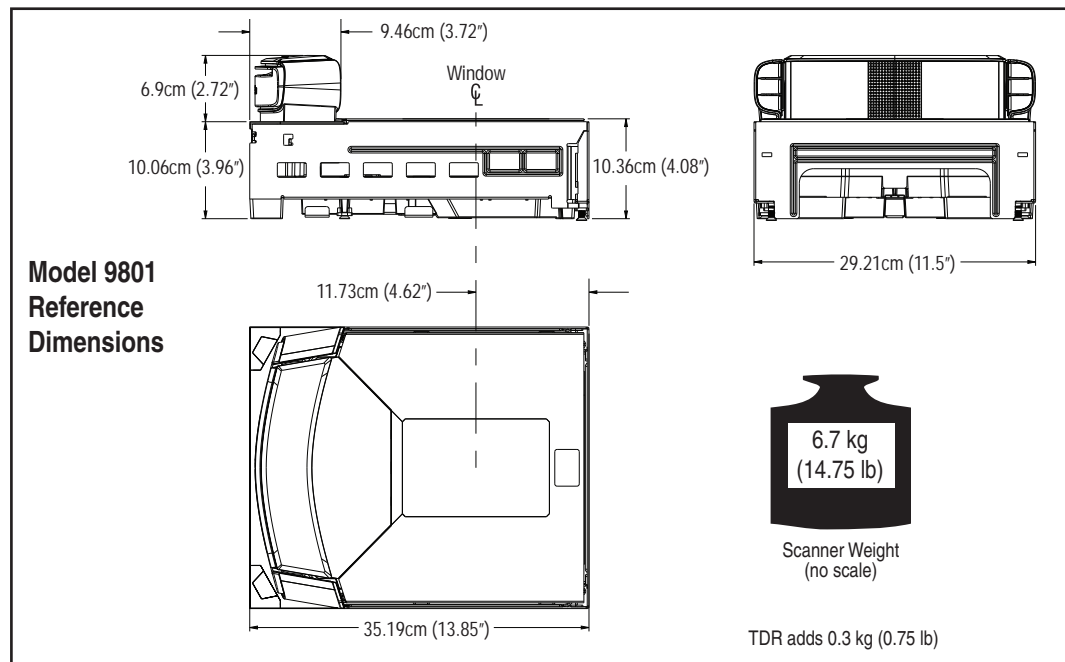

Figure 19. Models 9803 and 9804 (Medium Scanner or Scanning-Scale) Cutout Dimensions

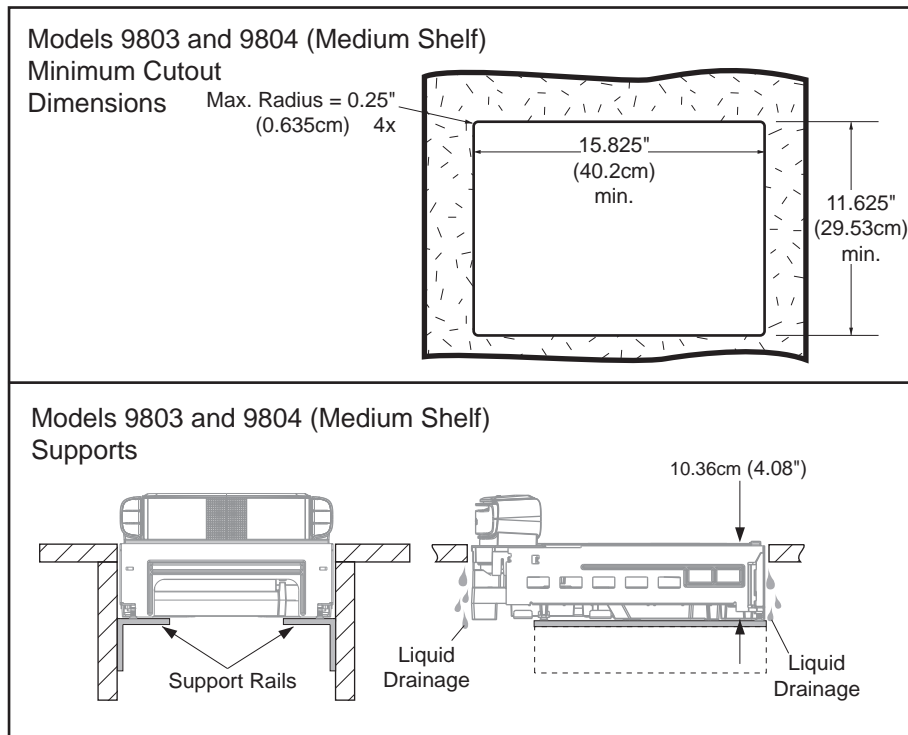

Figure 20. Models 9803 and 9804 (Medium Scanner or Scanning-Scale) Reference Dimensions

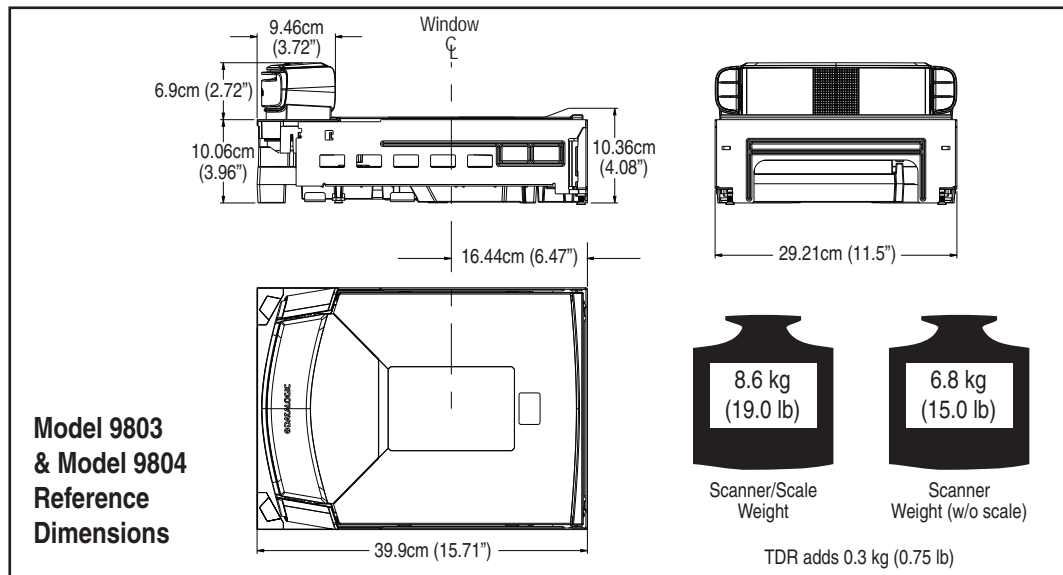

Figure 21. Models 9805 and 9806 Long Scanner or Scanning-Scale Reference Dimensions

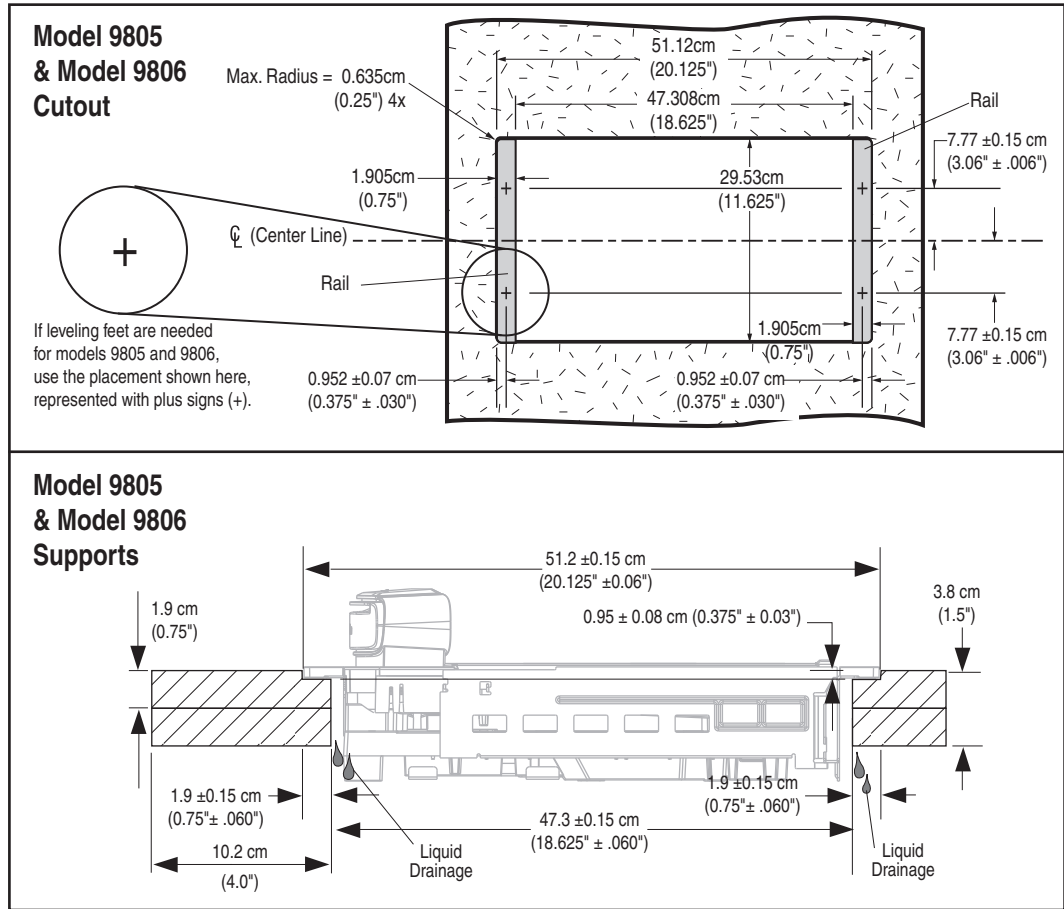
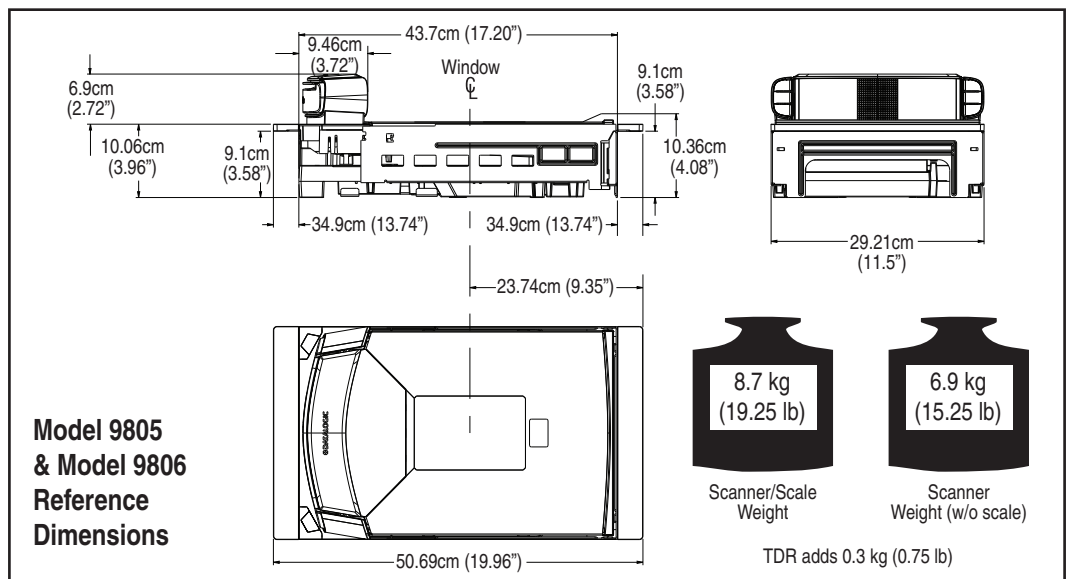

Figure 22. Models 9805 and 9806 Long Scanner or Scanning-Scale Reference Dimensions



Checkstand Mounting

There are a number of things to take into account when installing the unit into a checkstand. Key factors are ergonomic/worker safety, loading capacity and stability. Don't forget to add the scanner or scanning-scale's weight when calculating materials and supports needed to construct a sturdy installation, as well as maximum capacity of weighed and scanned items.



NOTE

If you choose to rout a countertop with a thickness of 0.75" (1.9 cm) plywood, you'll need to add a backing strip that supports the area routed out for the support flanges (see [Figure 14](#)). This support strip should minimally be made of 0.75" (1.9 cm) thick plywood and be approximately 4.0" (10.2 cm) wide and 14.0" (35.6 cm) long. This strip should be glued as well as screwed to the underside of the countertop.

Installation Overview

The preceding [Site Preparation Overview](#) dealt with installed location and counter preparations to accommodate the scanner or scanning-scale. Having completed those steps, physical installation of the scanner or scanning-scale can begin. The following instructions apply to all models.

This section describes:

1. Unpacking the unit.
2. Verifying operation before connecting to a POS system.
3. Routing and connecting cables.
4. Validating that your scanner communication parameters match the POS terminal's system requirements.
5. Confirming connection to the EAS system.
6. Functional testing to verify operation when connected to the POS system.

The following text describes each of these steps.

Unpacking

To unpack the unit:

- Inspect the package for signs of damage that may have occurred during shipping. If damage is found, report it to your carrier immediately.
- Lift out the accessory box containing the AC/DC Power Supply, optional Remote Scale Display and cable (if present), and the Quick Reference Guide.
- Remove the Quick Reference Guide and familiarize yourself with the unit's controls and features. Leave the guide at the checkstand when the installation is complete.
- Remove the protective packing and carefully lift the unit from the carton. Be sure to save the box and all packing material. In the event of failure, the unit must be returned to the factory in its original packaging.
- Carefully lift off the All Weighs™ Platter as shown in [Figure 33](#) and remove the protective foam pieces securing the weigh mechanism. Set the platter back in place.



For added protection during shipment, the All Weighs™ Platter is covered with a tight-fitting layer of vinyl as shown in [Figure 23](#). This vinyl layer **MUST BE REMOVED before placing the unit into service.**

NOTE

Also, if the unit is equipped with a scale, the scale spacer (below the platter) must be removed prior to use.

Figure 23. Remove Protective Vinyl

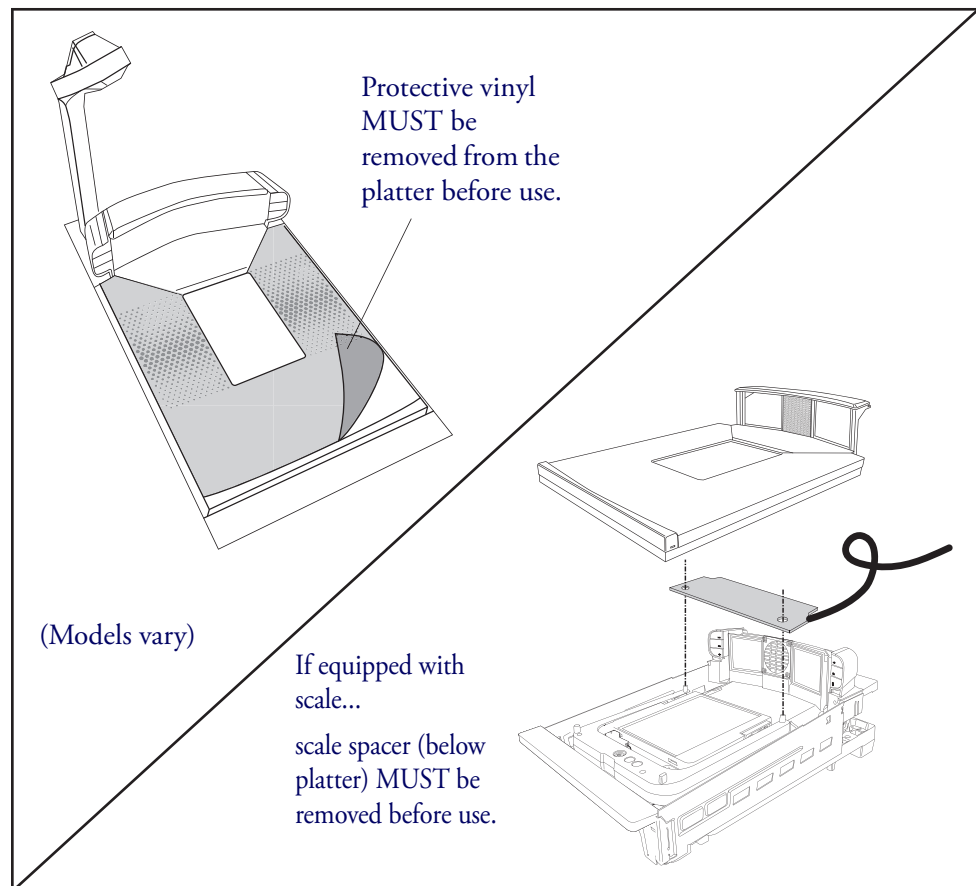

- Proceed to the [Operational Verification](#) instructions below.

Operational Verification

Follow these steps to ensure that your unit has arrived undamaged and is fully functional before installing it in the counter and connecting it to your POS system.

1. If the unit is a scanning-scale, connect the Remote Scale Display to the proper connector on the unit's connector panel (refer to [Figure 28](#)).



NOTE

if the Remote Scale Display is not connected, a scanner power-up Selftest will sound a long, low beep, and the number "8" will appear on the Health & Status Indicator (see [Figure 24](#)) indicating a remote display error. Power-down, connect a known-good Remote Display to the appropriate port, and restart to correct this problem. Alternatively, you can disable the Remote Display using programming bar codes (see [Chapter 7. Programming](#), for more information).

Figure 24. Viewing the Health & Status Indicator

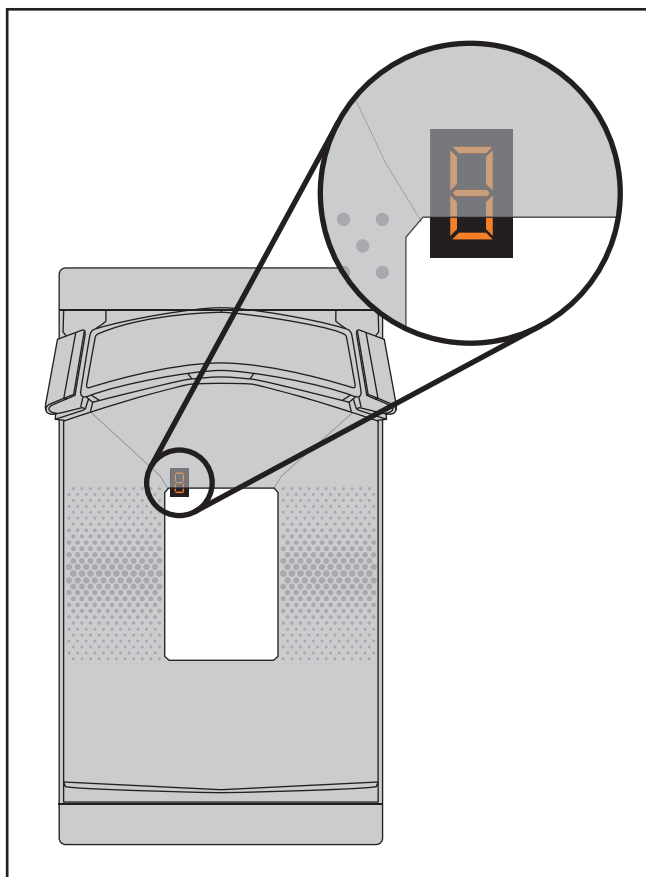

2. Connect the power cable, first at the scanner, then at the AC outlet.

When power is applied to the unit, the normal indicator sequence is:

- The good read indicator LEDs will be lit (dim) steadily.
- [EAS models ONLY] The EAS ((0)) indicator LED will flash ON/OFF during power-up.

-
- Additionally, the Health & Status Indicator will flash the number ‘9’, indicating the EAS system is being initialized.



CAUTION

If the Selftest detects a problem, the Health & Status Indicator will display a number code. Refer to Chapter 5. Problem Isolation, for a description of failure codes and problem isolation procedures.



NOTE

On rare occasions, performance of scale calibration may be necessary to obtain a zero reading on the display.

3. The unit should be permitted to reach thermal equilibrium before proceeding to the next steps. (Reference the topic [Warm-Up Time](#) in [Chapter 1](#).) When the unit is moved from a cooler temperature (such as a storage area) to a warmer environment (such as a check-stand location), a period of 60 minutes must be allowed to acclimate the unit to ambient conditions. Once installed and powered up, a “power-up” warm-up period of 15 minutes must be allowed before calibrating or performing weighing operations. These two warm-up periods may run concurrently.
4. Verify that the scanner or scanning-scale passes an operational test by observing the following:

Scanner — Pass UPC/EAN bar code labels in front of the scanner’s windows. Since the interface cable is not yet connected to the POS terminal, the scanner may be limited to reading only one or two labels (see the note that follows). The scanner indicates when each label has been successfully read by flashing the green scanner light and emitting a good read tone (beep).



NOTE

When not connected to the host, the scanner may be limited to reading only one or two labels. (This limitation is dependent upon the interface type.) To scan multiple labels without connecting to the host, place the unit in Scanner Diagnostic Mode by pressing the Scanner Control Button for four seconds.

EAS System — The way in which EAS tags are deactivated is dependent upon the way the scanner is currently programmed with regard to EAS Mode. (See “EAS Mode” on page 42.) To test EAS system function...

- **Coupled Mode** — Pass an item containing both a bar code and an active EAS tag over the scanner. Successful deactivation is indicated by the bottom-most LED flashing first red, then orange, then returning to green. The beeper will sound a good read beep. If you have enabled the manual deactivation function available for Coupled Mode (see “Manual EAS Deactivation Push Button” on page -48), test the function by pressing the bottom push button. A ticking sound will be heard which should cease upon deactivating an EAS tag.
- **Decoupled Mode** — In this mode, items do not require a bar code to be scanned to arm the deactivation function. Simply pass an active EAS tag over the scanner in the same direction you would scan a bar code. The bottom-most LED will flash red to indicate deactivation. No beep is sounded to indicate deactivation in this mode.

- **Hybrid Mode** — In Hybrid Mode, the scanner must be enabled, however EAS deactivation in this mode also takes place without needing to scan an item's bar code. Pass an active EAS tag over the scanner in the same direction you would scan a bar code. The bottom-most LED will flash red, then orange, then return to green. The beeper may be configured to sound a high frequency beep to announce successful deactivation.

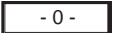
Scale — If the yellow scale indicator LED is not lit, press the Scale Zero  Button momentarily. If the scale is operating correctly, the yellow LED will illuminate and remain on steady, and the display will show a reading of 0.00 lb (0.000 kg for metric). If the display is blank or a  is displayed, it may be necessary to calibrate the scale before continuing. Refer to "[Calibrating the Scale \(Pounds & Kilograms\)](#)" starting on page 78, for calibration procedures.

Remote Scale Display — Check to verify that 0.00 lb (0.000 kg for metric) is displayed, then place an item on the weighing platter. Verify that the display shows a weight and that the yellow LED goes out. Remove the item and observe that Remote Scale Display shows 0.00 lb (0.000 kg for metric) and that the yellow LED is On.

5. Unplug the AC power cord from the outlet and disconnect the power cord and Remote Scale Display cable from the scanner's connector panel.

After you have verified that the scanner and scale (if present) are completely functional, continue with the following procedures to complete the installation.

Diagnostic Modes

Two diagnostic modes are available which allow you to initiate scanner or scale diagnostic tests, as well as verify the scanner's ability to read bar codes.

Scanner Diagnostic Mode

While in Scanner Diagnostic Mode, continuous scanning of labels is allowed, permitting the user to scan an unlimited number of bar codes while troubleshooting problems. Under normal operation, the scanner stores label data, awaiting the signal which transmits it to the host. When the scanner is not connected to a host, it may read and store only up to two labels, then quit reading until power is cycled (clearing the memory). This mode of operation removes this limitation.

To place the scanner in Scanner Diagnostic Mode, press the Scanner Control Button for five to nine seconds. While pressing the button, the scanner will first sound three tones, wait a few seconds, then sound six rapid tones; after which you should immediately release the button. For more details about the Scanner Control Button and audio indications, see [Appendix A, LED/Audio Indications & Controls](#).

While in Scanner Diagnostic Mode, identification numbers for interface¹ type, firmware and configuration will scroll continually across the scanner's Health & Status Indicator (Field Replaceable Unit) display. This is useful information for field diagnostics. See [Figure 40](#) for the location of the display. For example, if the dual cable RS-232 interface (type 05) were enabled, the firmware designation was R96-1234, and the configuration was R96-5593, the following would be shown (slowly, with blanking between each of the items):

IF-05 r96-1234 r96-5593.

1. A listing of scanner interface identification numbers is available in [Chapter 11](#), under the topic, [Interface Type](#).

To exit Scanner Diagnostic Mode, cycle power to the unit or press and hold the Scanner Control Button for ten seconds to reset the scanner. See the topic, [Scanner and Scale Reset](#) in [Chapter 3](#) for more information about unit resets.

Scale Diagnostic Mode



The scanner must be configured to allow Scale Diagnostic Mode. See the [Programming](#) section for details.

NOTE

To enter Scale Diagnostic Mode, press the Scale Service Button (this is the same button as ScaleSentry) for approximately four seconds. Six rapid tones will be sounded, indicating the unit is leaving normal operation and entering Scale Diagnostic Mode.

Health & Status Scale Diagnostics

Upon entering Scale Diagnostics, the Health & Status indicator¹ will then sound one medium length beep and display a sequence of characters indicating the following information:

Table 3. Scale Diagnostic Health & Status Indications

CHARACTERS	EXPLANATION OF INDICATION
c x	Where x is the number of calibrations performed to the scale.
≡ x	Where x indicates the number of times the scale has been zeroed.
== x	Where x indicates the scale gravity zone.
- xxxx	Where xxxx is the load cell software checksum in hex lower 4 characters.
- x	Where x indicates the scale software revision.
xxxx	Data area reserved.
zzzz zzzz	Scale weighing package identifier and signal processing identifier if present.
ucustomdata	Is the value of a custom data string (if present — no data may be displayed if the item value is not set.
The sequence will be repeated	
H	Upon successful completion, the scanner will automatically reset, displaying an H.

If the diagnostics routine is not completed successfully, the scanner will sound a series of tones and the Health & Status indicator will show an error code. Turn to [Chapter 5, Problem Isolation](#) for a description of error codes.

Press the Scale Zero Button once more to reset the unit and exit Scale Diagnostic Mode. See the topic, [Scanner and Scale Reset](#) in [Chapter 3](#) for more information about unit resets.

1. The Remote Display (if one is present) can additionally display some scale diagnostic information.

Optional Remote Display Scale Diagnostics Indications

If your unit is equipped with an optional Remote Display, it will show the following sequence, with each character being separated by a 500ms or greater blank time on the display (for ease of reading). This display continues to scroll across the display until the scanner changes state or is reset.

Table 4. Scale Diagnostic Remote Display Indications

CHARACTERS	EXPLANATION OF INDICATION
PASS or ERRx	Where x is 1 through 5.
All segments on the display are illuminated.	
▷0◁ x	Where x indicates the number of scale zeroing attempts.
c x	Where xx represents the number of calibrations, with a maximum of 999 displayed.
— x	Where x indicates the scale gravity zone.
xxxx	Where xxxx is the load cell software checksum in hex lower 4 characters.

Cables & Connections

Considerations when routing the power and interface cables for the scanner and scanning-scale are:

- Ensure that cables are not pinched, kinked or pierced.
- Do not route interface cables in close proximity to electrical motors or other sources of electromagnetic interference.
- Cables can drop directly from their connectors on the scanner, or, alternatively, can be routed along the scanner's side to the back (see [Figure 25](#)).

Do not plug the AC power cord into the outlet at this time. It is a good practice to always connect the power cable to the scanner first before plugging it into the AC receptacle. The procedures titled, Set-Up, provided later in this section will instruct you to connect the power cord at that time. [Figure 25](#) illustrates the basic cable routing scheme.

Figure 25. Cable Routing

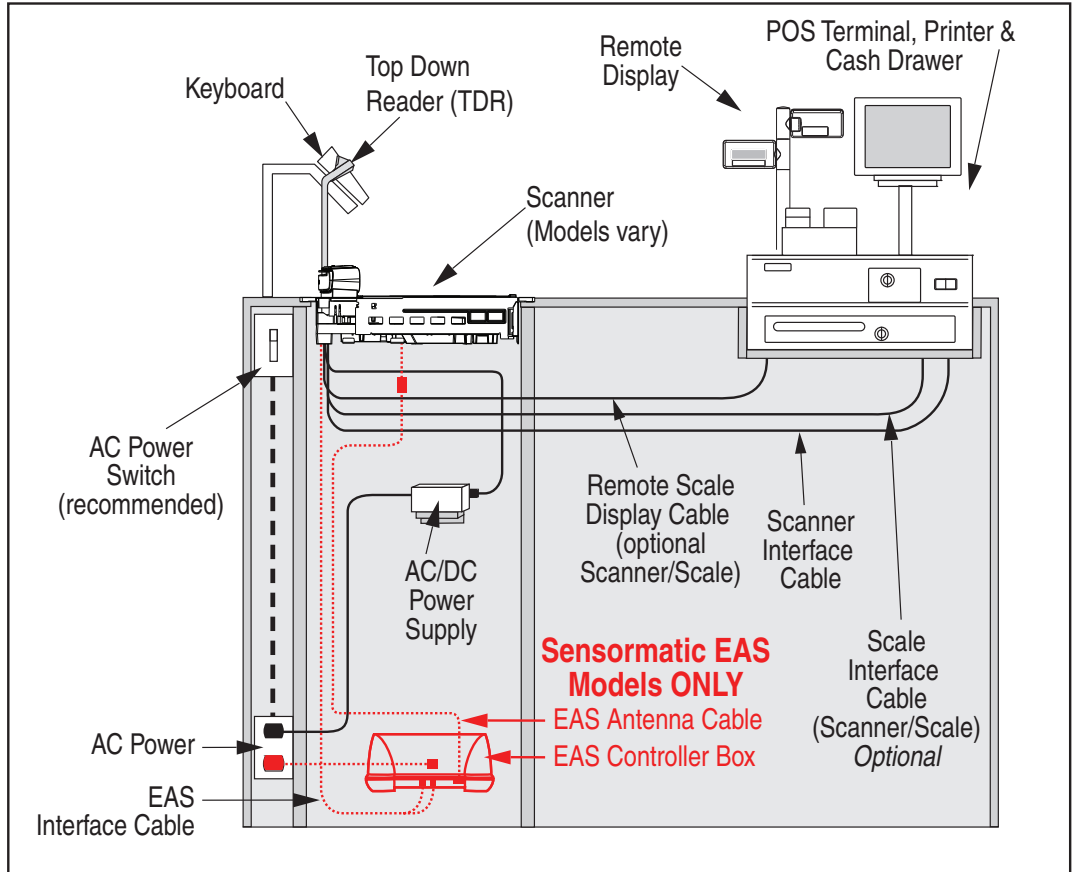
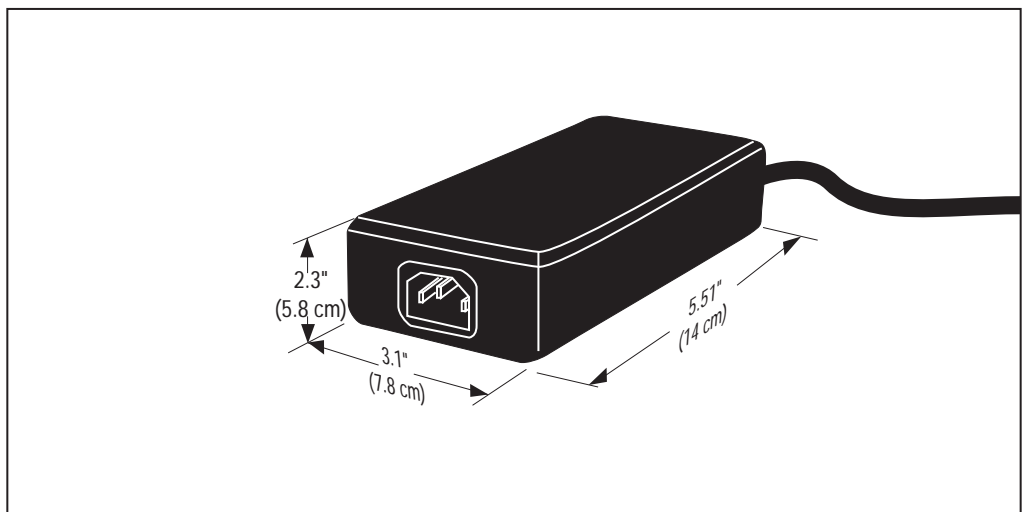

Figure 26 provides physical dimensions for the AC/DC Adapter (part number 8-0599).

Figure 26. Physical Measurements: AC/DC Adapter



Remote Scale Display Placement/Installation

When installing the optional Remote Scale Display, consider both the customer's viewing angle and the amount of daily ambient light conditions anticipated at this installation site. [Figure 27](#) shows available adjustment for the display head.

Lighting Considerations

The display(s) will be easily readable unless placed in direct sunlight or other very strong light sources. Light interference will not be a factor in most installations. For best viewing, the display head(s) can each be rotated up to 180° around the post and/or tilted 15° backward or forward.

Viewing Angle

The optimum display angle is directly facing the viewer. Tilt and rotation adjustments can be made for the Remote Display models as shown in [Figure 27](#). To ensure that displays are easily readable for customers/cashiers of average height, display heads should be between 48" to 60" (122 to 152 cm) from the floor.



Check with local Weights and Measures authorities regarding proper positioning of scale displays used in retail trade.

NOTE

Figure 27. Modular/Adjustable Remote Scale Display

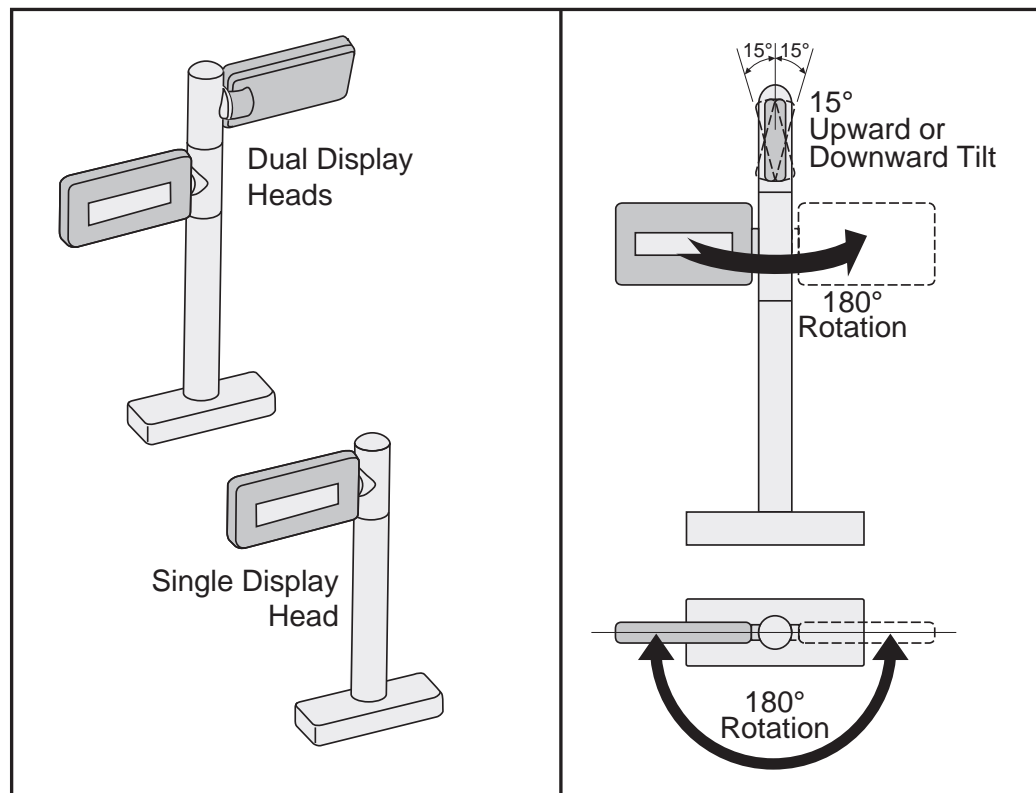

Remote Display Cabling

Your installation should also take into account the routing of Remote Display cabling. Ensure that distance and obstacles spanned by the routed cable will not kink, pinch or stretch it. Also keep in mind you may need to drill a hole through which to route it.



NOTE

The Remote Scale Display connector end may be secured with a rubber band during shipping to prevent damage to the “locking tabs”. After routing the cable, remove this rubber band before connecting. Failure to remove the band will keep the connector from latching properly.

Placing and Installing the Remote Display

Reference [Figure 29](#) while performing these procedures.

1. Determine where you want to install the Remote Scale Display based on your counter design, the viewing angle, lighting considerations and cable routing discussed previously. Reference [Figure 28](#) for the display’s physical dimensions. Optimally, the display(s) should be approximately eye level to the viewer(s).
2. Use the template provided in [Figure 30](#) to mark locations of the mounting screw and cable routing holes.
 - The mounting screw holes are on 3-1/2” (85.1 mm) centers. The cable can either be routed through a 3/4” (19 mm) diameter hole directly under the mounting base or through the cutout in the back of the base (see [Figure 29](#)).
3. Drill the mounting screw holes using a drill bit of the appropriate diameter for your mounting screws or bolts.
4. Drill the cable routing hole using a 3/4” (19 mm) drill bit (optional).

Figure 28. Remote Display Physical Measurements

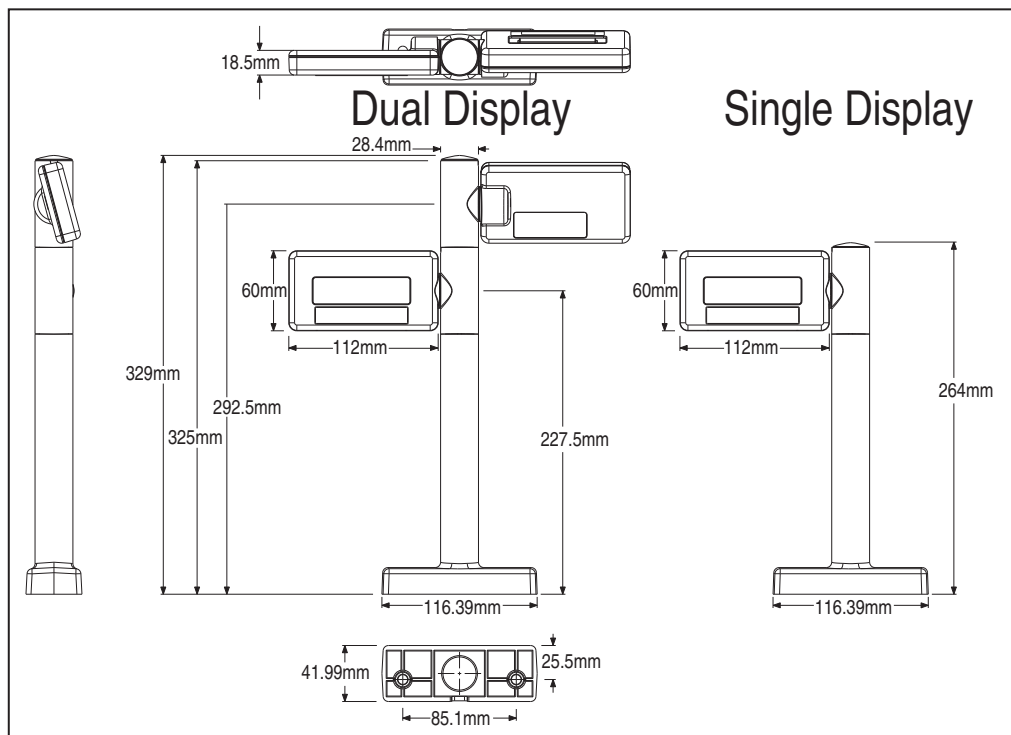

5. Feed the entire length of the Remote Scale Display interface cable through the cable routing hole so that the assembled Remote Scale Display can be positioned over the mounting screw holes.
6. If present, remove the rubber band from the connector end.
7. Install mounting screws or bolts to complete the installation of the Remote Scale Display. Take care not to pinch or pierce the interface cable while securing the Remote Scale Display to the checkstand.

Figure 29. Remote Scale Display Mounting

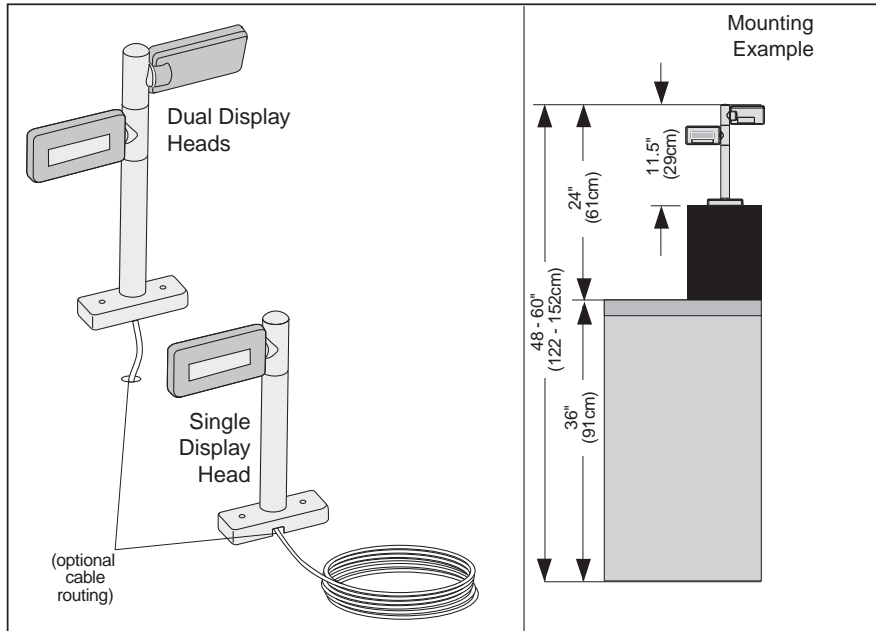
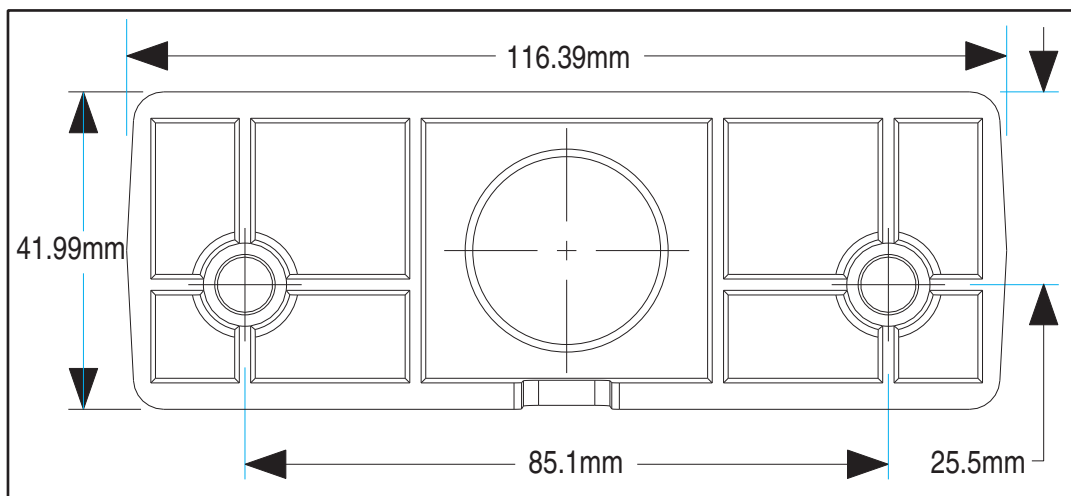

Figure 30. Remote Scale Display Mounting Template



Changing Weighing Modes

Your scanning-scale has been programmed for weighing in either pounds or kilograms depending upon the initial operating environment that was specified when you ordered your scanning-scale. If you need to change from pounds to kilograms or vice-versa, call [Technical Support](#).

You can verify that the scale is set correctly for your country's requirements by observing that the Remote Scale Display shows the appropriate measurement symbol (lb or kg) when the power-up Selftest is completed.

LEGAL NOTE

Any time the scale weighing mode is changed, the scale must be re-calibrated before commercial use.

Set-Up & Installation

These setup and installation procedures assume that you have already prepared your checkstand to receive the scanner or scanning-scale. If you have not already made the counter cutout and routed power and interface cables, do so now as described in the previous instructions. If your checkstand has been prepared, proceed as follows:

Set-up

1. Place the unit on the checkstand next to the counter cutout.
2. Route the cables up through the cutout and connect the scanner and scale interface cable(s), and Remote Scale Display cable (optional) to the scanner. Some POS terminals require two interface cables; one for the scanner interface and one for the scale interface. Refer to [Figure 31](#) for cable connection locations. The appearance of the connector panel will vary depending upon the factory options purchased with your model.

If you have a scanner with no scale, there will be only one interface cable to the POS terminal.

3. Connect the power cord to the scanner and route the other end down through the checkstand to the AC power outlet. **DO NOT** plug the power cord in at this time.
4. **OPTIONAL** — Route your EAS antenna cable down through the checkstand cutout. (Reference your EAS controller's set-up instructions for proper EAS antenna installation.)

Figure 31. Connecting Cables to the Scanner/Scale

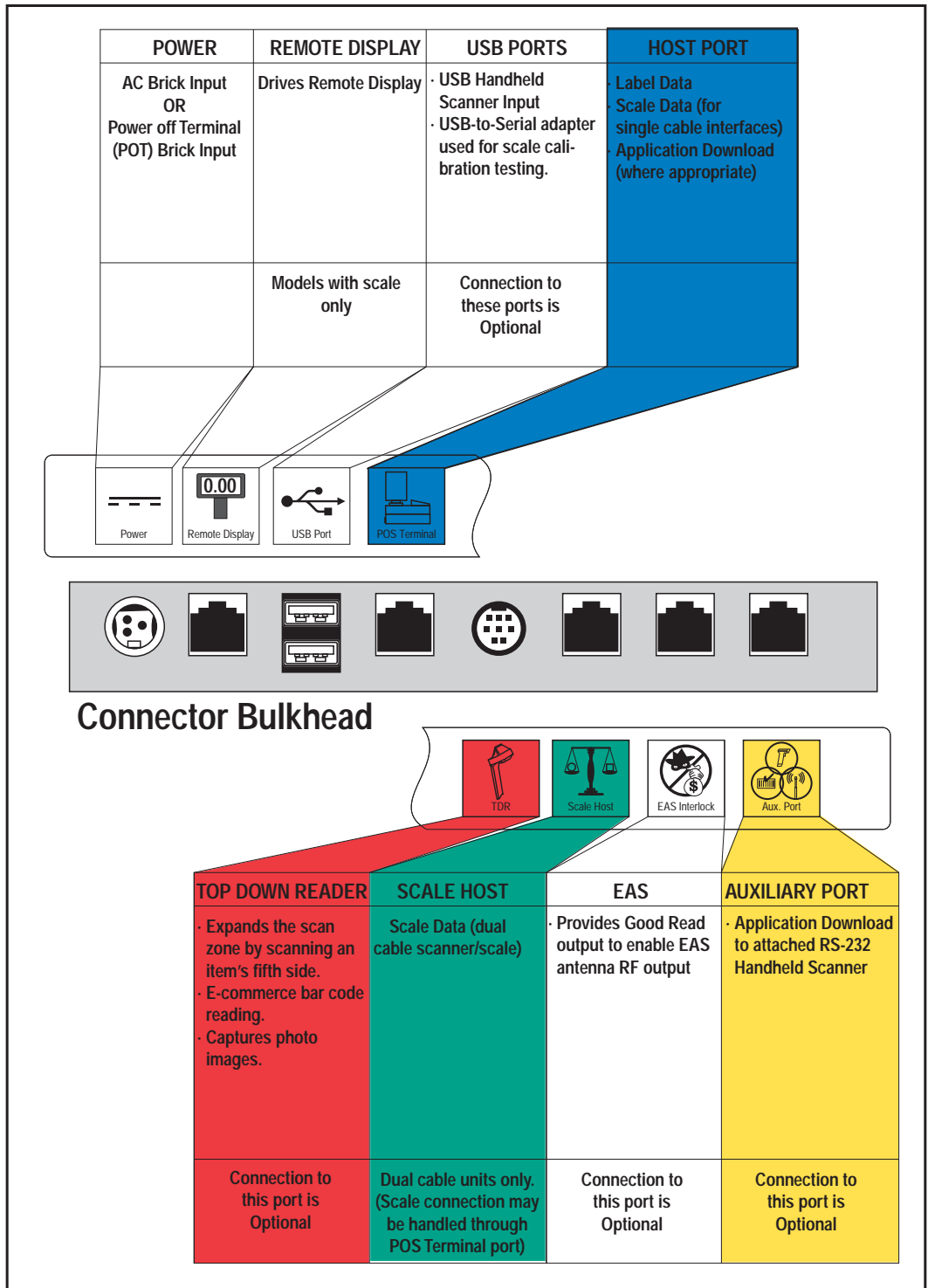
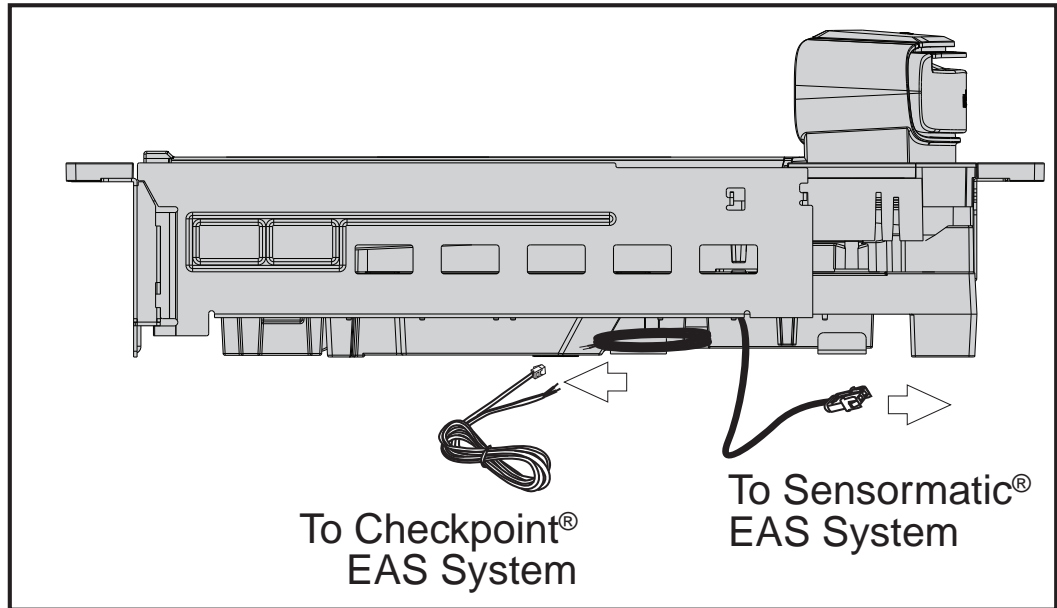
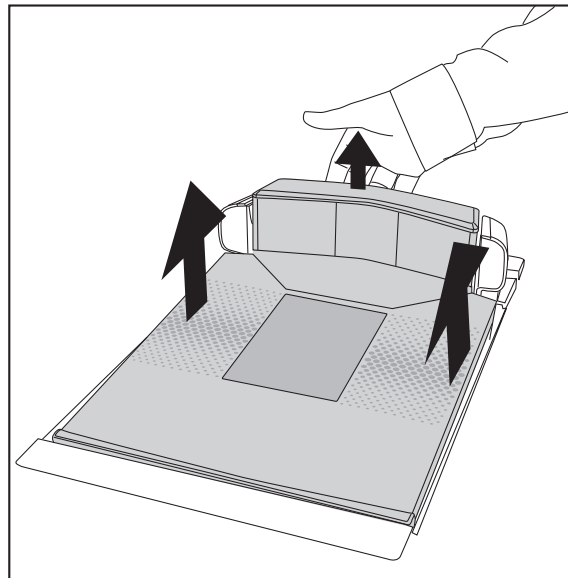

Figure 32. Optional EAS Cable Connections



5. Make sure that all cables are firmly attached (except that the AC/DC power supply should not be connected to the AC outlet yet).
6. Remove the All Weighs™ Platter to gain access to the lift handles. Lift the top edge of the platter bezel as shown in [Figure 33](#) and gently lift it from the scanner. If the top edge of the platter is blocked, you may find it easier to grasp edges of the platter as shown by the arrows.

Figure 33. Removing the All Weighs™ Platter



7. The scanner provides lift handles that must be rotated up into position for use as shown in [Figure 34](#). When released, these handles should be allowed to rotate back down into their seated positions in the cavity. Use reasonable care when attempting to lift the unit using any features other than the lift handles.

Figure 34. Using the Lift Handles

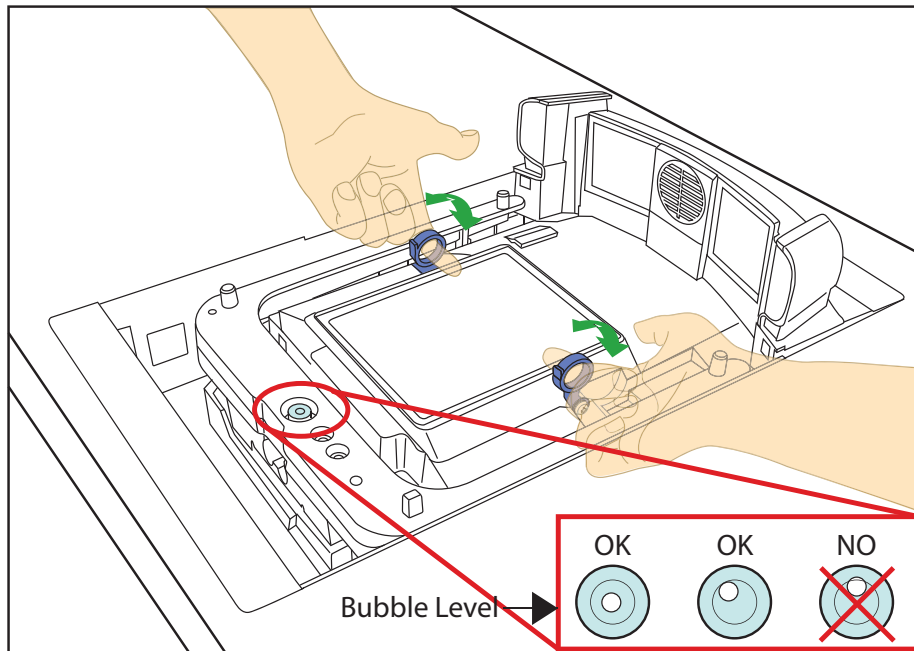

8. Lower the unit into the counter opening, ensuring that none of the cables are pinched, pierced or crimped.
9. View the bubble level (if present¹) located on the scanner's spider assembly to ensure the scanner is level. As shown in the insert of [Figure 33](#), the air bubble should appear fully within the circle indicated. The air bubble can touch the circle, but must not overlap it. Apply shims beneath the scanner flange or adjust the leveling feet to allow level installation.
10. Reinstall the All Weighs™ Platter and verify that it is flush or just below flush with the countertop. This is necessary to provide smooth scanning from either direction. Make adjustments as needed to align the platter with the counter by moving support rails up or down, or consider installing screws in positions that will allow their use in adjusting the unit's position. Ensure that leveling is maintained if adjustments are made.



Failure to install a scanning-scale in a stable and level position will inhibit weighing, calibration and zeroing operations. The platter MUST make unobstructed contact with all of its supports for proper weighing operation.

NOTE

11. Once installation is complete, proceed with the [Operational Verification](#) procedures that follow.

1. The bubble level is present only on certain models.

System Power-Up Recap

The System Power-Up procedure may vary depending upon the requirements of your POS system. It is generally a good practice to power-down (switch off) all equipment prior to connecting cables. Check with your System Supervisor and/or refer to your POS terminal manual for proper power-down and power-up procedures and interface requirements when connecting any peripheral device.

If you have not identified any specific requirements for your POS system, follow these steps.

1. Power-down the POS terminal.
2. Ensure that power is disconnected from the scanner.
3. Connect the scanner and scale interface cables to your POS terminal. This connection may use one or two cables depending upon your POS terminal interface.
4. Connect the Remote Display cable if your model is a scanning-scale and make any connections to optional equipment, such as EAS¹ or a handheld scanner.
5. Power-up the scanner or scanning-scale by connecting the power cord to an AC power outlet. Wait for the unit to complete the Selftest routine (10 seconds maximum).
6. Power-up the POS terminal.
7. Verify that both scanning and weighing data are properly communicated between the scanner and your POS system. (Weigh, deactivate² and scan a few items.) If problems are encountered, refer to [Chapter 4, Problem Isolation](#).
8. You have now completed installation and system integration of the scanner or scanning-scale. At this point, the scale must be calibrated and certified in accordance with the requirements of your state and/or local requirements. Refer to [Chapter 6. Calibration Procedures](#) for calibration details.

1. Some peripheral equipment must be connected or powered on in a specific order. Check the equipment instructions to verify the correct sequence.
2. Test EAS deactivation only if applicable for your model.

NOTES

Chapter 3

Operation and Maintenance

The information contained in this section describes how to operate and maintain the scanner, scale and EAS system. Topics include “how to’s” on scanning, EAS tag deactivation, weighing, re-zeroing the scale, removing the top cover and cleaning the upper and lower windows.

Scanning Items

To scan items, slide or push them over the scanner as shown in [Figure 35](#). Also see [Figure 4](#) for views showing the scan zone. The scanner will work equally well with either a left-to-right or right-to-left motion through the scan zone. There is no need to reorient an item’s bar code since the scanner and its Top Down Reader (TDR) can read the left, right, front and back side, as well as the top and bottom of an item.



“Limited Scanning Mode” is entered by default by interfaces such as USB and IBM until a Point Of Sale (POS) terminal enables scanning. Labels are “chirped” while in this mode.

NOTE

Figure 35. Scanning an Item

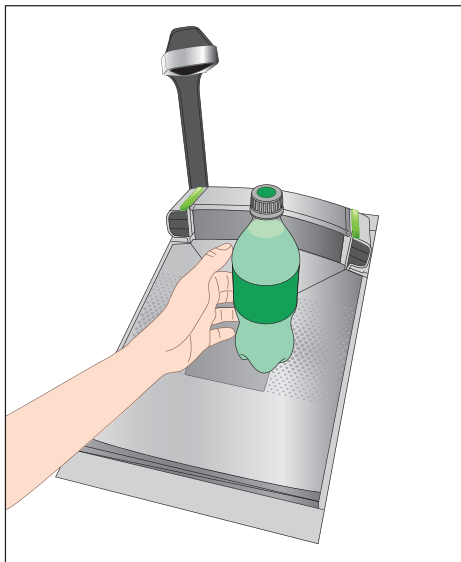

Proper Scanning Technique

The scanner was designed to provide the ultimate in ergonomic enhancements for Point-Of-Sale (POS) scanning. To take advantage of these advancements:

Practice the techniques below to improve scanning efficiency:

- Move the product across the horizontal window (See [Figure 35](#)).
- Since the scanner reads labels on all four sides plus the top and bottom, don't favor either the horizontal or vertical scan windows. Keep items in their natural orientation.
- Remember to slide or push items rather than picking them up. By avoiding any gripping, twisting and rotation of your hands and wrists, you can prevent repetitive motion injuries. This technique also relieves you from lifting possibly thousands of pounds per day.
- Develop a smooth fluid motion during scanning, sharing work equally between hands.
- Use the entire hand for grasping and lifting items.
- Develop efficient scanning motions, not necessarily faster hand movements.
- Learn typical locations for bar codes on packages; avoid "flipping" or rotating the items during scanning.
- Learn how the scanner functions and where the scanning area is located.

Proper Weighing Technique (Scale Models)

1. The L-shaped All-Weighs™ platter allows you to place items anywhere on its surface, including leaning against its vertical section, to be weighed accurately. The raised lip on the end also provides a convenient way to ensure items do not rest on the counter or other non-weighing surfaces. (Reference [Figure 36a](#).)

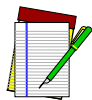

NOTE

It is important that items rest entirely on the platter for their full weight to be accurately recorded. An optional ScaleSentry™ feature can be employed to help prevent the occurrence of item overlap onto non-weighing surfaces. See the following section for more information about this feature.

Figure 36. L-Shaped Platter, Item Placement and ScaleSentry™

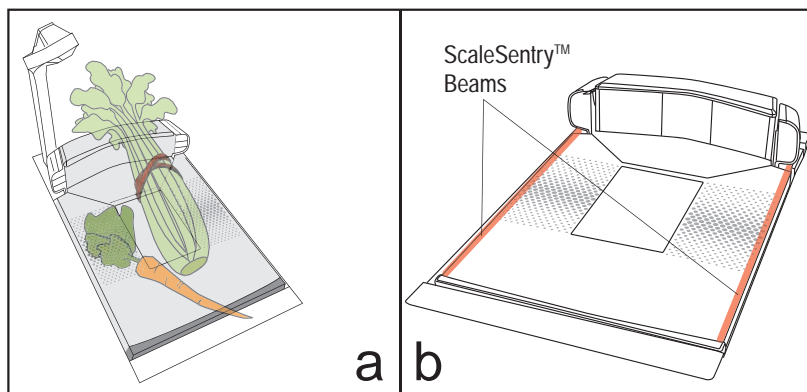

2. Once weighed items are in place, enter PLU (price Look-Up) data as described in your POS system instructions. Item weight is displayed on the Remote Display and/or the host display.
3. Remove the item from the weigh platter.

Using the Optional ScaleSentry™ Feature

If the scanning-scale has been equipped with ScaleSentry™, infrared (IR) beam(s) are emitted along one or both long edges of the platter (See [Figure 36b](#)). During the process when items are being weighed, if an item approaches too closely or extends past the edges of the weighing surface, this is detected by the IR beam(s) and the scanner will indicate a ScaleSentry event by illuminating its ScaleSentry indicator LED and/or sounding a special ScaleSentry tone. These indications are configurable, and can be enabled or disabled using the [Programming](#) section of this manual.

Depending upon how ScaleSentry is configured, a scale transaction cannot be completed until: 1) The item(s) are physically repositioned to rest fully on the platter without overhanging the side, or until 2) The ScaleSentry button is pushed, overriding the condition, or 3) It can also be configured to only indicate the error, but still transmit the weight to the POS.

Deactivating Security Labels

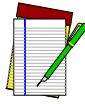

NOTE

Two different types of Electronic Article Surveillance (EAS) systems can be optionally enabled for certain scanner models. Your system may or may not be equipped with EAS deactivation functionality.

Checkpoint

Checkpoint® systems require a wired connection as shown in [Figure 2](#). When this system is armed, Checkpoint EAS-tagged items are automatically deactivated as they are slid over the scanner's platter area during scanning.

Sensormatic

Sensormatic® Ultra-Max®, Ultra-Strip® II and III EAS tags can be detected and deactivated by a system that is equipped to do so. This is accomplished by means of a deactivation antenna mounted under the scanner platter. EAS tags should be brought within five inches of the antenna to be deactivated.

EAS Deactivation Modes

Three modes of initiating deactivation are selectable via scanner programming (reference [Chapter 7, "EAS Mode"](#) in this manual):

- Coupled Mode — Deactivation occurs only after item bar codes are read by the scanner.
- Decoupled Mode — Deactivation is independent of the scanning function
- Hybrid Mode — The EAS system is armed whenever the scanner is enabled and the deactivation beep is sounded when an EAS tag is deactivated..



NOTE

The EAS system must be functional to implement any of the EAS Modes. If the EAS system is not active, error code 9 will be displayed in the Health & Status Indicator (see [Figure 42](#)).

EAS Deactivation Indicators

The scanner can be programmed to beep in acknowledgement of deactivation or upon deactivation failure. Additionally, the tri-color indicator (the bottom-most LED) displays

deactivation status. (For more information about Beeper and LED indications, see the LED/Beeper Indications & Controls section of this manual. Also reference the programming section for their configurable features.) By general default, LED indications are:

- Green means the system is ready (standing by).
- Red signifies the system has detected an EAS tag.
- Orange indicates an EAS tag is being deactivated.

Manual EAS Deactivation Push Button

The bottom-most push button is reserved for use in rare instances where EAS tagged items are not automatically deactivated when brought through the scan zone. This button is not intended for regular use. In instances where deactivation is not automatically triggered, hold the EAS tag directly downstream from the horizontal window, and press and release the Manual EAS Deactivation Push Button. This manual deactivation feature is optional, and can be enabled/disabled via the bar codes located in the programming section of this manual.

The item will be deactivated and a message to store management that this has occurred will be sent.

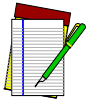

NOTE

In a case where an item's bar code is damaged or obscured by an EAS tag or other obstruction, the operator will need to key enter the bar code number and use the Manual EAS Deactivation Push Button to manually deactivate the EAS tag.

Deactivating the EAS System when failed

In cases of EAS system failure or malfunction, a scanner can be enabled to operate independent of the EAS deactivation function. This is accomplished by pressing and holding the EAS Manual Deactivation Push Button for three seconds. The scanner will sound three high-pitched beeps upon bypassing the EAS function in this manner. When in this state, the scanner's EAS LED will flash slowly red, as well as the FRU Status LED, which will slowly flash error nine (9).

Operational Controls

The function of scanner and scale controls and indicators is listed in [Appendix A, LED/Beeper Indications & Controls](#). Turn to that appendix for full details.

Operational Modes

The scanner or scanner/scale features a number of modes that are important to both the user and the system support personnel. These modes can be combined into three groups: pre-operational, operational, and additional functions. The following text describes these modes, what they mean, and how and when they are seen.

Power-Up/Selftest & Pre-Operation

Pre-Operation describes those steps that must be successfully completed before the scanner sounds the initial good read tone and illuminates the lamps indicating the scanner and/or scale are ready for operation. These steps include Power-Up Selftest, Error Reporting, and Operational Configuration.

Power-Up/Selftest

Power-Up Selftest begins when power is applied. The scanner's software immediately begins the testing sequence to verify that all systems are functioning properly. This routine, which only takes a few seconds, checks all the functions of the scanner, EAS deactivation system, scale, remote scale display and interface prior to indicating that it is ready for operation.



A tone indicating Selftest is complete is a configurable feature. See the Chapter 7, "Power-up Beep Control" in this manual.

NOTE

Error Reporting

If a fatal error is detected during Selftest or operation, the unit will not advance to Normal Operation Mode. Selftest diagnostics will cause the unit to sound a long, low tone and/or display an error message on the Health & Status Indicator indicating where the failure occurred. These messages are coded to assist the repair technician in identifying the failed component. If the error is with the EAS deactivation system, the bottom-most LED will flash red. If an error is indicated, make note of it and contact your supervisor or technical support representative. A table containing descriptions of these error codes is included in [Chapter 4, Problem Isolation](#).

If a non-fatal¹ error is detected (such as a EAS deactivation system error), the unit will sound a long, low tone and display a number on the Health & Status Indicator. The unit will advance to Normal Operating Mode, but performance may be affected until a correction or repair is made.

Operational Configuration

Once Selftest diagnostics have been successfully run, a tone is emitted (if configured to do so, and the unit enters an operational configuration state. The scanner or scanner/scale will automatically load your specific interface settings which are required to communicate with the host system. There are two conditions that must be met before the unit can enter Operating Mode:

- No bar code label can be in the scan volume while the unit is in this state. Progress is halted until the label has been removed, thereby ensuring that no extraneous bar code data is sent to the host.
- If your scanner has a scale, the scale cannot be in motion (usually caused by excessive vibration in the checkstand) for this test to succeed. A "Scale in Motion" status will be indicated by displaying a period and the applicable weight unit (lb . lb or kg . kg) that is selected.
- The scale must be able to "capture" zero weight. The display will be seen if there is a weight on the platter at power-up. Removing the weight or pressing the Sscale Zero Button should allow the scale to find zero.
- When the scanner or scanner/scale completes its Selftest successfully, it emits a tone (when configured to do so) and enters Operating Mode.

Operating Mode

Operating Mode includes Normal Operation (scanning, EAS deactivation and weighing) and Sleep Mode. These two modes are most commonly observed by the user/operator.

1. Scanner behavior under non-fatal error conditions is configurable. See [Chapter 7, Programming](#) for more details.

Normal Operation

This condition is indicated by the scanner green LED and the EAS deactivation LED both being on dim and steady. For scanner/scale models, the scale yellow LED indicates that the scale senses a weight of zero on the platter. If you have a scanner without scale model, the yellow lamp will not be lit when the scanner is ready for scanning.



Yellow and Green LED indications are configurable. Your scanner may not be programmed to operate in the standard manner described above.

NOTE

Once the scanner enters Normal Operation, it begins a countdown sequence. If there is no activity during a preset period of time (also called time-out¹), the unit will shut off in order to prolong the life of the electrical components. Once the scanner has timed out, it enters Sleep Mode.

Sleep Mode

After the scanner has been left idle for a preset period of time, the unit goes to sleep. This state is called Sleep Mode, and is indicated by a “slow” blink of the green light (blinking at a 2-second rate). To wake up the unit, press anywhere on the weigh platter (scanner/scale models only), press the Volume Selection switch or wave your hand in front of the vertical window. The unit will recognize any of these signals as a wake-up call and instantly return to Normal Operation.

Additional Functions

Additional scanner and scale functions include programming, running scanner or scale diagnostics, initiating a reset, zeroing the scale, and calibrating the scale.

Programming

When your scanner or scanner/scale is shipped from the factory it is configured to work with the POS system interface at your store and read the bar code symbologies you designated. If you need to change this configuration information for any reason, [Chapter 7, Programming](#), contains special bar code labels for changing the unit's settings.

Diagnostic Mode

Refer to [Chapter 2, Diagnostic Modes](#), for details about running scanner and scale diagnostics. Turn to [Chapter 4, Problem Isolation](#), for a description of error codes resulting from diagnostics.

Scanner and Scale Reset

The reset procedures and indicators are identical for scanner and scanner/scale models. As with any electronic equipment, it is sometimes necessary to reset the electronics. The reset procedure allows you to initiate a reset command to the scanner. This may be necessary if the POS

1. “Timeout” and “Sleep Mode” time delays are programmable features that can be selected through use of the programming labels included in [Chapter 7, Programming](#).

terminal has been switched off or the store system has been reset while the unit is on. Reset can also be used to initiate and run the unit's internal Selftest routine.

Pressing and holding the Scanner Control Button for ten seconds initiates a reset, which is sounded by a rapid number of beeps. For more information, see the topic, [Power-Up/Selftest & Pre-Operation](#) earlier in this section.

Scale Adjustments

The scale allows two user adjustments: zeroing and calibration. The first, and most frequently performed, is 'zeroing' the scale. This operation resets the scale's "at rest" reading to zero which must be within the range of - 0.2 pounds (- 1.25 grams) to +0.6 pounds (0.27kg) since the last calibration. While the 'at rest' reading remains within the zero range, the scale will automatically adjust itself to true zero. The scale also automatically zeros itself on power-up if the weight present on the scale is within these defined limits.

Zeroing the Scale

The zeroing operation may be performed by checkers and other store personnel. Pressing and releasing the Scale Zero Button should return the scale to Normal Operation. If the zero point moves out of the zero range due to debris accumulation or other causes, pressing the Scale Zero Button will not reset the zero point. In this case the weigh platter must be cleaned, debris chutes cleared of debris or the scale must be recalibrated.

With the scanner/scale powered-up and at operating temperature:

1. Remove everything from the weighing surface of the scanner/scale.
2. Press the Scale Zero Button. (See [Figure 58](#)).
3. The Zero¹ light will turn on and the display will show 0.00 lb (0.000 kg). If it does not, see [Chapter 4, Problem Isolation](#).
4. You have completed the scale zeroing function.

Alternatively, a reset (cycling power to the scanner) may also allow the scale to re-zero.

Calibrating the Scale

The second adjustment, calibration, defines and sets a standard reference weight range against which all product weights are compared. If your scale is set for weighing in pounds, this range is 0 - 30 pounds, and, if your scale is set for weighing in kilograms, the range is 0 - 15 kilograms. The scale must be calibrated upon initial installation, whenever the scale cannot be zeroed, when the scale diagnostics indicate a calibration error, when the weighing measure (pounds or kilograms) is changed, or when the scale module has been replaced.

Normally, once the scale has been calibrated, the calibration must be verified and/or approved by a local regulatory body. In many areas, the scale calibration switch must be sealed before being placed into service. Consult the agency responsible for regulating weighing devices in your area to ensure that you are meeting all legal and regulatory requirements [Chapter 6, "Calibration Procedures"](#), describes the calibration sequence and verification process.

Calibration can only be performed if the tamper seal that secures access to the Calibration Switch is broken and the switch cover is removed. Breaking the seal may *legally* render the scale

1. Zero light operation is configurable.

inoperable until it has been recertified and a new seal attached. Consult your local regulations before removing the calibration seal if you are unsure of the legal requirements. Although the scale will physically continue to weigh products, a broken seal may require recertification by a proper authority as designated by your local laws.

Operational Maintenance

The scanner or scanner/scale will provide dependable service for many years. The following maintenance procedures will keep your scanner or scanner/scale operating at peak performance.

Cleaning the Weigh Platter and Scan Windows. Clean the exterior surfaces of the horizontal and vertical scan windows at least twice daily with a nonabrasive, mild, water-based glass cleaner and paper towels or lint-free cleaning tissues. The textured plastic surfaces and stainless steel can also be cleaned using the same cleaning agents.

Cleaning the Air Gap/Debris Chutes & Drip Rail. Daily, clear the debris chutes between the platter and the outer housing. Most items can be cleared from the debris chutes by carefully running a thin stiff object like a credit card along all sides of the weighing surface. If necessary, remove the platter to clear the debris chutes and drip rail.

Vertical Scan Window Replacement

The two Vertical Scan Windows enclosed in the All Weights™ Platter are replaceable. Follow these instructions to remove and replace a vertical window:

To remove a Vertical Scan Window:

1. Grasp the platter as shown in [Figure 37](#) and gently lift it from the scanner until the edges can be grasped, and then lift straight up. If the top edge of the platter is blocked, you may find it easier to grip the edges of the platter as shown by the arrows.

Figure 37. Platter Removal

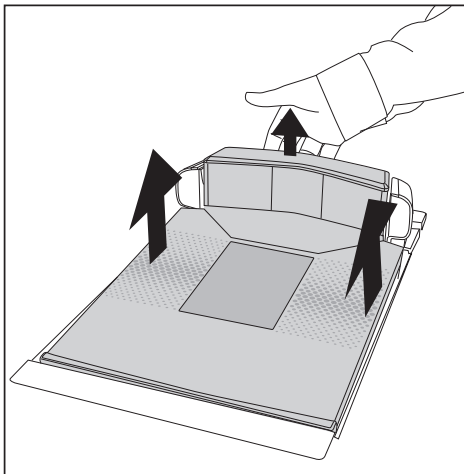

2. The Vertical Scan Windows are held in place by the flat wedge-shaped plastic piece (#2 in [Figure 38](#)) directly in front of them. To remove it, carefully release the six tabs on the underside of the platter as shown in #1 of [Figure 38](#), then carefully turn the platter over and gently lift the plastic piece off of the platter.

3. Either vertical window can be pressed out of its frame as shown in #3 of Figure 38. Carefully dispose of any damaged glass (#4 of Figure 38).

Figure 38. Vertical Scan Window Removal/Replacement

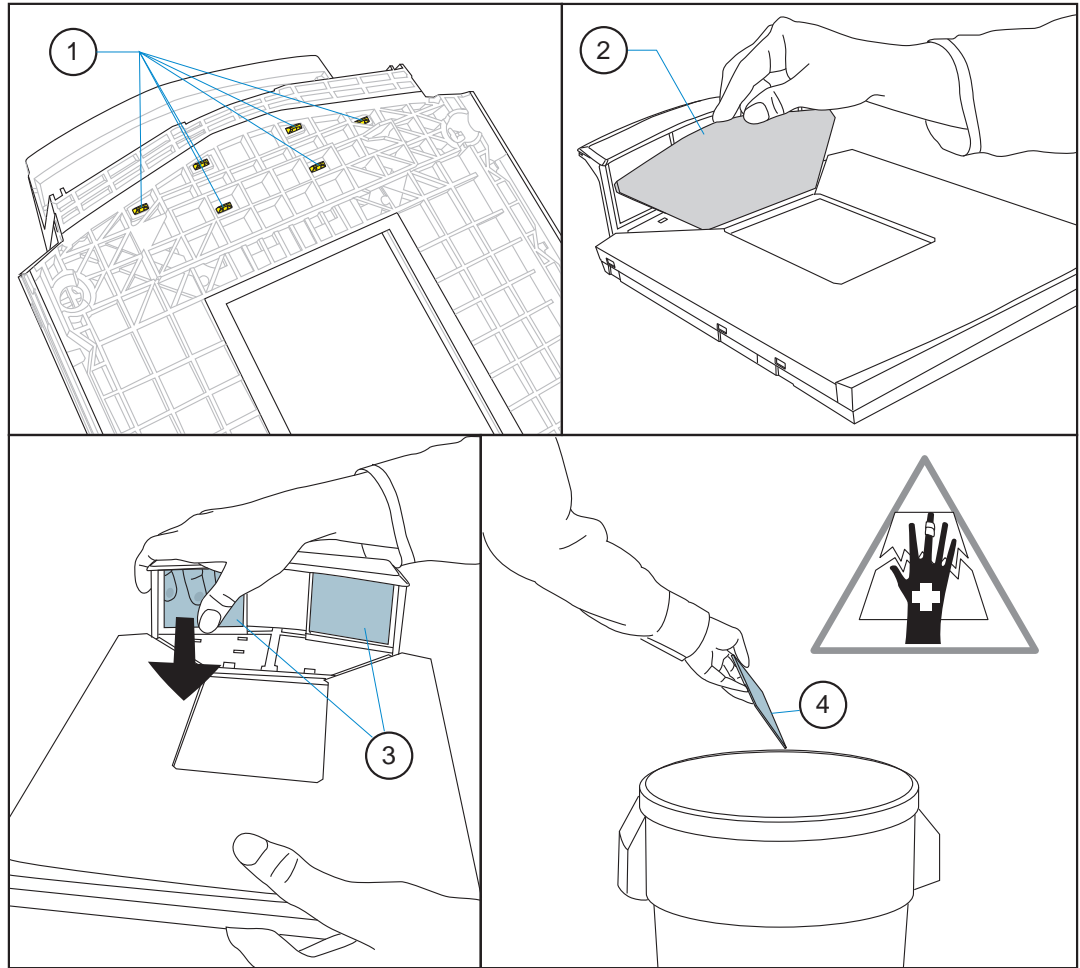

1	Push in to release 6 tabs	3	Press window(s) in or out of the frame
2	Lift off the wedge-shaped plastic piece	4	Carefully dispose of the damaged glass

4. Carefully align the new vertical scan window its window frame. Push in and upwards to seat the window in the frame and secure it in place.
5. Reinstall the wedge-shaped plastic piece (#2 in Figure 38), pushing down gently but firmly over the entire surface to engage all six snaps and three detents along each side where the plastic and stainless steel bezel are joined.
6. Clean both sides of the Vertical Scan Window using a paper towel or lint free cleaning tissues dampened with a mild, water-based glass cleaner. DO NOT use abrasive cleaners or pads.
7. Reinstall the platter. Vertical Scan Window replacement is now complete.

Horizontal Scan Window Replacement (DLC)

Diamond-Like Carbon coated (DLC) horizontal scan windows are replaceable. Use the instructions below to remove and replace the window.



Sapphire glass does not require replacement, so it is permanently fastened in place. Do not attempt to remove Sapphire glass from the platter.

NOTE

1. Remove the All Weighs™ Platter from the scanner as shown in [Figure 37](#).
2. Turn the platter upside down on a clean, dry surface and remove the two screws as shown (#1 in [Figure 39](#)). Retain all screws and nuts for later reinstallation.
3. Lift the edge of the retainer shown (#2 in [Figure 39](#)) and remove it from the assembly.
4. Take note of how the gasket is seated, then gently peel it away from the assembly. Retain the gasket (#3 in [Figure 39](#)) for reinstallation.
5. The window (#4 in [Figure 39](#)) can now be removed. Carefully dispose of any damaged glass.
6. While carefully holding it by its edges, orient the new horizontal window with the words “THIS SIDE UP” facing down (the assembly is upside down at this point), then place the window into position.
7. Fit the gasket into its channel and press around its entire perimeter to ensure it is fully seated. Start by pressing in all four corners first.
8. Secure the retainer using the original two screws.
9. Clean both sides of the new horizontal window using a paper towel or lint free cleaning tissues dampened with a mild, water-based glass cleaner. DO NOT use abrasive cleaners or pads.

Reinstall the platter. Gasketed horizontal window (DLC) replacement is now complete.

Figure 39. Removing/Replacing the Gasketed DLC Window

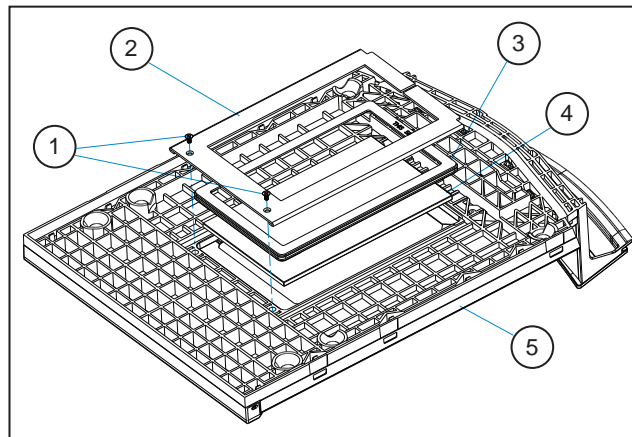

1	Remove 2 screws	4	DLC Window
2	DLC Retainer	5	All Weighs Platter (inverted view)
3	Gasket		

Chapter 4

TDR, Camera and Mobile Commerce

The scanner can optionally include a Top Down Reader (TDR), Camera and/or a Mobile Commerce Reader. These premium features offer state-of-the-art functionality to point of sale transactions, while increasing first pass read rates for item scanning.

Optional TDR Feature

The Top Down Reader adds sixth side scanning to an already extensive scan zone (see [Figure 40a](#)). Items being passed through the zone will be scanned from the top as well as the front, back, two sides and bottom as shown in [Figure 40b](#).

Figure 40. Top Down Reader (TDR)

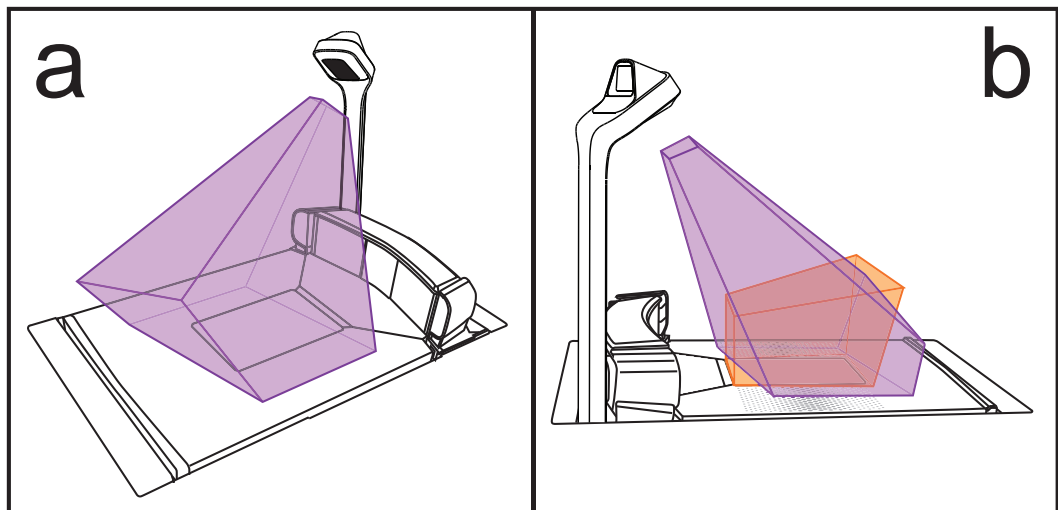

Camera Feature

In addition to scanning bar codes, the TDR can optionally be used to photograph images presented to the down-facing TDR window. The sales associate presses the scanner's Camera button to initiate Camera Mode and take pictures.



The way in which the TDR takes pictures in Camera Mode is a configurable feature. See Chapter 7, Programming for more details.

NOTE

Pictures can be optionally saved to a media card inserted in the scanner's microSD card slot.

Mobile Commerce Reader

The Mobile Commerce Reader allows a customer to present digital coupons or other bar codes from a cell phone or other device for convenient reading during checkout. The Mobile Commerce Reader has different options for how it is enabled for reading items presented by the customer. These are covered in more detail in the programming section, [Top Down Reader \(TDR\) and Mobile Commerce Imaging Features](#), starting on page 101.



Mobile Commerce options are also a configurable feature. See Chapter 7, Programming for more details.

NOTE

Figure 41. Scanning a Bar Code from a Cell Phone



Chapter 5

Problem Isolation

The troubleshooting references provided in this section should be used in the event of a suspected functional problem. This information will assist you in identifying and resolving any problems.

The scanner/scale has a number of features that indicate when a scanner, EAS deactivation system, or scale problem occurs. The unit may:

- emit a series of tones
- light the Health & Status Indicator (FRU status) display
- flash its indicator LEDs
- display error codes on the Remote Display (if installed)

Three error reporting modes are used: Power-Up Selftest, Operational tests and Diagnostic tests. These test sequences are explained on the following pages.

Power-Up Selftest

The Power-up Selftest is a pre-operational series of tests that must be successfully completed before the scanner indicates readiness for operation. This pre-operational period is the time between power-up and normal operation during which the software, firmware and hardware are being tested. These tests ensure that all subsystems are fully functional before turning on. Refer to the [Section 3](#) subsection titled, [Operational Modes](#) for a more detailed description of this and other scanner and scale modes.

Operational Tests

These are the tests that run continually during Normal Operation and Sleep Mode. Firmware checks all subsystems, accessory connections and the POS interface to verify everything is operating normally. If a problem is detected at any time, a long, low tone is sounded, an error code is shown on the Health & Status Indicator, and operation may be halted. If you press the Scanner Control Button at that time, a series of tones will be sounded that matches the error code displayed.

Diagnostic Tests

See [Chapter 2, Diagnostic Modes](#), for details about running diagnostic tests for the scanner and/or scale. If a problem is discovered during diagnostics, the scanner will provide feedback about the source of the problem. The remainder of this section describes these failure indications and includes troubleshooting flowcharts to help isolate the problem.

Diagnostic Procedures

Your Point-Of-Sale (POS) system may contain many components that operate as a system. Since almost all scanner or scale problems are caused by either the scanner, scale, POS terminal or communication links between them, these troubleshooting flowcharts focus on these components. Additionally, the optional Remote Scale Display, AC/DC Power Supply and their cables are potential problems addressed in this section.







The flowcharts provided in this section walk you through a diagnostic process that will isolate the failed component and instruct as to the corrective action required. Since internal scanner and scale components cannot be replaced by an operator or installer, most functional errors will require the assistance of a trained [Technical Support](#) person. However, if the problem is caused by faulty cable, power supply or remote display, you can fix the problem by replacing the defective component and complete the installation.

Error Codes

If an error is detected, the LEDs on the left control panel will perform a “walking pattern” top to bottom indicating a failure. When this occurs, press the Scanner Control Button to display the error code on the Health & Status Indicator (refer to [Figure 42](#)). If it is configured to do so, the scanner will also sound a series of beeps in concert with the LED corresponding to the (FRU) error code. The table below describes what these codes mean and what action should be taken for each.



When troubleshooting, always remember to check all cable connections first before proceeding with other problem isolation steps.

Health & Status Indicator	LED & Beeper	Probable Cause	Corrective Action
 Blinking	Beeper “chirps”	Configuration	No POS interface has been selected (Null interface). See Chapter 7, "Interface Type" to select the required interface using programming bar codes.
	1	Configuration Error	Make sure the correct interface is selected, then scan the factory defaults bar code and reset the unit. Also, see Chapter 7, Programming , for details about configuring the scanner using programming bar codes.
	2	Host Interface	Unplug unit and call technical support personnel.
	3	Main Board	Unplug unit and call technical support personnel.
	4	Imager	Unplug unit and call technical support personnel.
	5	ScaleSentry	See Chapter 7, Programming , for details about configuring the scanner for this optional feature, which may not have been purchased for your scanner.













Health & Status Indicator	LED & Beeper	Probable Cause	Corrective Action
	6	Interface Board	Unplug unit and call technical support personnel.
	7	Scale	See the topic Scale Error Reporting in this section for problem identification and corrective actions.
	8	Remote Display	Connect the Remote Display. If necessary, replace display or cable. Alternatively, you can disable the Remote Display using the programming procedures described in Chapter 7 .
	9	Sensormatic Interface	No EAS communication. Check EAS cable connections and power to the EAS controller. Call technical support personnel.
	10	Control Panel	Call technical support personnel.
		Field Programmable Gate Array (FPGA)	Call technical support personnel.
		Scale Calibration	Proceed to scale calibration procedure.
		Top Down Reader (TDR)	Check TDR cable connections and verify TDR configuration settings in Chapter 7, Programming . Call technical support personnel.
		Image Processing Engine (IPE)	Try resetting the scanner. If the problem persists, unplug the unit and call technical support personnel.
		Scale Interface Mismatch	Unplug unit and call technical support personnel.
		Mobile Commerce Reader	Check TDR cable connections and verify Mobile Commerce configuration settings in Chapter 7, Programming . Call technical support personnel.
 Decimal Point		3.3 V Present	If not lit, call technical support personnel.
N/A	11	Hardware ID	Call technical support personnel.
N/A	12	Model ID	Call technical support personnel.
N/A	13	CPLD ID	Call technical support personnel.

Figure 42. Health & Status Indicator

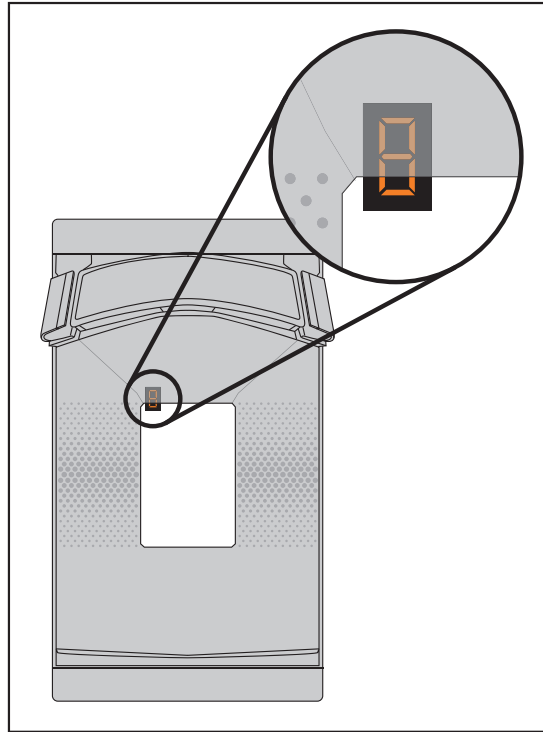
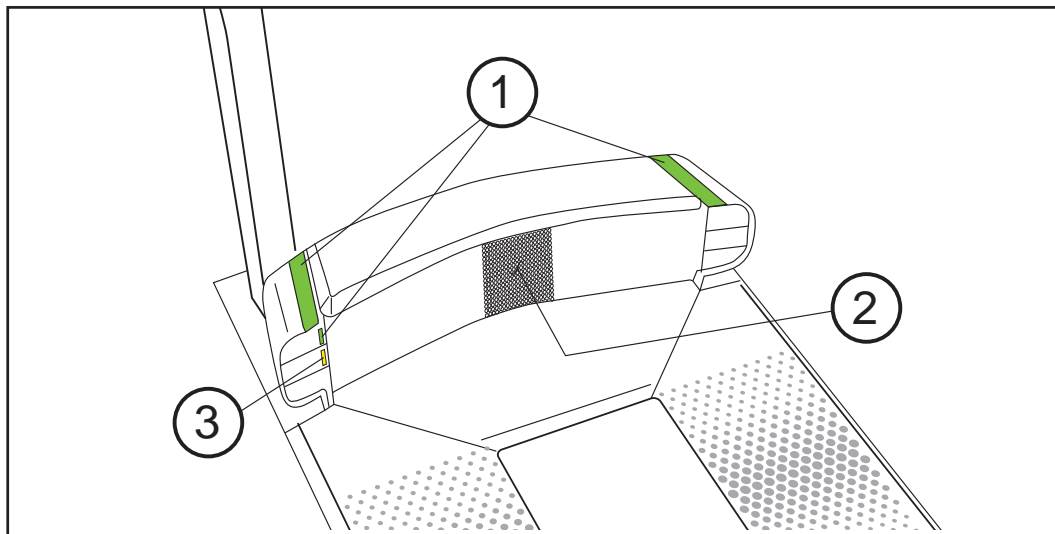

Figure 43. LED and Beeper



1	LED "Good Read" Indicator Bars/LEDs	3	Yellow Scale Status LED Indicator
2	Speaker ("Beeper")		

Scale Error Reporting

Scale diagnostics uses the optional Remote Scale Display and the Zero Status lamp to communicate specific scale failures.



This does not apply to Adaptive Scale models.

The following chart shows the Remote Display messages, the Scale Status lamp indication, the problem that the scale is experiencing and what action should be taken. When troubleshooting, always remember to check all cable connections first before proceeding with other problem isolation steps.

Remote Display	Scale Status LED ^a	Problem Description	Action Required
E_1	Flash, pause, 1 blink, long pause, repeat sequence.	Too much motion at power-up.	Check for stable installation. Change scale motion filter using the labels found in the Programming section; restart. If the problem persists, the scale may require calibration.
E__2	Flash, pause, 2 blinks, long pause, repeat sequence.	Calibration lost.	Call technical support personnel. Re-calibrate; restart; recertify (if required).
E__3	Flash, pause, 3 blinks, long pause, repeat sequence.	Scale communication lost. Internal scanner/ scale problem.	Call technical support personnel; report error.
E__4	Flash, pause, 4 blinks, long pause, repeat sequence.	Scale module failure.	Call technical support personnel; report error.
E__5	Flash, pause, 5 blinks, long pause, repeat sequence.	Internal software fault.	Call technical support personnel; report error.
Other Scale Reporting			
- 0 -	Off	Cannot zero at power-up or weight remains on scale for more than 4 minutes or weight has not returned to zero between POS weight requests ^b .	<ul style="list-style-type: none"> - Check debris chutes. - Verify that the weigh platter moves freely. - Remove item(s) from scale - Press Scale Zero Button - for more information. - If the scale still fails to zero, recalibrate the scale.

a. See [Figure 43](#), item #3.

b. This is a configurable feature.

Flowcharts

The problem isolation flowcharts on the following pages allow you to identify and troubleshoot problems with your system.

Figure 44. Problem Isolation: Start

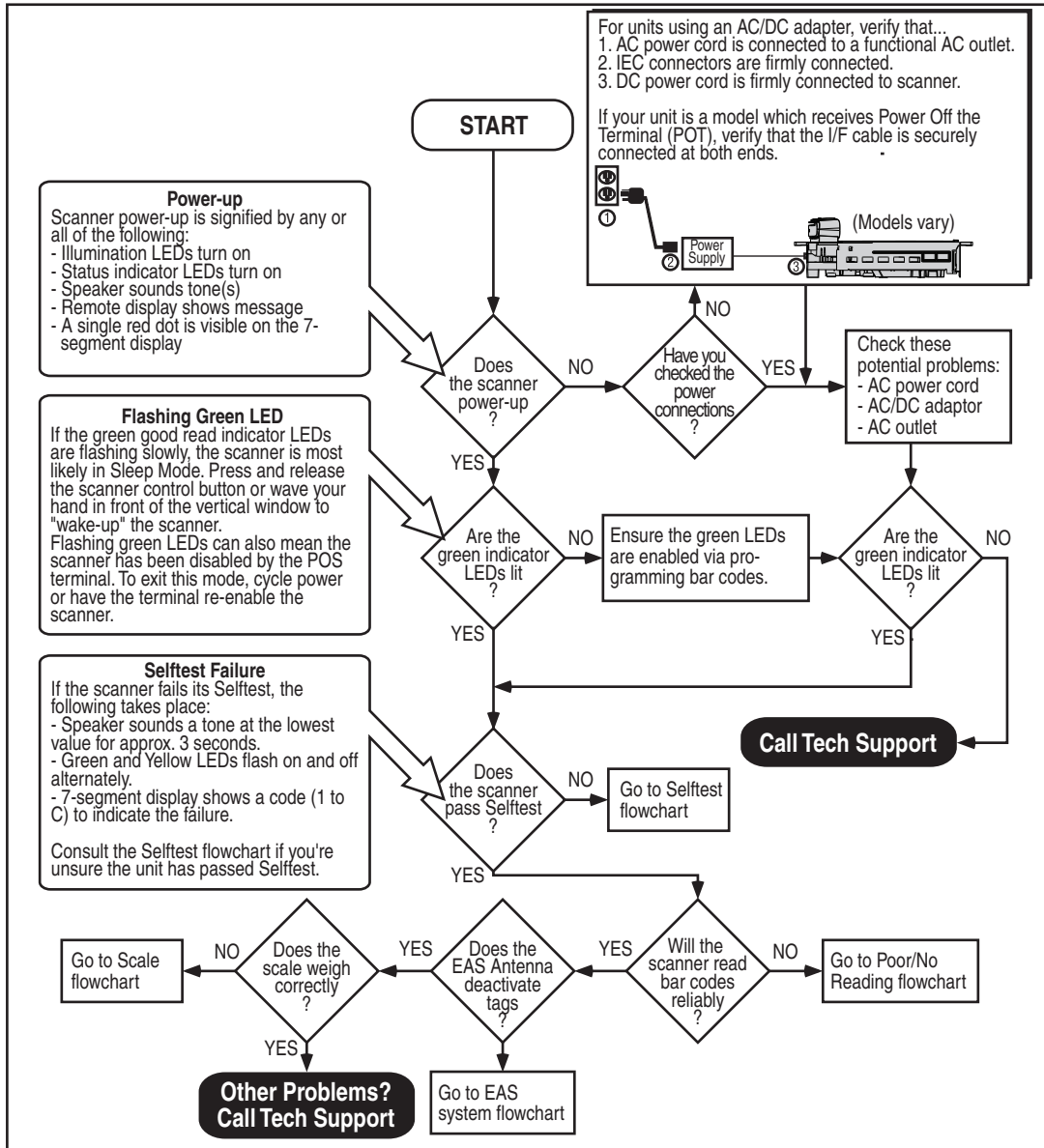

Figure 45. Problem Isolation: Selftest

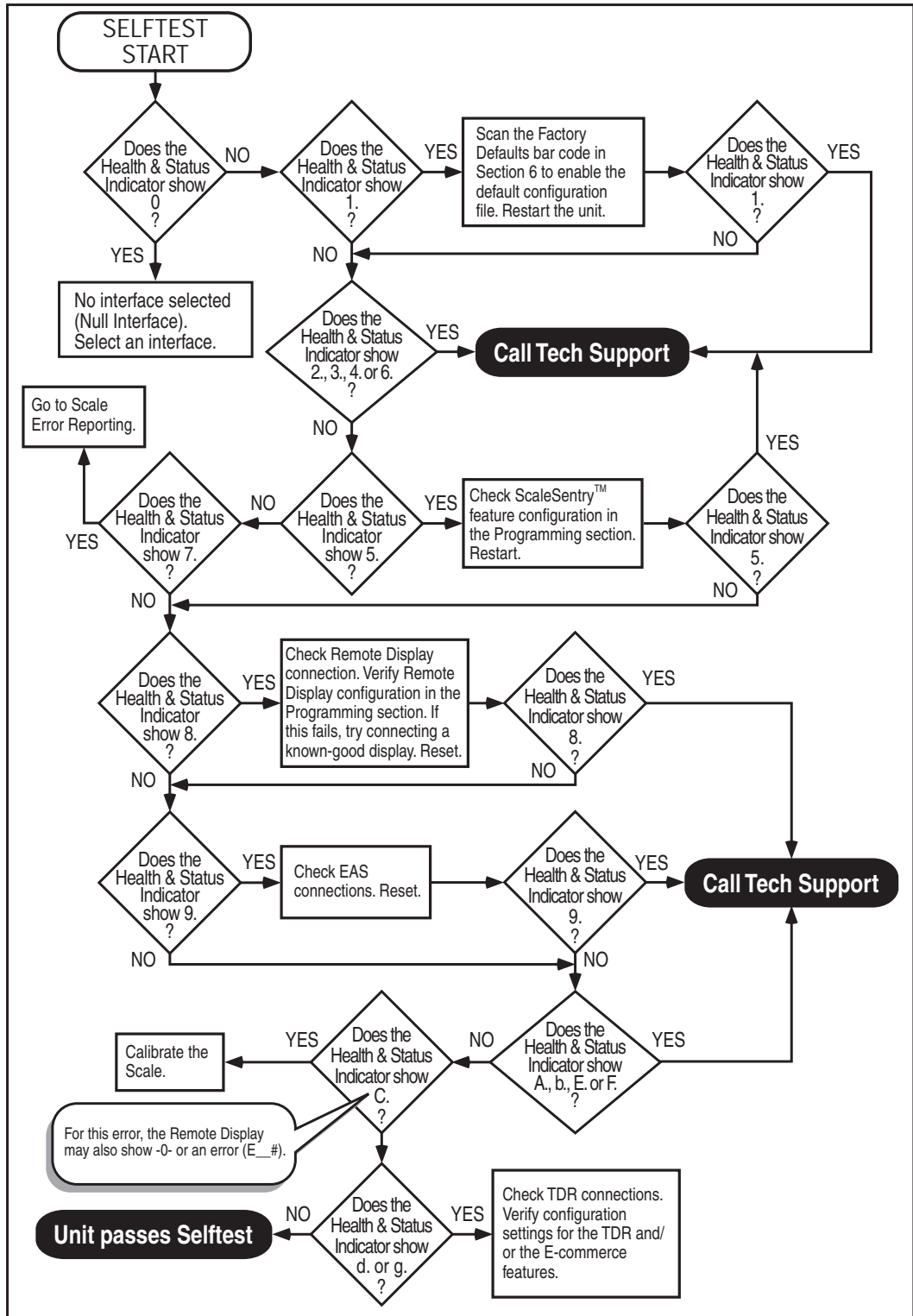

Figure 46. Problem Isolation: Poor/No Reading

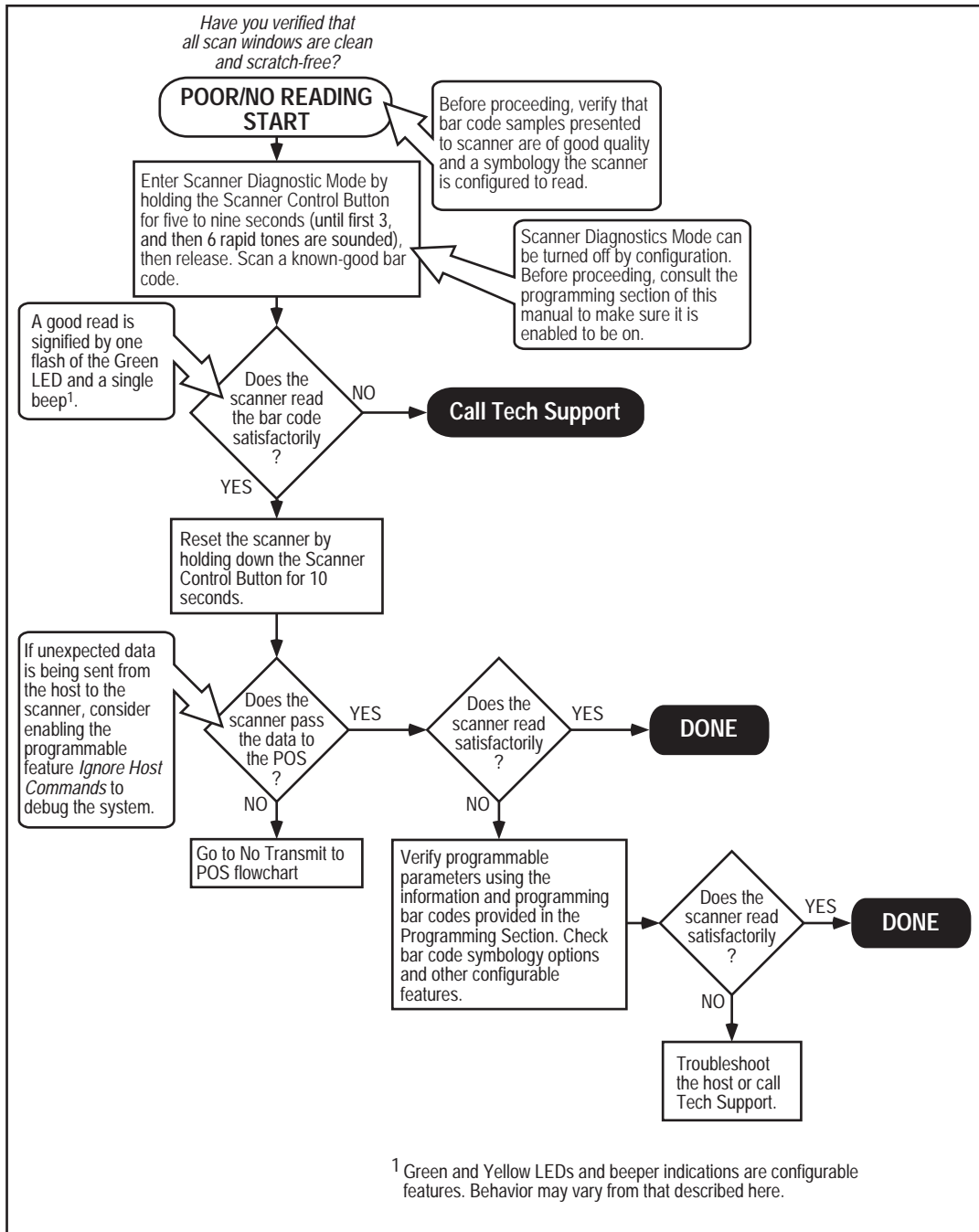

Figure 47. Problem Isolation: No Transmit to POS

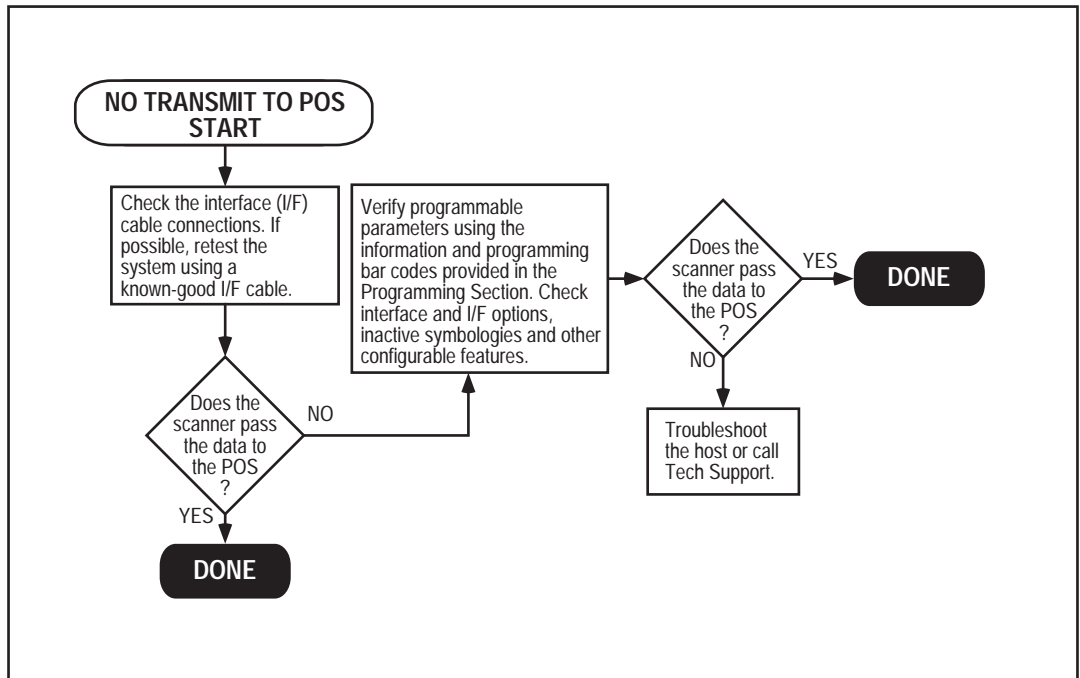

Figure 48. Problem Isolation: Scale

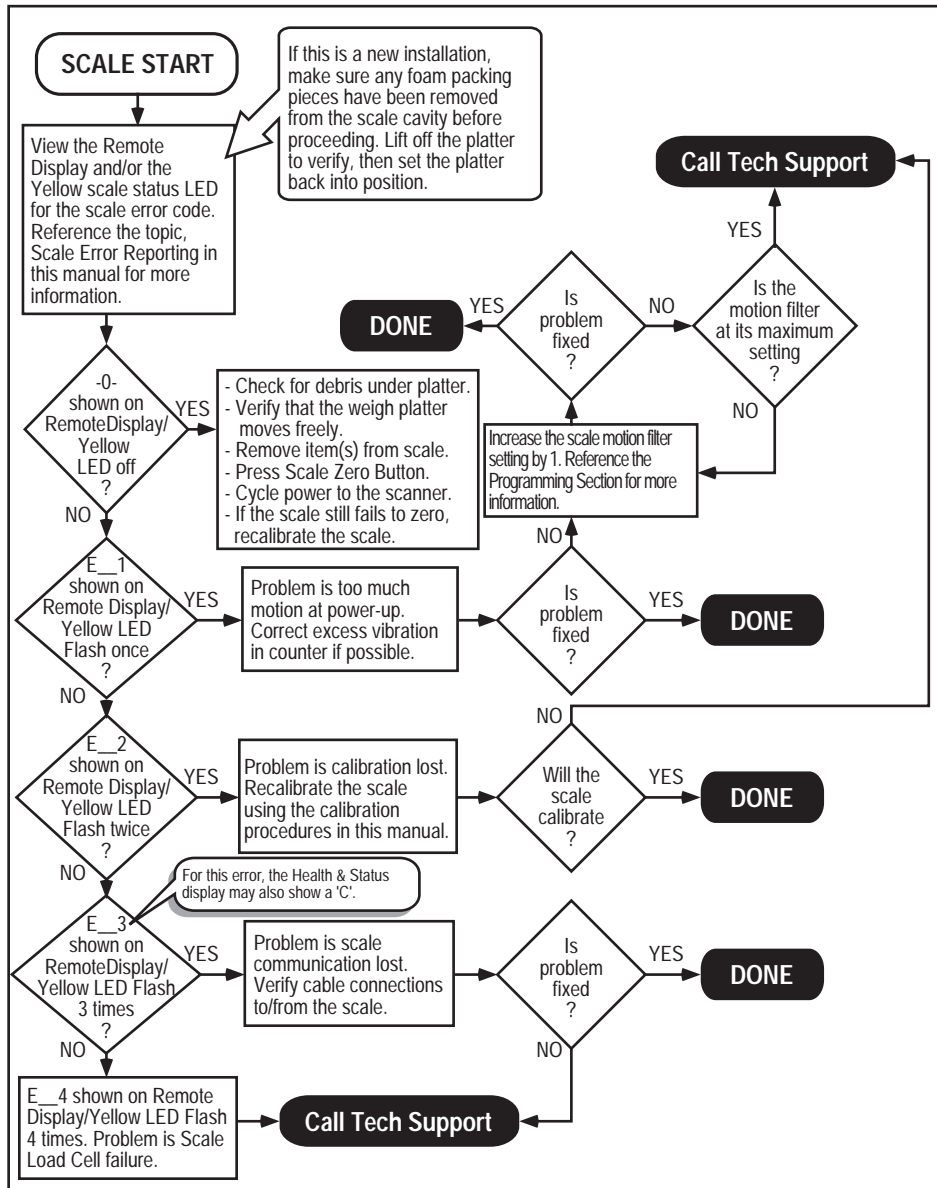

Figure 49. Problem Isolation: Remote Display

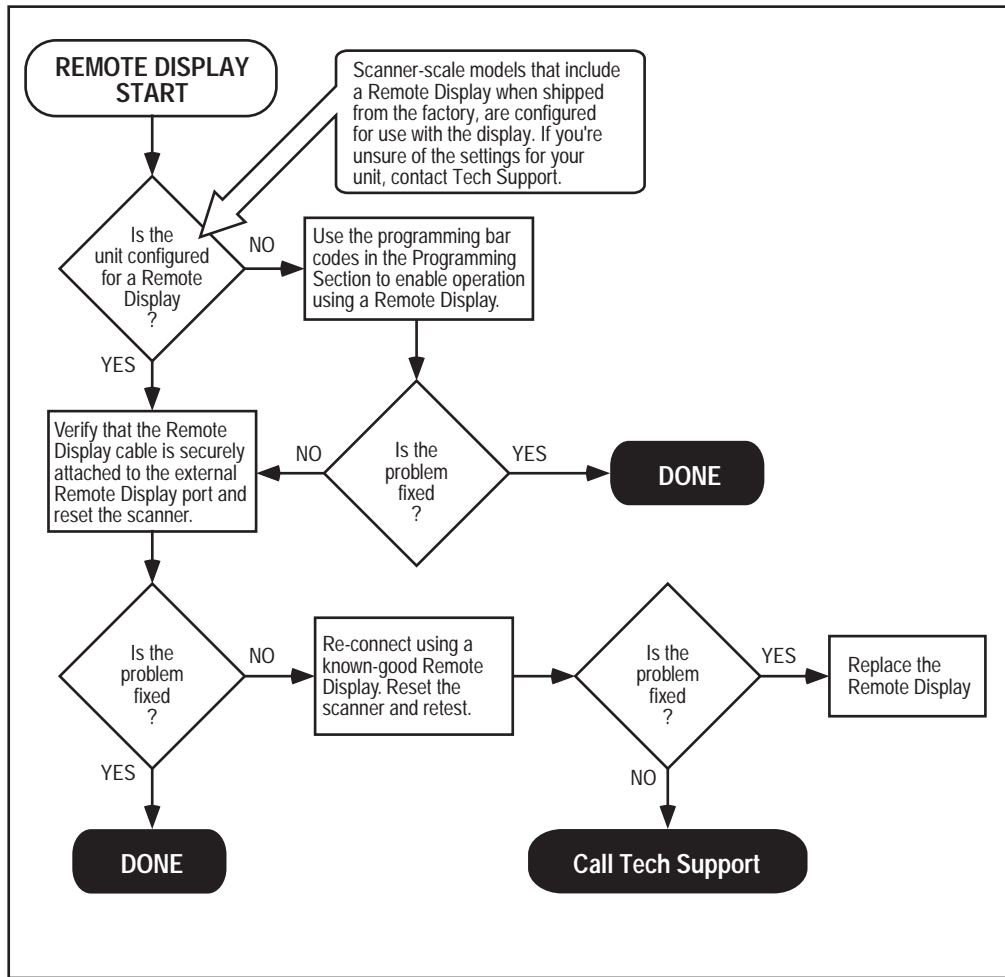
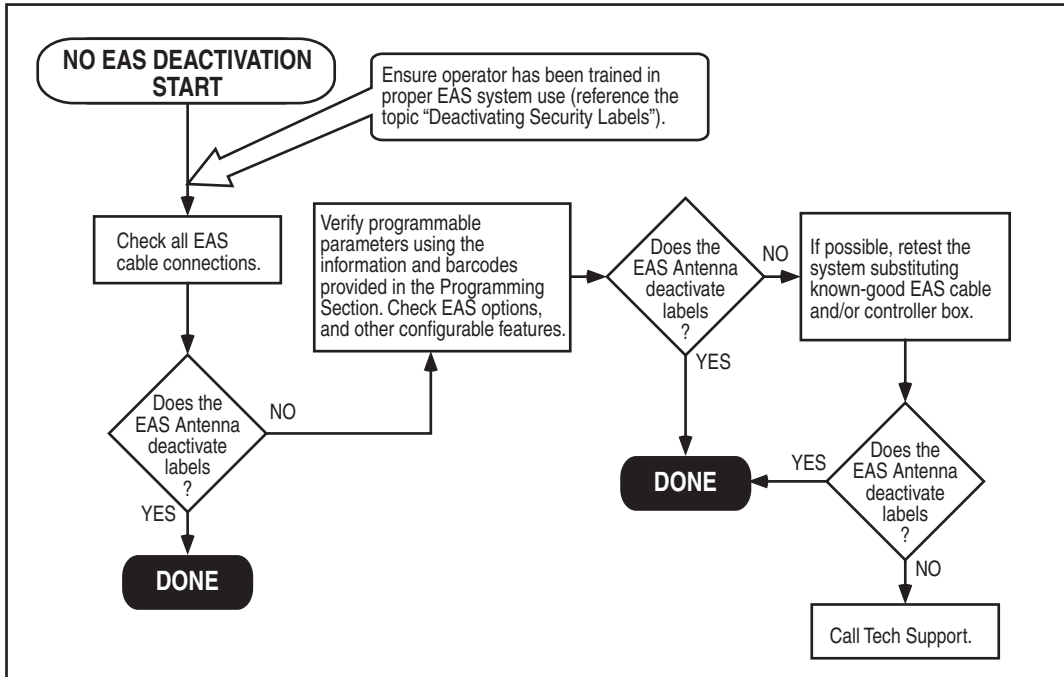
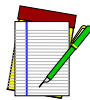

Figure 50. Problem Isolation: EAS System



Chapter 6

Calibration Procedures



NOTE

This section applies to scanner/scale models with single or dual interval. Make sure to follow the proper associated procedure for each of these options. Procedures specific to **single** interval units is highlighted in a **salmon color**. Procedures specific to **dual** interval units is highlighted in a **teal color**.

These procedures are not applicable for adaptive scale models. Consult your adaptive scale documentation or the adaptive scale manufacturer for more information.

A number of situations require the scale to be calibrated. They are:

- at initial installation of the scanner/scale
- if the scale cannot be rezeroed
- when changing the weight measure from pounds to kilograms or vice-versa
- if diagnostics indicate a calibration error
- when removing/replacing any scale assembly or the Main Board
- when required by local regulations

Follow the procedures on the following pages to ensure that the scanner/scale will meet Weights and Measurement requirements.

LEGAL NOTE

Certification of the scanner/scale's weighing apparatus is subject to Federal, State and Local Weights and Measures statutes and is restricted to authorized government agencies and/or duly registered agents thereof. Anytime a scale is calibrated, it should be properly sealed with a lead and wire or paper seal before being placed into service.

It is your responsibility to check with the appropriate authorities in your area to ensure compliance with pertinent regulations before removing any official seals or placing a newly calibrated scanner/scale into service.



CAUTION

DO NOT apply a calibration seal to include the EAS antenna (if one is present). Reference [Figure 52](#). If the antenna must be removed for other reasons, this would unnecessarily cause the scale to require recalibration.

Description of Calibration Sequence

The Calibration Sequence sets the scale to an accurate reference point for weighing. This process involves the use of a Field Standard Weight Set (31.5-pounds) for calibration in pounds, (18.5-kilograms) for Metric calibration. Once calibration has been successfully completed, the scanner/scale uses the certified weight as a reference for subsequent weighing activities.

These verification procedures follow the *U.S. National Institute of Standards and Technology 44 Handbook* guidelines for bench/counter scale installations.

If any of these tests fail to meet the required weight indications, you must calibrate the scanner/scale. Refer to the calibration procedures in this section for the proper procedures.

You may be required by state and/or local regulations to have procedures other than these performed by a certified technician or verification official.

Access to the calibration switch should be restricted with a paper or a wire and lead seal after the calibration has been performed if required by your local regulatory agency.



The Calibration Sequence must be performed without removing the scanner/scale from its installed position.

NOTE

The following tools and supplies will be required to perform the calibration process:

- 31.5 pound Field Standard Weight Set¹.
(English calibration only).
- 18.5 kilogram Field Standard Weight Set².
(Metric calibration only).
- Lead wire or paper seal (as required by law).

Motion Test

This test verifies that the scale will not 'zero' when the weighing surface of the scanner/scale is in motion.

1. Verify that the Zero lamp is On and the Remote Display reads 0.00 pounds, 0.000 pounds or 0.000 kilograms.
2. Press lightly on the weigh platter of the scanner/scale with one hand and at the same time press and release the Zero switch on the operator's panel. The Zero lamp should turn Off and the Remote Display should not display 0.00 pounds, 0.000 pounds or 0.000 kilograms.
3. Remove your hand from the weighing platform and verify that the Zero lamp is On and the Remote Display reads 0.00 pounds, 0.000 pounds or 0.000 kilograms.

1. NOTE: Throughout the calibration procedures, specified weights may be achieved by using a combination of weight from this set. e.g. 20 lbs may be made up of one 10.00 lb. weight and two 5.00 lb. weights.

2. NOTE: Throughout the calibration procedures, specified weights may be achieved by using a combination of weights from this set. e.g. 10 kgs. may be made up of one 5.00 kg. and five 1.00 kg. weights.

Automatic Zero Setting Test

This test verifies that the scanner/scale automatic zero setting mechanism is operating correctly.

SINGLE INTERVAL	DUAL INTERVAL
Place 0.006 pounds (3 grams for metric) on the center of the weighing platform. The entire weight must be placed on the weighing platform at once for this test to be valid. The Yellow LED should go Off and the Remote Display should read 0.01 pounds (0.005 kilograms).	Place 0.0035 pounds (1.6 grams for metric) on the center of the weighing platform. The entire weight must be placed on the weighing platform at once for this test to be valid. The Zero lamp should go Off and the Remote Display should read 0.005 pounds (0.002 kilograms).

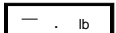

NOTE

The scanner/scale has an adaptive zero capture mechanism that re-zeros the scale over time if there is a slow change in the zero level; thus, if all the weight is not placed on the weighing surface at one time, the Zero lamp will remain On and the Remote Display will read 0.00 pounds or 0.000 pounds (0.000 kilograms). When the weight is removed, the Zero lamp will turn off and the display will show a minus sign . Press the Zero switch to rezero the scale.

Preparing the Scanner/Scale for Calibration

1. Assure that the scanner/scale is stable.
2. Power-up the scanner/scale.
3. Allow the unit to reach temperature equilibrium for at least one hour. If the scanner/scale is already at room temperature, allow at least 15 minutes to acclimate.
4. Remove all weight from the weighing surface and ensure that there are no obstructions in the debris chutes of the scanner/scale.



NOTE

Do not pay attention to any message on the POS display.

Calibrating the Scale (Pounds & Kilograms)

1. Before proceeding, ensure that the scanner/scale has been prepared for this process by performing the preceding steps titled, [Preparing the Scanner/Scale for Calibration](#)
2. Verify that there are no obstructions under the weigh platter. Remove the weigh platter (L-Platter) and make sure that there are no obstructions in the debris chutes (see [Figure 13](#)).
3. If one is present, cut and remove the seal securing the calibration switch access cover. The seal may not be present if this is the initial installation of the scanner/scale.
4. Slide the cover to reveal the switch as shown in [Figure 51](#).
5. Use a long, blunt object, such as the eraser end of a pencil to press and release the Calibration Switch and place the scanner/scale in Calibration Mode (see [Figure 51c](#)). The scanner/scale will sound a tone indicating that it is in Calibration Mode. The Scale Status (yellow LED) will flash, indicating the scale is in Calibration Mode. If one is present, the Remote Display will show the message “ESCL” (empty scale).
6. Reinstall the weigh platter.
7. Press the Scale Zero Button. The Scale Status (yellow LED) will go out for approximately 10 seconds (or less) and the Remote Display (if present) will alternately display ---- and ____ until the scale is ready to proceed.
8. When the scale is ready, the Scale Status (yellow LED) begins blinking again, and the Remote Display (if present) will show the message “Ad20 (add twenty pounds)” or “Ad10 (add ten kilograms).” The scanner/scale will also sound one tone if the scale is weighing in kilograms or two tones for pounds if you don’t have a Remote Display.
9. Place the correct weight (twenty pounds for calibration in pounds, or ten kilograms for metric calibration) from the Field Standard Weight set, onto the center of the weighing area. Press the Scale Zero Button again.
10. The Scale Status LED extinguishes for approximately 10 seconds and the Remote Display (if present) alternately displays ---- and ____ until the scale is ready to proceed.
11. If the calibration was successful, the speaker sounds a single tone, the Scale Status LED begins blinking again, and “End-” appears in the Remote Display (if one is present).
12. If the calibration was not successful, the speaker sounds five tones indicating a scale failure, and the Scale Status LED will blink twice, strobe (fast blinks), and then continually repeat this sequence until reset. Remove all weight from the Weigh Platter, and repeat the procedure starting with step 8.
13. Press the Scale Zero Button again to permanently store the calibration data and exit Calibration Mode. You have completed the calibration of the scale. The unit’s calibration must now be verified as required by state and/or local weights and measures regulations. The verification procedure must be performed to assure that a scale will pass Weights and Measures requirements before it is placed into commercial/retail service.

You have completed the scale calibration procedure. Before replacing the Calibration Switch Cover and sealing the scale, you must now continue with the calibration verification tests to complete the scale's calibration. If you are weighing in pounds, continue with the following procedures to verify that the scale was successfully calibrated and that it weighs properly. If you are weighing in kilograms, turn to the instructions titled, "Calibration Verification (Kilograms)" on page 85.

Figure 51. Calibration Cover and Switch Location

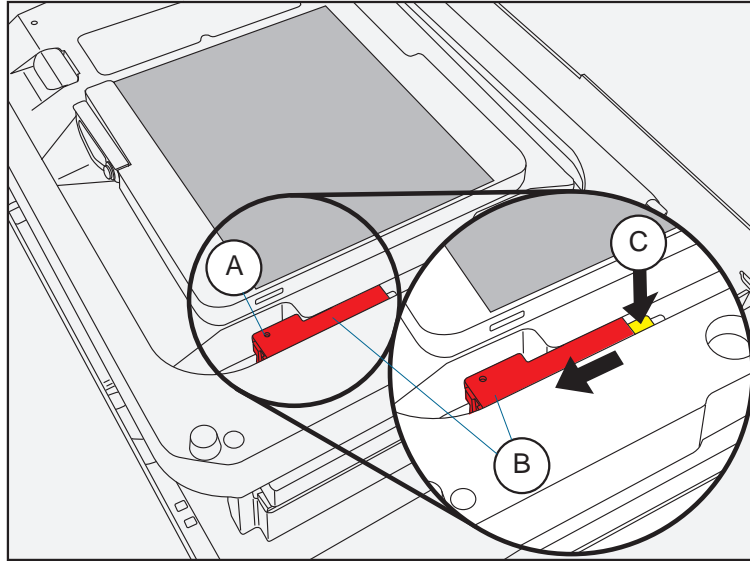

A	Calibration Seal Location	C	Calibration Switch Opening. Use a long, blunt object to reach in and press the Calibration Switch.
B	Calibration Access Cover		



If an EAS antenna is present, it must be lifted in order to access the calibration switch. See Figure 52.

NOTE

Figure 52. If one is present, move EAS antenna to access the Calibration Switch

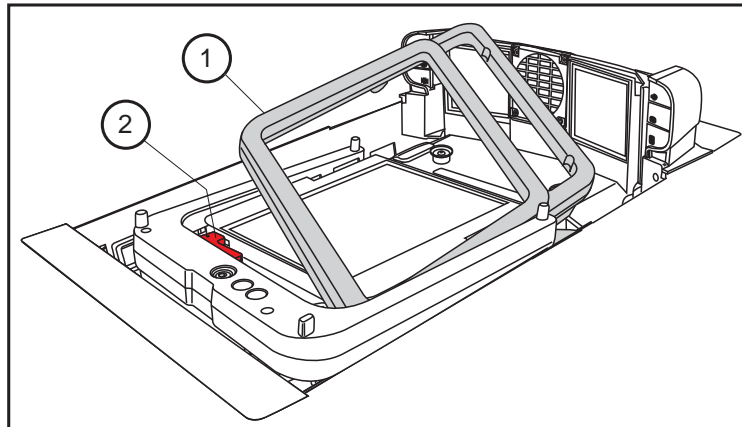

1	EAS Antenna	2	Calibration Switch Cover
---	-------------	---	--------------------------

Calibration Verification (Pounds)

Once you have completed the calibration sequence, you may be required to perform these step-by-step verification procedures. These procedures follow the *National Institute of Standards and Technology Handbook-44* guidelines for grocery scale installations. You may be required by state or local law to have these procedures performed by a certified technician or verified by a proper official.

These calibration verification procedures cover five (5) different tests:

- Increasing-Load Test
- Shift Test
- Blanking Test
- Decreasing-Load Test
- Return to Zero Test



If the scale fails any of the following tests, go to Section 4, Problem Isolation, of this manual and follow the troubleshooting procedures for SCALE FAILURE.

NOTE

Increasing-Load Test (Phase 1)

This test checks Scale operation with two, four and six pound weights.

SINGLE INTERVAL	DUAL INTERVAL
This test checks Scale operation with five, ten and fifteen pound weights.	This test checks Scale operation with two, four and six pound weights.
1. Check that the display reads 0.00 lb. when at rest with nothing on the weighing surface. (The Zero Status LED is steadily lit).	1. Check that the display reads 0.00 lb. when at rest with nothing on the weighing surface. (The Zero Status LED is on steady).
2. Place a five-pound weight on the center of the weighing surface and check that the display reads 5.00 lb.	2. Place a two-pound weight on the center of the weighing surface. Verify that the Remote Display reads 2.00 lb.
3. Place an additional five pounds on the center of the weighing surface and check that the display reads between 9.99 and 10.01 lb.	3. Place an additional two pounds (four pounds total) on the center of the weighing surface. Verify that the Remote Display reads between 3.995 and 4.005 lb.
4. Place an additional five pounds on the center of the weighing surface and check that the display reads between 14.99 and 15.01. Remove the weights and verify that the display reads 0.00.	4. Place an additional two pounds (six pounds total) on the center of the weighing surface. Verify that the Remote Display reads between 5.995 and 6.005. Remove the weights and verify that the display reads 0.00.
5. You have completed the Increasing-Load Test (Phase 1).	5. You have completed the Increasing-Load Test (Phase 1).

Shift Test (6 Pounds Dual Interval ONLY)

The Shift Test checks to ensure that items placed anywhere on the weighing surface of the scanner/scale are weighed properly. Refer to [Figure 53](#) when performing this test.

DUAL INTERVAL	
1.	Place and remove, in succession, a six-pound load on the center of each of the four quadrants: 1, 2, 3, and 4, (as shown in Figure 53) of the scanner/scale's weigh platter. Verify that a reading of between 5.995 and 6.005 lb. registers, under load, in each quadrant tested. Check that the display returns to 0.00 between each load.
2.	After verifying the accuracy of each quadrant of the weighing surface, remove all weight from the scale. This completes the 6 pound Shift Test.

Figure 53. Shift Test

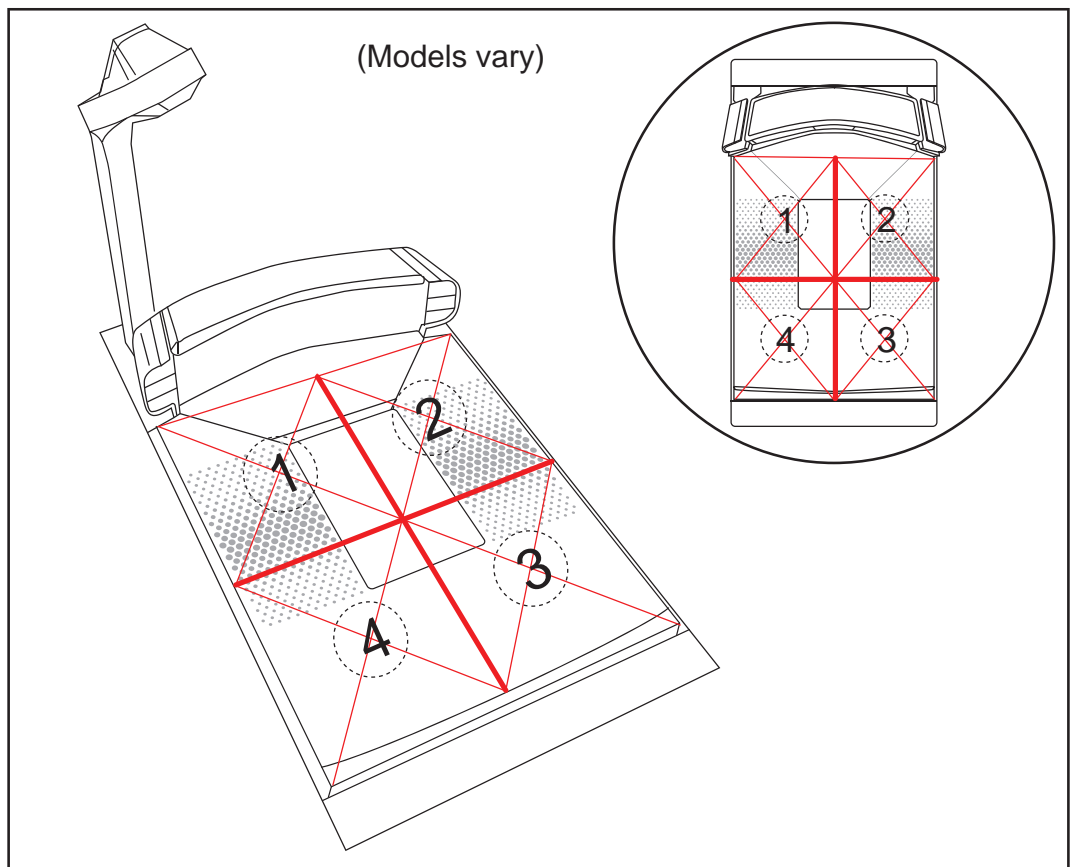

Increasing- Load Test (Phase 2 Dual Interval)



NOTE

The upper limit of the scale is configurable according to the POS interface type and may not necessarily be set at 30 pounds, which is the standard setting. For this test, continue to place weights in two pound increments only up to the upper weight limit set for your scale.

DUAL INTERVAL	
After completing the Shift Test, you must complete the Increasing Load Test using 8.0, 10.0 and 12.0 pounds of weight.	
1.	With the scale starting at zero, place 8.0 pounds in the center of the weighing surface and check that the display reads between 7.995 and 8.005 lb.
2.	Place an additional two pounds (10 pounds total) in the center of the weighing surface. Check that the display reads between 9.995 and 10.005 lb.
3.	Place an additional two pounds in the center of the weighing surface increasing the load to 12.0 pounds and check that the display reads between 11.995 and 12.005 lb.
4.	Place an additional five pounds (fifteen pounds total) on the center of the weighing surface. Verify that the Remote Display reads between 14.995 and 15.01. Remove the weights and verify that the display reads 0.00.
5.	You have completed the Increasing-Load Test (Phase 2).

Shift Test (10 Pounds)

The Shift Test checks to ensure that items placed anywhere on the weighing surface of the scanner/scale are weighed properly. Refer to [Figure 53](#) when performing this test.

SINGLE INTERVAL	DUAL INTERVAL
1. Place and remove in succession, a ten-pound load on the center of each of the four quadrants (1, 2, 3, and 4 in Figure 53) of the scanner/scale’s weigh platter. Verify that a reading of between 9.99 and 10.01 lb registers under load and that the display returns to 0.00 between each load.	1. Place and remove, in succession, a ten-pound load on the center of each of the four quadrants: 1, 2, 3, and 4, (as shown in Figure 53) of the scanner/scale’s weigh platter. Verify that a reading of between 9.99 and 10.01 lb. registers, under load, in each quadrant tested. Check that the display returns to 0.00 between each load.
2. After verifying the accuracy of each quadrant of the weighing surface, remove all weight from the scale. You have completed the Shift Test.	2. After verifying the accuracy of each quadrant of the weighing surface, remove all weight from the scale. This completes the Shift Test.

Increasing- Load Test (Single Interval Phase 2) (Dual Interval Phase 3)

After completing the Shift Test, you must complete the Increasing Load Test using 20.0, 25.0 and 30.0 pounds of weight.



The upper limit of the scale is configurable according to the POS interface type and may not necessarily be set at 30 pounds, which is the standard setting. For this test, continue to place weights in five pound increments only up to the upper weight limit set for your scale.

NOTE

SINGLE INTERVAL	DUAL INTERVAL
After completing the Shift Test, you must complete the Increasing Load Test using 20.0, 25.0 and 30.0 pounds of weight.	After completing the Shift Test, you must complete the Increasing Load Test using 8.0, 10.0 and 12.0 pounds of weight.
1. With the scale starting at zero, place 20.0 pounds in the center of the weighing surface and check that the display reads between 19.99 and 20.01 lb.	1. With the scale starting at zero, place 20.0 pounds in the center of the weighing surface and check that the display reads between 19.99 and 20.01 lb.
2. Place an additional five pounds in the center of the weighing surface, increasing the load to 25.0 pounds and check that the display reads between 24.99 and 25.01 lb.	2. Place an additional five pounds (25 pounds total) in the center of the weighing surface. Check that the display reads between 24.99 and 25.01 lb.
3. Place an additional five pounds in the center of the weighing surface increasing the load to 30.0 pounds and check that the display reads between 29.99 and 30.01 lb.	3. Place an additional five pounds in the center of the weighing surface increasing the load to 30.0 pounds and check that the display reads between 29.99 and 30.01 lb.
4. Remove the weights and verify that the display reads 0.00.	4. Remove the weights and verify that the display reads 0.00.
5. You have completed the Increasing-Load Test (Phase 2)	5. You have completed the Increasing-Load Test (Phase 3).

Blanking Test

This test ensures that the scanner/scale will indicate its weighing capability has been exceeded if a weight greater than 0.05 pounds over its maximum upper weight is placed upon the unit.

1. Place weights that total the upper weight limit plus 0.051 pounds on the scale. For example: If the upper limit is set at 30 pounds, place weights totaling 30.051 pounds on the scale.
2. Verify that the display shows a dash and three hyphens (_ - -). This is the overweight indication.



The scanner/scale may blank (show an underscore and three hyphens) at any weight greater than its upper weight limit, but must blank when the upper weight limit plus 0.051 pounds are set upon the weighing surface.

NOTE

Decreasing-Load Test

This test ensures that the scanner/scale responds properly when a heavy object is followed by a significantly smaller object.



If the upper weight limit for your scale is set to other than 30 pounds, begin by placing weight equaling your upper limit setting.

NOTE

SINGLE INTERVAL	DUAL INTERVAL
1. Place a 30.0-pound load on the scale and verify that the display shows between 29.99 and 30.01 pounds.	1. Place a 30.0-pound load on the scale and verify that the display shows between 29.99 and 30.01 pounds.
2. Remove weights to leave 20 pounds on the scale. Check that the display shows between 19.99 and 20.01.	2. Remove enough weights to leave 20 pounds on the scale. Check that the display shows between 19.99 and 20.01.
3. Remove another 15.0 pounds from the scale and check that the scale reads 5.00 lb.	3. Remove 8.0 pounds and verify the display reads between 11.995 and 12.01 pounds.
4. You have completed the Decreasing Load Test.	4. Remove 4.0 pounds and verify the display reads between 7.995 and 8.005 pounds.
	5. Remove another 6.0 pounds from the scale and check that the scale reads 2 lbs.
	6. You have completed the Decreasing Load Test.

Return to Zero Test

This test ensures that, after all other tests have been completed successfully, the scanner/scale returns to zero. Remove all weights from the scale and verify that the scale reads 0.00 lb.

After completing this test, close the calibration access cover and seal per local Weights and Measures requirements. This final step must agree with the legal requirements of your state or local government.

You have completed the calibration and verification process for weighing in pounds.

If the scanner/scale passes all these tests:

1. Remove the weigh platter, install the calibration switch cover and install a seal (if required).
2. Reinstall the weigh platter.

If the scale fails any of these tests, turn to [Section 4, Problem Isolation](#) and follow the troubleshooting procedures for Scale Failures.

Calibration Verification (Kilograms)

Once you have completed the calibration sequence, you may be required to perform these step-by-step verification procedures. These procedures follow the *National Institute of Standards and Technology Handbook-44* guidelines for grocery scale installations. You may be required by state or local law to have these procedures performed by a certified technician or verified by a proper official.

These calibration verification procedures cover five (5) different tests:

- Increasing-Load Test
- Decreasing-Load Test
- Shift Test
- Return to Zero Text
- Blanking Test



If the scale fails any of these tests, go to the topic [Scale Error Reporting](#) in [Section 4, Problem Isolation](#), of this manual.

NOTE

Increasing-Load Test (Phase 1)

SINGLE INTERVAL	DUAL INTERVAL
This test checks Scale operation for increasing loads from 0.100 kg and 7.50 kg.	This test checks scale operation for increasing loads from 0.050 kg and 3 kg.
1. Check that the display reads 0.000 kg when at rest with nothing on the weighing surface. (The Yellow LED is steadily lit).	1. Check that the display reads 0.000 kg when at rest with nothing on the weighing surface. (The Zero Status LED is on steady).
2. Place a 100 gram weight on the center of the weighing surface and check that the display reads 0.100 kg.	2. Place a 50 gram weight on the center of the weighing surface and check that the Remote Display reads 50 grams.
3. Place an additional 200 grams on the center of the weighing surface and check that the display reads 0.300 kg.	3. Place an additional 100 grams on the center of the weighing surface (.0300 kg. total) and check that the Remote Display reads 150 grams.
4. Place an additional 200 grams on the center of the weighing surface and check that the display reads 0.500 kg.	4. Place an additional 100 grams on the center of the weighing surface and check that the Remote Display reads 250 grams.
5. Place an additional 100 grams on the center of the weighing surface and check that the display reads 0.600 kg.	5. Place an additional 50 grams on the center of the weighing surface and check that the display reads 300 grams.
6. Place an additional 100 grams on the center of the weighing surface and check that the display reads 0.700 kg.	6. Place an additional 50 grams on the center of the weighing surface and check that the display reads 350 grams.
7. Place an additional 100 grams on the center of the weighing surface and check that the display reads 0.800 kg.	7. Place an additional 50 grams on the center of the weighing surface and check that the display reads 400 grams.
8. Place an additional 200 grams on the center of the weighing surface and check that the display reads 1.000 kg.	8. Place an additional 100 grams on the center of the weighing surface and check that the display reads 500 grams.
9. Increase the weight on the scale to 7.50 kg on the center of the weighing surface and check that the display reads between 7.495 and 7.505 kg.	9. Increase the weight on the center of the weighing surface to 2.5 kg and check that the display reads between 2.998 and 3.002 kg.
10. Remove the weights and verify that the display reads 0.000 kg. You have completed the Increasing-Load Test (Phase 1).	10. Remove the weights and verify that the display reads 0.000 kg. You have completed the Increasing-Load Test (Phase 1).

Shift Test Metric (2 Kilogram Dual Interval ONLY)

The Shift Test checks to ensure that items placed anywhere on the weighing surface of the scanner/scale are weighed properly. Refer to [Figure 54](#) when performing this test.

DUAL INTERVAL	
1.	Place and remove, in succession, a 2 kilogram load on the center of each of the four quadrants: 2, 3, 4, and 5, and in the center (1) of the scanner/scale's weighing platform (see Figure 54). Verify that the Remote Display shows a reading of between 1.998 and 2.002 kg for each quadrant/center test. Check that the display returns to 0.000 between each load.
2.	After verifying the accuracy of each quadrant and the center of the weighing surface, remove all weight from the scale. This completes the Shift Test Metric (2 Kilogram).

Figure 54. Metric Shift Test

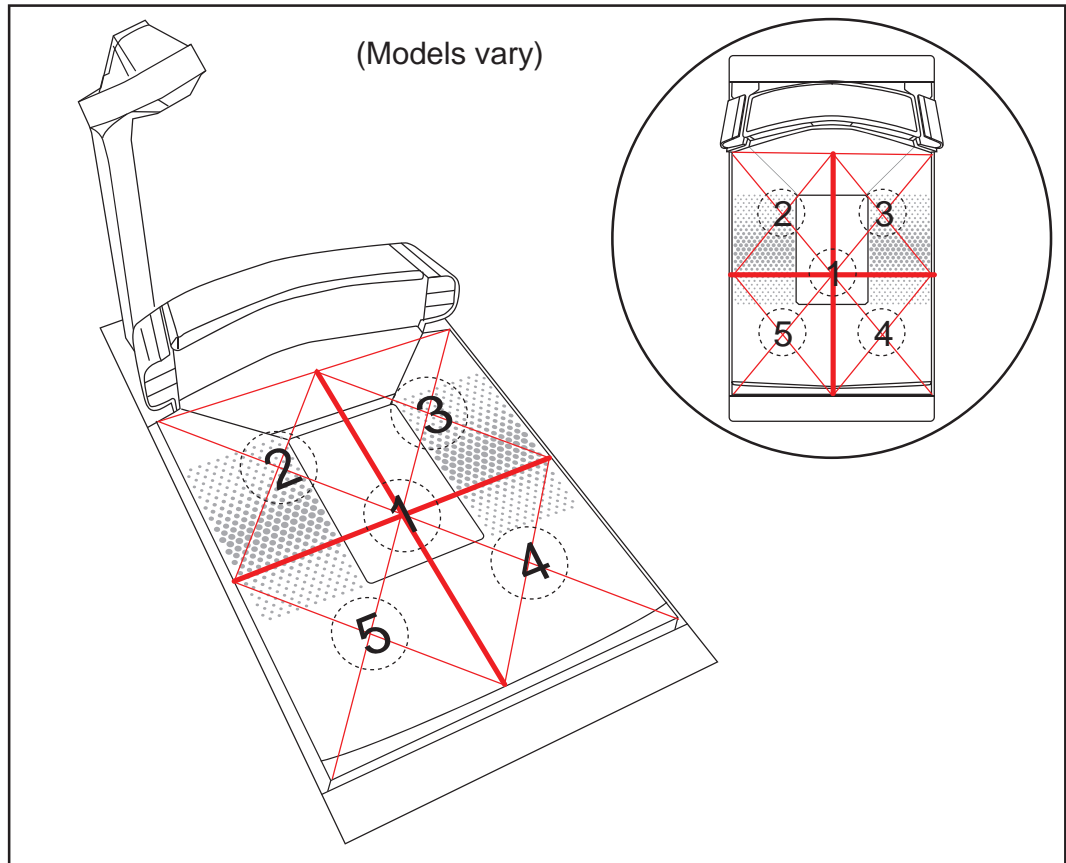

Increasing Load Test (Phase 2 Dual Interval ONLY)

After completing the Shift Test, you must complete the Increasing Load Test using 4, 5 and 6 kilograms of weight.



NOTE

The upper limit of the scale is configurable according to POS interface type and may not necessarily be set at 15 kilograms, which is the standard setting. For this test, continue to place weights in 1 kilogram increments only to the upper weight limit set for your scale.

DUAL INTERVAL	
1.	Place 4 kilograms in the center of the weighing surface and check that the Remote Display reads between 3.998 kg and 4.002 kg.
2.	Place an additional 1 kilogram in the center of the weighing surface and check that the display reads between 4.998 kg and 5.002 kg.
3.	Place an additional 1 kilogram in the center of the weighing surface and check that the display reads between 5.998 kg and 6.005 kg.
4.	Increase the weight on the center of the weighing surface to 7.50 kg and check that the display reads between 7.495 and 7.505 kg.
5.	Remove the weights and verify that the display reads 0.000 kg. You have completed the Increasing-Load Test.

Shift Test — Metric (5 Kilograms)

The Shift Test checks to ensure that items placed anywhere on the weighing surface of the scanner/scale are weighed properly. Refer to [Figure 54](#) when performing this test.

SINGLE INTERVAL	DUAL INTERVAL
1. Place and remove in succession, a 5.0 kilogram load on the center of each of the four quadrants (2, 3, 4, and 5 in Figure 54) and in the center (1) of the scanner/scale's weighing platform. Verify that the display shows a reading of between 4.995 and 5.005 kg for each quadrant/center test and that the display returns to 0.000 between each load.	1. Place and remove, in succession, a 5.0 kilogram load on the center of each of the four quadrants: 2, 3, 4, and 5, and in the center (1) of the scanner/scale's weighing platform (see Figure 54). Verify that the Remote Display shows a reading of between 4.998 and 5.002 kg for each quadrant/center test. Check that the display returns to 0.000 between each load.
2. After verifying the accuracy of each quadrant and the center of the weighing surface, remove all weight from the scale. This completes the Shift Test — Metric (5 Kilograms).	2. After verifying the accuracy of each quadrant and the center of the weighing surface, remove all weight from the scale. This completes the Shift Test — Metric (5 Kilograms).

Increasing- Load Test (Single Interval Phase 2) (Dual Interval Phase 3)



The upper limit of the scale is configurable according to POS interface type and may not necessarily be set at 15 kilograms, which is the standard setting. For this test, continue to place weights in 2.50 kilograms increments only to the upper weight limit set for your scale.

NOTE

SINGLE INTERVAL	DUAL INTERVAL
After completing the Shift Test, you must complete the Increasing Load Test using 10.00, 12.50 and 15 kilograms of weight.	After completing the Shift Test, you must complete the Increasing Load Test using 10.00, 12.50 and 15 kilograms of weight.
1. Place 10.00 kilograms in the center of the weighing surface and check that the display reads between 9.990 kg and 10.010 kg.	1. Place 10.00 kilograms in the center of the weighing surface and check that the Remote Display reads between 9.990 kg and 10.010 kg.
2. Place an additional 2.50 kilograms in the center of the weighing surface and check that the display reads between 12.490 kg and 12.510 kg.	2. Place an additional 2.50 kilograms in the center of the weighing surface and check that the display reads between 12.490 kg and 12.510 kg.
3. Place an additional 2.50 kilograms in the center of the weighing surface and check that the display reads between 14.990 kg and 15.010 kg.	3. Place an additional 2.50 kilograms in the center of the weighing surface and check that the display reads between 14.990 kg and 15.010 kg.
4. Remove the weights and verify that the display reads 0.000 kg.	4. Remove the weights and verify that the display reads 0.000 kg.
5. You have completed Phase 2 of the increasing load test.	5. You have completed Phase 3 of the Increasing Load Test.

Blanking Test

This test ensures that the scanner/scale will indicate its weighing capability has been exceeded if a weight greater than 0.82 kilograms over its maximum upper weight limit is placed upon the scale platter.

1. Place weights that total the upper limit plus 0.82 kilograms on the weigh platter. For example: If the upper limit is set at 15 kilograms, place weight totaling 15.82 kilograms.
2. Verify that the display shows a dash and three hyphens (_---). This is the overweight indication.



The scanner/scale may blank (show an underscore and three hyphens) at any weight greater than its upper limit plus 0.82 kilograms are set upon the weighing surface.

NOTE

Decreasing-Load Test

This test ensures that the scanner/scale responds properly when a heavy object is followed by a significantly smaller object.

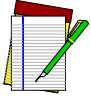

If the upper weight limit for your scale is not set at 15 kilograms, begin by placing weight equaling your upper limit plus 0.8 kilograms.

NOTE

SINGLE INTERVAL	DUAL INTERVAL
1. Place weights that total 15.8 kilograms.	1. Place weights that total 15.8 kilograms.
2. Remove weights to leave 10 kilograms on the scale and verify that the display shows between 9.990 and 10.010 kilograms.	2. Remove weights to leave 10 kilograms on the scale and verify that the display shows between 9.990 and 10.010 kilograms.
3. Remove an additional 9.00 kilograms from the scale and check that the scale reads 1.000 kg.	3. Remove an additional 4 kilograms from the scale and check that the scale reads between 5.998 and 6.005 kg.
4. You have completed the Decreasing Load Test.	4. Remove an additional 2 kilograms from the scale and check that the scale reads between 3.998 and 4.002 kg.
	5. Remove an additional 3 kilograms from the scale and check that the scale reads 1 kg.
	6. You have completed the Decreasing Load Test.

Return to Zero Test

This test ensures that, after all other tests have been completed successfully, the scanner/scale returns to zero. Without any weight on the weigh platter, verify that the scale reads 0.000 kg.

You have completed the calibration and verification process for weighing in kilograms.

If the scanner/scale passes all these tests:

1. Remove the weigh platter, install the calibration switch cover and install a seal (if required).
2. Reinstall the weigh platter.

If the scale fails any of these tests, turn to [Section 4, Problem Isolation](#) and follow the troubleshooting procedures for Scale Failures.

NOTES

Chapter 7

Programming

Introduction to Label Programming

The programming bar code labels contained in this manual will allow you to customize and configure features and settings for your scanner (scanner/scale). To ensure full compatibility and proper function, use only the programming bar codes in this manual and other product-specific publications to program scanner features.

This manual has been developed to make it quick and easy for users of all levels to find the information needed to understand and configure features. The following descriptions will help you to determine where to go from here.

Understanding the Basics

If you have little or no prior experience with programming using bar code labels, you should review the first few pages of this section to familiarize yourself with the basics of scanner programming before performing any changes to your configuration.

Using a Bar Code Mask

The programming bar codes in this manual have been placed as multiples per page. In order to present them only one at a time to the scanner, a bar code mask is provided on the opposite side of this page.

Going Green

Thank you for using the bar code mask on the opposite side of this page. This manual has been formatted to minimize the quantity of pages needed to provide all of the programming bar codes available for this product.



Bar Code Mask

Cut a hole in this page and remove it from the manual as indicated to create a sleeve through which bar codes (starting in the following section) can be individually viewed and scanned. It is important that only one bar code at a time be presented to the scanner.

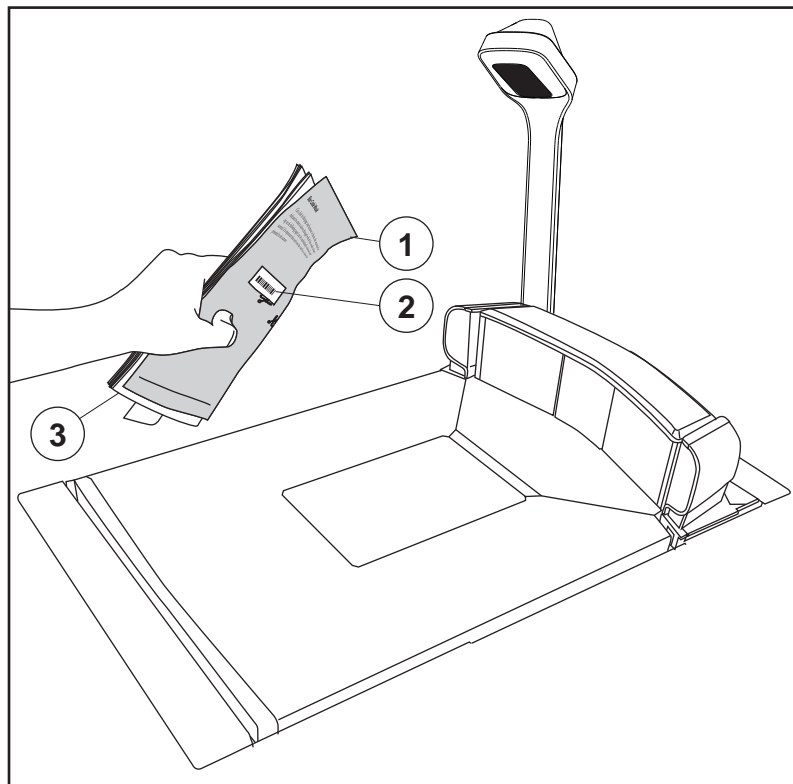

- 1. Bar Code Mask Sheet
- 2. Bar Code
- 3. Manual (folded)

Integrating the Scanner With Your Host System

Your scanner **MUST** be equipped with the correct hardware (interface board, cable, etc.) to properly communicate with your host system. Contact your dealer for information if you have questions about your scanner's hardware compatibility.

You may also want to contact the dealer or your system administrator if you have no record of how your scanner was pre-programmed at the factory. Scanners are typically programmed with the default settings for specific interface types (see [Appendix F, Factory Defaults](#) for more information); however, your scanner may have been custom configured with settings that are unique to your company or application.

Once you know the scanner's current settings, you can determine what changes will be required to allow communication with your host system and/or optional features you choose to modify to customize your installation. After recording the modifications needed, finish reading this section, then turn to the appropriate page and follow the instructions to program the scanner.

When all scanner features are programmed to your satisfaction, the scanner is ready to be placed into operation.

Customizing Your Scanner's Operation

Most scanner programming falls within four general categories:

General Scanner and Scale Features — are features common to all interface types. Examples include beeper adjustments such as volume and length, read verification settings, etc.

EAS Features — control the settings for interfacing with the (optional) EAS device.

Interface Related Features — are the mandatory settings necessary to allow communication with your host terminal. Examples of these settings are: RS-232 baud rate and parity.



CAUTION

It is possible, via programming bar codes, to change the interface type (for example: from RS-232 to IBM Port 17). Great care should be taken to select the correct interface type, since you can cause damage to the scanner and/or POS terminal by attempting to change to an incompatible interface. ALWAYS make interface selections with the host cable DISCONNECTED.



NOTE

Ensure that your planned modifications are compatible with the current interface. For example, baud rate selections are only valid in the RS-232 interface. The scanner will sound an error tone when scanning programming labels for features invalid to the current interface group.

Symbology Programming — gives the scanner the capability to autodiscriminate as few as one, and as many as all available symbologies. For optimal scanner performance enable only those symbologies required. Additionally the scanner may be programmed with the standard options available for the various symbologies, such as check digit, minimum label length, fixed and variable length bar codes, etc.

If you experience difficulties, have questions or require additional information, contact your local distributor, or call your dealer or sales representative.

Programming Overview

The scanner's programmable feature settings can be modified to accommodate your system's unique requirements. These settings can be communicated to the scanner in one of two ways:

1. Commands can be sent directly from the host. A limited set of host commands are available. Refer to [Appendix E](#) for more details or contact Tech Support.
2. Programming bar code labels can also be used to modify the scanner's programmable settings. This manual provides the bar code labels and instructions necessary to configure the scanner's features and options.



When you program the scanner using any of the methods above, the scanner will store the changes until reprogrammed or returned to factory defaults.

NOTE

3. Alternatively, a configuration utility called "Scanalyzer" can be used to program the scanner.

Programming via Handheld Device

The scanner can also accept programming via either its USB or auxiliary ports using a handheld scanning device. Eligible handheld devices must have the ability to transmit the C128 1D and Data Matrix 2D programming bar codes presented in this manual. Several Datalogic™ handheld models support this functionality. Handheld data format requirements (baud rate, parity, etc.) are presented in [Appendix G](#) of this manual. Unless it is a USB handheld model, the programmable feature, Aux Port Mode, must also be set to "External Handheld Input" to allow operation.

What Is Programming Mode?

Programming Mode is a state in which the scanner must be placed in order to accept commands via programming bar code labels. When programming using the bar code labels in this manual, the scanner is typically placed in Programming Mode by scanning the Enter/Exit Programming Mode label.

While in the Programming Mode, the scanner only recognizes the special programming bar codes contained in this programming guide. See [Appendix A](#) for information about scanner indications while in the Programming Mode.

Entering and Exiting Programming Mode.

When needed, an Enter/Exit Programming Mode bar code is available at the top of each programming page.



Your scanner will read the 2D programming bar codes in this manual while in Programming Mode, regardless of whether 2D reading capability has been enabled as an option.

NOTE

Programming Session

A typical programming session is conducted as follows:

1. Scan the Enter/Exit Programming Mode bar code to place the scanner in Programming Mode. Depending upon its current programming, the scanner may emit a beep or beeps, indicating it has read the bar code and the green LED will flash on and off slowly while the scanner remains in Programming Mode. Normal scanning functions are disabled.
2. Scan the programming bar code(s) that is (are) specially encoded to make the desired changes. With few exceptions¹, the scanner will emit a triple beep each time you scan a valid programming bar code.



Not all features are available for all interfaces and the scanner will sound an error tone when scanning programming bar codes for features invalid to the current interface. Only features supported by the currently active interface will be implemented.

NOTE



If a bar code is scanned that changes the scanner's interface, all previous configuration items scanned in the programming session are lost.

NOTE

Additionally, when programming a feature requiring you to scan single digits to set a multi-digit number, such as Minimum Label Length, scanning the Enter/Exit Programming Mode bar code (or any item tag/item value bar code) before completing all input will result in an error tone and cause the scanner to exit Programming Mode. Under these circumstances, the current feature you were trying to set is thrown out; any previous bar codes scanned during the session will take effect.



It is recommended that programming sessions be limited to one feature at a time. Should you make a mistake in the programming sequence, it can be difficult to discover where an error has been made if several features are programmed at once. Additionally, it can be confusing to determine which features may or may not have been successfully set following such a session.

NOTE

3. Scan the Enter/Exit Programming Mode bar code to save any new settings and exit Programming Mode. The scanner will sound a beep and reset upon exiting Programming Mode, and the green LED will return to its usual state (on steady or off).

The scanner will exit Programming Mode under the following conditions:

- the programming sequence has been completed or the Enter/Exit Programming Mode bar code is scanned
- five minutes have passed without scanning activity. Any data programmed during the current session will be ignored, and the scanner will reset and revert to its condition previous to initiating the exited session.

1. Some features, such as Minimum Label Length, require you to select the label's length by scanning a series of single-digit bar codes. A single 'good read' beep is sounded when scanning these single digits in Programming Mode. Only the final required digit in the sequence will produce a triple beep when scanned, indicating a successfully programmed feature.

—power is disconnected. Disconnecting power during Programming Mode, before scanning the Enter/Exit Programming Mode bar code, will cause all new settings to be ignored¹. On power-up, the scanner will return to previous settings.

4. Maintain a good record of all changes made to ensure that you know if the original factory settings have been changed.

Programming Sequence

To modify a scanner feature (item), the programming bar codes contained in this manual must be scanned in a given sequence depending upon the feature being programmed (as shown in [Table 8](#)). There are three possible programming sequences:



If the scanner's interface type must be changed, always be sure that interface configuration is the FIRST item scanned during a programming session. (Selecting an interface type resets ALL other configuration items to the stored values for that interface type.)

NOTE

- A. Programming sample A (the most commonly used format) demonstrates how three bar codes are scanned in sequence to do the following:
 1. Place the scanner in Programming Mode (Enter/Exit Programming Mode bar code).
 2. Scan the Item Tag that will enable the new feature.
 3. End the programming session and reset the scanner (Enter/Exit Programming Mode bar code).
- B. Sample B provides an example of a programming feature requiring the entry of a range value. Like sample A, the scanner is placed in Programming Mode and an Item Tag¹ is scanned. Then, a value must be entered before ending the programming session. In the example, three digits must be scanned from the number pad in [Appendix C](#). This type of format, requiring several bar codes, is necessary to allow flexible programming for item values with larger numeric ranges.



Unless otherwise directed, item value settings (for example, label lengths) are entered as decimal numbers. Only enter values as hexadecimal when instructed to do so.

NOTE

- C. The programming sequence shown in example C requires scanning of a single, extended length bar code. This special programming bar code contains all the data necessary to enter Programming Mode, set the Item Tag² and Item Value, and exit Programming Mode (all in one step).

1. Exception: If an interface bar code had been read while in Programming Mode, the scanner will operate on the default settings for the new interface.

2. An "Item Tag" is a term used to describe an assigned number, which is encoded in a programming bar code, that toggles (selects, enables, disables, etc.) a specific programming feature

Table 8. Programming Sequence

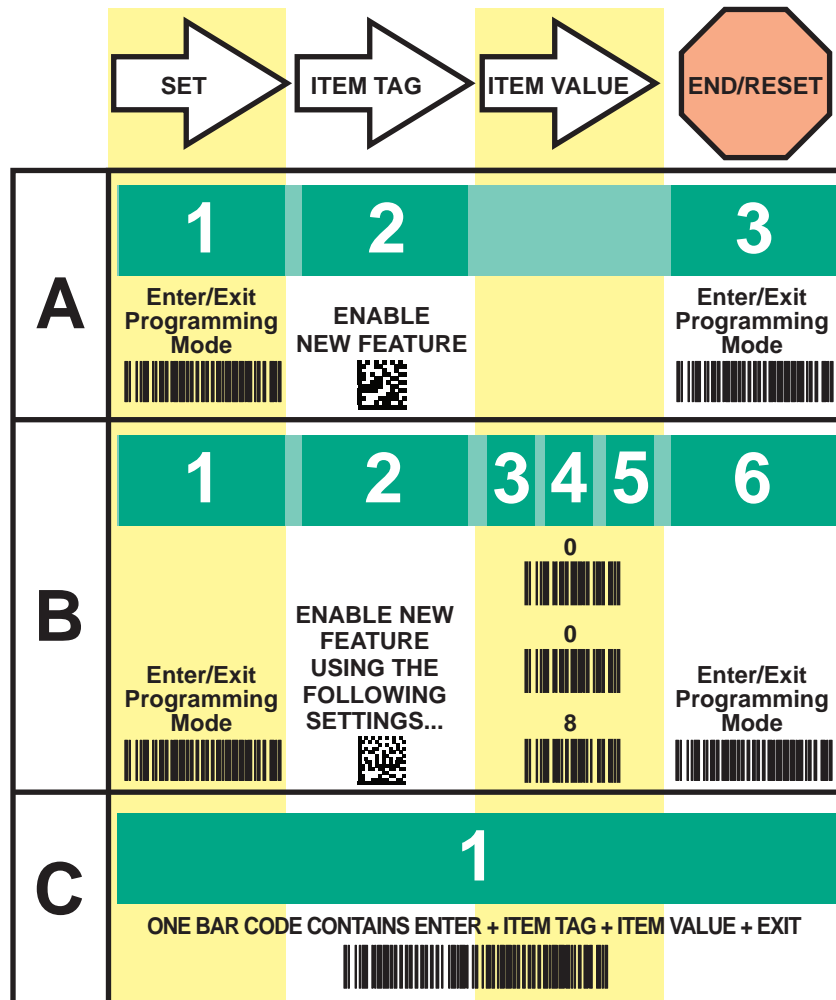

LED and Beeper Indicators

The scanner provides a set of indicators that verify/announce the various scanner functions. See [Appendix A](#) for more details.

If You Make a Mistake...

If, during a programming session, you find that you are unsure of the scanner's settings or wish to reset the scanner's configuration, use the Return to Factory Settings label below to return the scanner's configuration to the factory settings. Scanning this label will also reset any changes made during previous programming sessions.

Return to Factory Settings

Scan the bar code below to return the scanner to the default settings configured at the factory for the currently active interface. This bar code is typically used to return the scanner to a "known" operating state when the present programming status is not known, faulty, or suspect.



Use this bar code with caution, since it will reset ALL features that may have been programmed since the scanner's installation.

CAUTION



DO NOT scan the Enter/Exit Programming Mode bar code before and after scanning this bar code.

NOTE

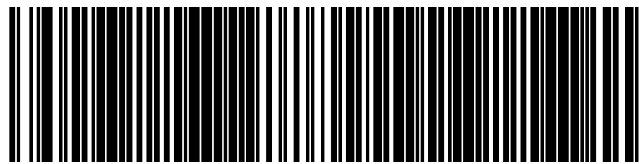

RETURN TO FACTORY SETTINGS

Test Mode

Use this feature to place the scanner into a testing, or “demo” mode. This special mode disables the scanner interface, meaning that bar code data is not sent out to the host via the scanner interface. This allows the bar code to be scanned continuously without requiring a response from the POS terminal.

Enable Test Mode — The scanner will scan labels and beep without sending data.

Disable Test Mode — The scanner will return to the original configuration before Test Mode was entered.



DO NOT scan the Enter/Exit Programming Mode bar code before and after scanning the bar codes on this page.

NOTE

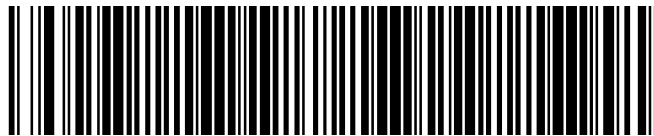

TEST MODE = DISABLE

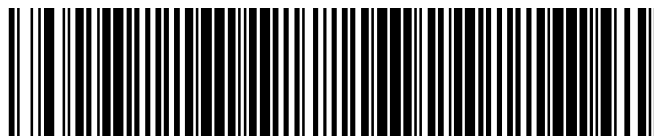

TEST MODE = ENABLE

NOTES

Chapter 8

Imaging Features

Top Down Reader (TDR) and Mobile Commerce Imaging Features

The TDR and its multiple capabilities are optional features with which your scanner may be equipped. The imaging features in this chapter pertain only to the TDR and Mobile Commerce reader. [Figure 55](#), #1 illustrates the TDR's top down reading capability and #2 demonstrates the Mobile Commerce reader function.

Figure 55. Top Down Reader and Mobile Commerce Reader

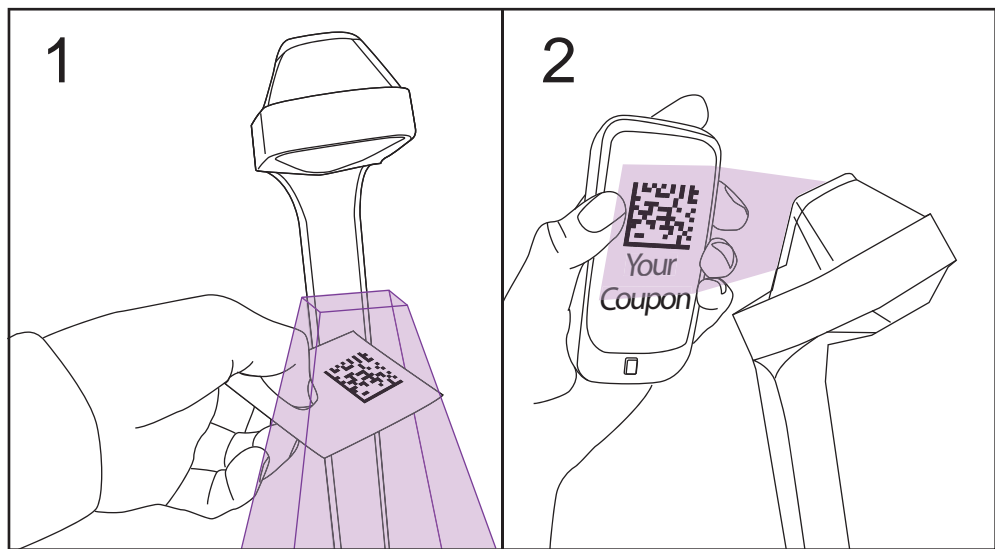

1	Top Down Reader (TDR)
2	Mobile Commerce Reader

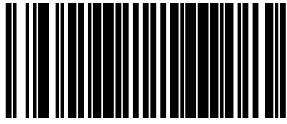

Mobile Commerce Reader Enable

The Mobile Commerce reader is an optional customer-facing imager (see [Figure 55, #2](#)) which captures images such as coupons from a cell phone screen. Use the bar codes below to enable or disable the Mobile Commerce reader.

1. Scan the ENTER/EXIT Programming Mode bar code.
2. Scan your selection from the bar codes below. You'll need to cover any unused bar codes on this and the facing page to ensure that the scanner reads only the bar code you intend to scan.
3. Complete the programming sequence by scanning the ENTER/EXIT Programming Mode bar code.



Mobile Commerce Reader = Disable



Mobile Commerce Reader = Enable





Mobile Commerce Imagers

This feature specifies which imagers (see [Figure 55](#)) participate in a cell read¹:

- Mobile Commerce only
- Mobile Commerce and Top Down Reader (TDR)

To set the desired option:

1. Scan the Enter/Exit Programming Mode bar code.
2. Scan your selection from the bar codes below. You'll need to cover any unused bar codes on this and the facing page to ensure that the scanner reads only the bar code you intend to scan.
3. Complete the programming sequence by scanning the Enter/Exit Programming Mode bar code.

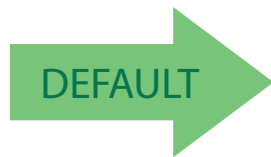

Mobile Commerce Imagers = Mobile Commerce only



Mobile Commerce Imagers = Mobile Commerce + TDR

1. A cell read is a read which takes place on a device with a highly reflective display screen. Examples are cell phones, tablets, and some PC monitors

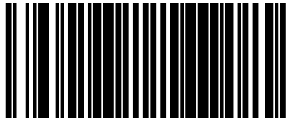

Mobile Commerce Button Function

This feature determines if pushing the Mobile Commerce button toggles the Mobile Commerce reader on and off, or just turns it on for a short period of time.

1. Scan the ENTER/EXIT Programming Mode bar code.
2. Scan your selection from the bar codes below. You'll need to cover any unused bar codes on this and the facing page to ensure that the scanner reads only the bar code you intend to scan.
3. Complete the programming sequence by scanning the ENTER/EXIT Programming Mode bar code.

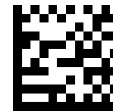
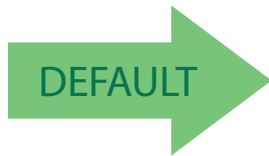

Mobile Commerce Button Function = Toggle

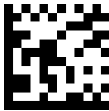

Mobile Commerce Button Function = Activate with Timeout



Mobile Commerce Button Function = Always on



TDR Enable

The Top Down Reader (TDR) function is an optional down-facing imager (see [Figure 55, #1](#)) which can be used to expand the scanner's good read zone. Use the bar codes below to enable or disable the TDR.

1. Scan the ENTER/EXIT Programming Mode bar code.
2. Scan your selection from the bar codes below. You'll need to cover any unused bar codes on this and the facing page to ensure that the scanner reads only the bar code you intend to scan.
3. Complete the programming sequence by scanning the ENTER/EXIT Programming Mode bar code.



TDR = Disable



TDR = Enable



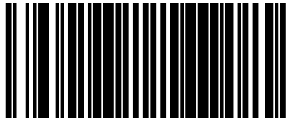

Image Camera

This option selects the default imager for picture taking (optional camera functionality).

Choices are:

Vertical — Vertical window imager selected for taking pictures.

Horizontal — Horizontal window imager selected for taking pictures.

TDR — Top Down Reader (TDR) imager selected for taking pictures.

Mobile Commerce — Mobile Commerce (customer-facing) imager selected for taking pictures.



Image Camera = Vertical



Image Camera = Horizontal

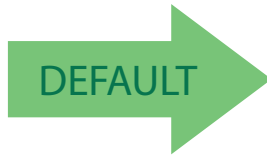

Image Camera = TDR



Image Camera = Mobile Commerce



Image Format

This feature specifies the output format for images taken using the camera function of the TDR.

Choices are:

- JPG
- BMP
- TIFF

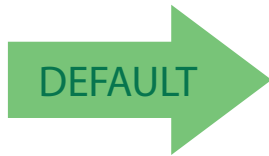

Image Format = JPG



Image Format = BMP



Image Format = TIFF

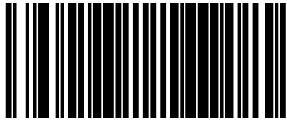

Image Size

This feature specifies the size of the captured image.

Choices are:

VGA — Video Graphics Array. 640 x 480 pixels.

WVGA — Wide Video Graphics Array, various physical sizes, 16:9 shape

Full Size — Maximum image height and width. Largest image.

Half VGA — Half of the size of a regular VGA image, 320 x 240 pixels. Smallest image.

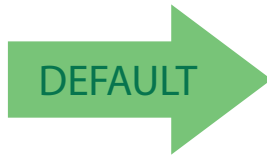

Image Size = VGA



Image Size = WVGA



Image Size = Full Size



Image Size = Half VGA



Image Brightness

Specifies the image brightness value. The selectable range is from 0 to 10, with 10 being the brightest.



Image Brightness = 0



Image Brightness = 1



Image Brightness = 2



Image Brightness = 3



Image Brightness = 4



Image Brightness = 5



Image Brightness = 6



Image Brightness = 7

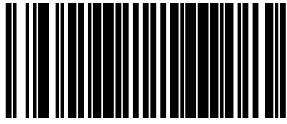

Enter/Exit Programming Mode

Image Brightness (continued)



Image Brightness = 8



Image Brightness = 9



Image Brightness = 10



Image Contrast

This feature sets the contrast level for a captured image. The selectable range is from 0 to 10, with 0 being the lowest and 10 being the highest contrast.



Image Contrast = 0



Image Contrast = 1



Image Contrast = 2



Image Contrast = 3



Image Contrast = 4



Image Contrast = 5



Image Contrast = 6



Image Contrast = 7



Enter/Exit Programming Mode

Image Contrast (continued)



Image Contrast = 8



Image Contrast = 9



Image Contrast = 10



Chapter 9

General Scanner and Scale Features

1D Double Read Timeout

The 1D Double Read Timeout feature specifies the minimum allowable time which must pass before reading the same 1D label again (e.g. two identical items in succession).

To set the Double Read Timeout:

1. Scan the Enter/Exit Programming Mode bar code.
2. Scan your selection from the bar codes below. You'll need to cover any unused bar codes on this and the facing page to ensure that the scanner reads only the bar code you intend to scan.
3. Complete the programming sequence by scanning the Enter/Exit Programming Mode bar code.



If the incidence of multiple reads is not acceptable, increase the Double Read Timeout setting to a higher value.

NOTE



1D Double Read Timeout = 300ms



1D Double Read Timeout = 400ms



1D Double Read Timeout = 600ms



1D Double Read Timeout = 800ms

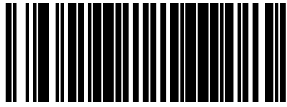

Enter/Exit Programming Mode

2D Double Read Timeout

The 2D Double Read Timeout feature specifies the minimum allowable time which must pass before reading the same 2D label again (e.g. two identical items in succession).

To set this feature:

1. Scan the Enter/Exit Programming Mode bar code.
2. Scan your selection from the bar codes below. You'll need to cover any unused bar codes on this and the facing page to ensure that the scanner reads only the bar code you intend to scan.
3. Complete the programming sequence by scanning the Enter/Exit Programming Mode bar code.



If the incidence of multiple reads is not acceptable, increase the Timeout setting to a higher value.

NOTE



2D Double Read Timeout = 300ms



2D Double Read Timeout = 400ms



2D Double Read Timeout = 600ms



2D Double Read Timeout = 700ms



2D Double Read Timeout = 800ms



Label Gone Timeout

Specifies the amount of time in cycles (one cycle = 25ms) that data segments are stored by the software before being discarded if a label has not been successfully decoded during the current “label in volume session,” which is defined as the time between when the label gone time is first started until the label gone timer expires.



This only applies to UPC/EAN labels when segment assembly is enabled.

NOTE

To set the Label Gone Timeout:

1. Scan the Enter/Exit Programming Mode bar code.
2. Scan your selection from the bar codes below. You'll need to cover any unused bar codes on this and the facing page to ensure that the scanner reads only the bar code you intend to scan.
3. Complete the programming sequence by scanning the Enter/Exit Programming Mode bar code.

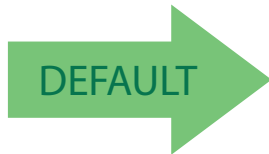

Label Gone Timeout = 0.4 Seconds



Label Gone Timeout = 0.6 Seconds



Label Gone Timeout = 0.8 Seconds

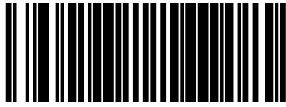

Enter/Exit Programming Mode



Label Gone Timeout = 1.2 Seconds



Label Gone Timeout = 1.6 Seconds

Sleep Mode Timer

This feature specifies the amount of time of inactivity (with no label reads) before the scanner enters sleep mode.

To set this feature:

1. Scan the Enter/Exit Programming Mode bar code.
2. Scan the bar code, [Set Sleep Mode Timer](#) below. You'll need to cover any unused bar codes on this and the facing page to ensure that the scanner reads only the bar code you intend to scan.
3. Scan the appropriate digits from the [Keypad](#) in [Appendix C](#) that represent the desired time interval. The selectable range is 000-255 in 15 second increments. Pad all numbers with leading zeros to yield a three-digit entry (000-255).
4. Scan the Enter/Exit Programming Mode bar code to exit Programming Mode.



Set Sleep Mode Timer

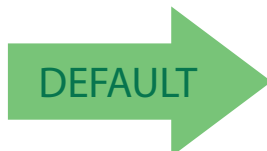

Default setting for this feature is: 5 minutes



1D Inverse Read Control

This configuration item is used to toggle inverted label reading for 1D bar codes, for example, a label printed as white on black as opposed to black on white.

To set this feature:

1. Scan the Enter/Exit Programming Mode bar code.
2. Scan your selection from the bar codes below. You'll need to cover any unused bar codes on this and the facing page to ensure that the scanner reads only the bar code you intend to scan.
3. Complete the programming sequence by scanning the Enter/Exit Programming Mode bar code.

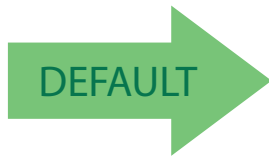

1D Inverse Read Control = Enable



1D Inverse Read Control = Disable



Enter/Exit Programming Mode

2D Inverse Read Control

This configuration item is used to toggle inverted label reading for 2D bar codes, for example, a label printed as white on black as opposed to black on white.

To set this feature:

1. Scan the Enter/Exit Programming Mode bar code.
2. Scan your selection from the bar codes below. You'll need to cover any unused bar codes on this and the facing page to ensure that the scanner reads only the bar code you intend to scan.
3. Complete the programming sequence by scanning the Enter/Exit Programming Mode bar code.

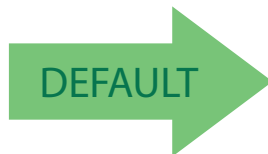

2D Inverse Read Control = Disable



2D Inverse Read Control = Enable

Illumination Control

This feature allows illumination to be turned off when the scanner is disabled.

To set this feature:

1. Scan the Enter/Exit Programming Mode bar code.
2. Scan your selection from the bar codes below:

Disable = Illumination remains on during the time the scanner is disabled.

Enable = Illumination turns off during the time the scanner is disabled.



Enter/Exit Programming Mode

3. Complete the programming sequence by scanning the Enter/Exit Programming Mode bar code.

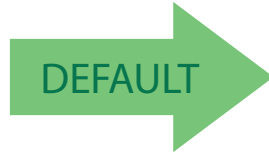

Illumination Control = Disable



Illumination Control = Enable

2D Contrast Improvement

This feature enables / disables the scanner's ability to enhance the image contrast for scanned 2D symbologies.

To set this feature:

1. Scan the Enter/Exit Programming Mode bar code.
2. Scan your selection from the bar codes below. You'll need to cover any unused bar codes on this and the facing page to ensure that the scanner reads only the bar code you intend to scan.
3. Complete the programming sequence by scanning the Enter/Exit Programming Mode bar code.

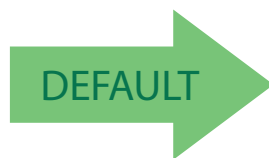

2D Contrast Improvement = Disable



2D Contrast Improvement = Enable



Enter/Exit Programming Mode

Good Read LED Idle State

This feature specifies the state of the green scanner LEDs when the scanner is idle and ready to read a label. Options are:

- Off
- On dim

To set the Scanner LEDs Idle State:

1. Scan the Enter/Exit Programming Mode bar code.
2. Scan your selection from the bar codes below. You'll need to cover any unused bar codes on this and the facing page to ensure that the scanner reads only the bar code you intend to scan.
3. Complete the programming sequence by scanning the Enter/Exit Programming Mode bar code.



Scanner LED Idle State = Off



Scanner LED Idle State = On Dim





Scanner Control Button Options

Configure the Scanner Control Button to one of the following modes of operation:

- Enable all functions: Volume, tone, diagnostics and reset.
- Enable only volume, tone and reset.
- Enable reset only.
- Disable all button functions

To set the desired Scanner Control Button Option:

1. Scan the Enter/Exit Programming Mode bar code.
2. Scan your selection from the bar codes below. You'll need to cover any unused bar codes on this and the facing page to ensure that the scanner reads only the bar code you intend to scan.
3. Complete the programming sequence by scanning the Enter/Exit Programming Mode bar code.

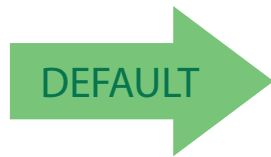

Scanner Control Button = Enable All Functions



Scanner Control Button = Enable Only Volume Tone and Reset



Scanner Control Button = Enable Reset Only



Scanner Control Button = Disable All Functions



Enter/Exit Programming Mode

Power-up Tone Control

Specifies the type of audible indication that is made when entering scanner-active mode on power-up. Choices are:

- No tone
- Play tone

To set the Power-up tone:

1. Scan the Enter/Exit Programming Mode bar code.
2. Scan your selection from the bar codes below. You'll need to cover any unused bar codes on this and the facing page to ensure that the scanner reads only the bar code you intend to scan.
3. Complete the programming sequence by scanning the Enter/Exit Programming Mode bar code.



Power-up Beep Control = No Tone



Power-up Beep Control = Play Tone





Good Read Beep Control

This feature enables/disables scanner beep upon successfully decoding of a label.

To set this feature:

1. Scan the Enter/Exit Programming Mode bar code.
2. Scan your selection from the bar codes below. You'll need to cover any unused bar codes on this and the facing page to ensure that the scanner reads only the bar code you intend to scan.
3. Complete the programming sequence by scanning the Enter/Exit Programming Mode bar code.



Good Read Beep Control = Disable

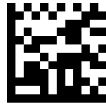

Good Read Beep Control = Enable



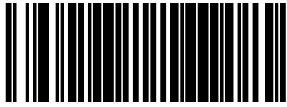

Enter/Exit Programming Mode

Good Read Beep Frequency

Adjusts the scanner's good read beep to sound at low, medium, or high frequency (controls the beeper's pitch/tone).

- Low
- Medium
- High

To set this feature:

1. Scan the Enter/Exit Programming Mode bar code.
2. Scan your selection from the bar codes below. You'll need to cover any unused bar codes on this and the facing page to ensure that the scanner reads only the bar code you intend to scan.
3. Complete the programming sequence by scanning the Enter/Exit Programming Mode bar code.



Good Read Beep Frequency = Low



Good Read Beep Frequency = Medium



Good Read Beep Frequency = High



Good Read Beep Length

Specifies the duration of a good read beep.

To set this feature:

1. Scan the Enter/Exit Programming Mode bar code.
2. Scan the bar code, [Set Good Read Beep Length](#). You'll need to cover any unused bar codes on this and the facing page to ensure that the scanner reads only the bar code you intend to scan.
3. Scan the appropriate digits from the keypad in [Appendix C](#) that represent the desired good read beep length setting. The selectable range is 1-255, which is the timeout in 10-millisecond increments. Times have a tolerance of +/-25%. Pad all single and double digit numbers with leading zeroes to yield a three-digit entry (001-255).

Examples:

001 = 10ms

005 = 50ms

040 = 400ms

250 = 2,500ms (2.5 seconds)

4. The scanner will automatically exit Programming Mode when the appropriate amount of digits have been scanned.



Set Good Read Beep Length

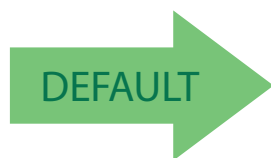

Default setting for this feature is:
008 - 80ms



Enter/Exit Programming Mode

Good Read Beep Volume

Selects the beeper volume upon a good read beep. There are five selectable volumes, with each volume increment adding approximately five decibels to the previous level:

- Low
- Medium Low
- Medium
- Medium High
- High

To set this feature:

1. Scan the Enter/Exit Programming Mode bar code.
2. Scan your selection from the bar codes below. You'll need to cover any unused bar codes on this and the facing page to ensure that the scanner reads only the bar code you intend to scan.
3. Complete the programming sequence by scanning the Enter/Exit Programming Mode bar code.



Good Read Beep Volume = Low



Good Read Beep Volume = Medium Low



Good Read Beep Volume = Medium



Good Read Beep Volume = Medium High

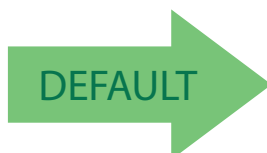

Good Read Beep Volume = High



Good Read When to Indicate

This feature specifies when the scanner will provide indication (beep and/or flash its green LEDs) upon successfully reading a bar code.

- Good Read = Indicate after decode¹
- Good Read = Indicate after transmit
- Good Read = Indicate after CTS goes inactive, then active²
- Good Read = Indicate after each output structure proofed³

To set the Good Read When to Indicate feature:

1. Scan the Enter/Exit Programming Mode bar code.
2. Scan the desired mode bar code from those provided below You'll need to cover any unused bar codes on facing pages to ensure that the scanner reads only the bar code you intend to scan.
3. Complete the programming sequence by scanning the Enter/Exit Programming Mode bar code.

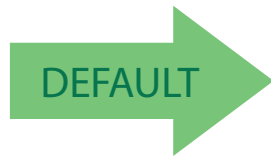

Good Read When to Indicate = After Decode



Good Read When to Indicate = After Transmit



Good Read When to Indicate = After CTS goes Inactive, Then Active



Good Read When to Indicate = After Each Output Structure Proofed

1. For scanner models having intelligent integrated EAS, label transmission (and hence the good read beep) is completed after the EAS logic executes.

2. The "Indicate after CTS goes inactive..." mode applies to RS-232 STD and RS-232 WN interfaces only. If set to this mode in other interfaces, "Indicate after decode" mode will be implemented.

3. When beeping after each output structure decoded, if there are multiple output structures, there is a delay after the beep has finished. This delay is equal to the [Good Read Beep Length](#).



Enter/Exit Programming Mode

Scale Zero Button and Scale Indicator LED

Here are the configurable options for the Scale Zero Button and Scale Indicator LED:

- Scale Zero Button and Scale Indicator LED active
- Scale Indicator LED active
- Scale Zero Button active
- Scale Zero Button and Scale Indicator LED disconnected



The options on this page are for adaptive scale bonnet integration only.

To set this feature:

1. Scan the Enter/Exit Programming Mode bar code.
2. Scan the desired mode bar code from those provided below You'll need to cover any unused bar codes on facing pages to ensure that the scanner reads only the bar code you intend to scan.
3. Complete the programming sequence by scanning the Enter/Exit Programming Mode bar code.



Scale Zero Button and Scale Indicator LED = Scale Zero Button and Scale Indicator LED active



Scale Zero Button and Scale Indicator LED = Scale Indicator LED active



Scale Zero Button and Scale Indicator LED = Scale Zero Button active



Scale Zero Button and Scale Indicator LED = Scale Zero Button and Scale Indicator LED disconnected



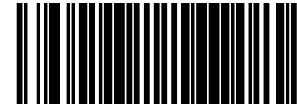

Scale Sentry

This option enables or disables the ability of the scanner to monitor items placed on the platter to ensure they are not overhanging non-weighing surfaces. See the topic [Scale Sentry™ Option](#) in the [Introduction](#) chapter for more information.

To set this feature:

1. Scan the ENTER/EXIT Programming Mode bar code.
2. Scan your selection from the bar codes below. You'll need to cover any unused bar codes on this and the facing page to ensure that the scanner reads only the bar code you intend to scan.
3. Complete the programming sequence by scanning the ENTER/EXIT Programming Mode bar code.



Scale Sentry = Disable



Scale Sentry = Enable



Enter/Exit Programming Mode

Scale Sentry Block Weight Transmission

This option enables or disables weight transmission to the host if a Scale Sentry event is active. When enabled, this feature blocks the transmission of weight data to the host if Scale Sentry has sensed an item or items overhanging the side(s) of the scale platter. Weight will be transmitted when:

- Items are repositioned on the scale platter so as to move them towards the center and away from the edges.
- The Scale Sentry Override Button is pressed.



The Scale Sentry Override Button must be enabled to perform this function via the following feature, .

NOTE

To set this feature:

1. Scan the ENTER/EXIT Programming Mode bar code.
2. Scan your selection from the bar codes below. You'll need to cover any unused bar codes on this and the facing page to ensure that the scanner reads only the bar code you intend to scan.
3. Complete the programming sequence by scanning the ENTER/EXIT Programming Mode bar code.



Scale Sentry Block Weight Transmission = Disable



Scale Sentry Block Weight Transmission = Enable





Scale Sentry Override Button

This option allows a press of the Scale Sentry Override Button to manually clear a Scale Sentry event.

To set this feature:

1. Scan the ENTER/EXIT Programming Mode bar code.
2. Scan your selection from the bar codes below. You'll need to cover any unused bar codes on this and the facing page to ensure that the scanner reads only the bar code you intend to scan.
3. Complete the programming sequence by scanning the ENTER/EXIT Programming Mode bar code.



Scale Sentry Override Button = Disable



Scale Sentry Override Button = Enable



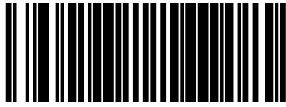

Enter/Exit Programming Mode

Scale Enable

Use this feature to enable or disable scale operation.



Recalibration/recertification may be required when adding scale functionality. Consult your local Weights and Measures authority.

NOTE

To set this feature:

1. Scan the Enter/Exit Programming Mode bar code.
2. Scan your selection from the bar codes below. You'll need to cover any unused bar codes on this and the facing page to ensure that the scanner reads only the bar code you intend to scan.
3. Complete the programming sequence by scanning the Enter/Exit Programming Mode bar code.



Scale = Disable



Scale = Enable





Scale Diagnostics Mode

Use this feature to allow or disallow the ability of an operator to initiate the advanced feature, scale diagnostics.

To set this feature:

1. Scan the Enter/Exit Programming Mode bar code.
2. Scan your selection from the bar codes below. You'll need to cover any unused bar codes on this and the facing page to ensure that the scanner reads only the bar code you intend to scan.
3. Complete the programming sequence by scanning the Enter/Exit Programming Mode bar code.



Scale Diagnostics Mode = Disable



Scale Diagnostics Mode = Enable





Enter/Exit Programming Mode

Scale Stale Weight Timeout

This option specifies the amount of time that scale data is presented to the host before being discarded.

To set this feature:

1. Scan the Enter/Exit Programming Mode bar code.
2. Scan the bar code, [Set Scale Stale Weight Timeout](#) below. You'll need to cover any unused bar codes on this and the facing page to ensure that the scanner reads only the bar code you intend to scan.
3. Scan the appropriate digits from the [Keypad](#) in [Appendix C](#) that represent the desired time interval. The selectable range is 20-33 in 10ms increments.

Scan the Enter/Exit Programming Mode bar code to exit Programming Mode.



Set Scale Stale Weight Timeout

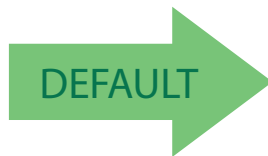

Default setting for this feature is: 330 milliseconds



Scale Enforced Zero Return

This feature sets the mode of enforcing the scale re-zeroing operation:

- Disable
- Non-zero for more than 4 minutes OR below zero
- Non-zero for more than 4 minutes OR below zero OR no zero between weights

To set this feature:

1. Scan the Enter/Exit Programming Mode bar code.
2. Scan your selection from the bar codes below. You'll need to cover any unused bar codes on this and the facing page to ensure that the scanner reads only the bar code you intend to scan. The strategy is to select the lowest possible filter level needed that allows normal scale operation.
3. Complete the programming sequence by scanning the Enter/Exit Programming Mode bar code.



Scale Enforced Zero Return = Disable



Scale Enforced Zero Return = Non Zero for More Than 4 minutes OR Below Zero



Scale Enforced Zero Return = Non Zero for More Than 4 minutes OR Below Zero OR No Zero Between Weights



Scale Enforced Zero Return = Non Zero for 4 minutes



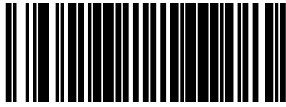

Enter/Exit Programming Mode

Scale Interface Type

Use this feature to select the scale interface type. Choices are::

- No scale interface
- IBM 46XX (Port 17 ignored)
- Mettler Toledo 8217
- USB (IBM ignored)
- RS-232 - SASI
- RS-232 - ICL
- USB (HID weighing device ignored)
- RS-232 (Single Cable ignored)

To set this feature:

1. Scan the Enter/Exit Programming Mode bar code.
2. Scan your selection from the bar codes below. You'll need to cover any unused bar codes on this and the facing page to ensure that the scanner reads only the bar code you intend to scan.
3. Complete the programming sequence by scanning the Enter/Exit Programming Mode bar code.



Scale Interface Type = No Scale Interface

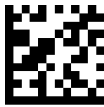

Scale Interface Type = IBM 46XX (Port 17 Ignored)



Scale Interface Type = Mettler Toledo (8217 ignored)



Scale Interface Type = USB (IBM ignored)



Scale Interface Type (continued)

Remember to cover any unused bar codes on this and the facing page to ensure that the scanner reads only the bar code you intend to scan.

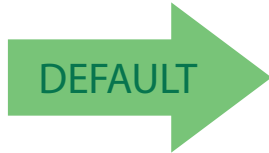

Scale Interface Type = RS-232 - SASI



Scale Interface Type = RS-232 - ICL



Scale Interface Type = USB (HID Weighing Device Ignored)



Scale Interface Type = RS-232 (Single Cable Ignored)

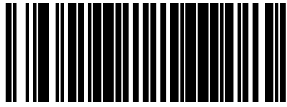

Enter/Exit Programming Mode

Scale Calibration Notification

This option enables a notification that scale calibration has taken place.

To set this feature:

1. Scan the Enter/Exit Programming Mode bar code.
2. Scan your selection from the bar codes below. You'll need to cover any unused bar codes on this and the facing page to ensure that the scanner reads only the bar code you intend to scan.
3. Complete the programming sequence by scanning the Enter/Exit Programming Mode bar code.

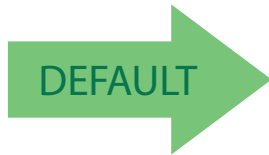

Scale Calibration Notification = Disable



Scale Calibration Notification = Enable



Scale Intercharacter Delay

With regard to scale functions, this feature specifies a delay between the end of one character and the beginning of the next in 10-millisecond increments.

To set the Scale Intercharacter Delay:

1. Scan the Enter/Exit Programming Mode bar code.
2. Scan the bar code below, [Set Scale Intercharacter Delay](#). You'll need to cover any unused bar codes on this and the facing page to ensure that the scanner reads only the bar code you intend to scan.
3. Scan the appropriate digits from the [Keypad](#) in [Appendix C](#) that represent the desired delay. The selectable range is 0-255, which is the delay in 10-millisecond increments. Pad all single and double digit numbers with leading zeroes to yield a three-digit entry (000-255).

Examples:

001 = 10ms

005 = 50ms

040 = 400ms

100 = 1,000ms (1 second)

4. The scanner will automatically exit Programming Mode when the appropriate amount of digits have been scanned.



Set Scale Intercharacter Delay

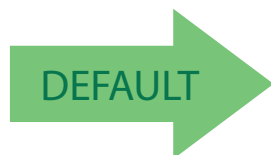

Default setting for this feature is:
00 - No Intercharacter Delay

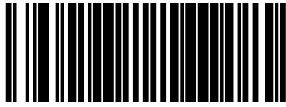

Remote Display — Enable/Disable

The scanning-scale can be configured to operate with or without a Remote Display.



NOTE

Recalibration/recertification may be required when adding a Remote Display. Consult your local Weights and Measures authority.

If this feature is enabled the scanner will expect that it is connected to a Remote Display, and will indicate an error if one is not. See [Error Codes](#) in the [Problem Isolation](#) section for more information.

To set this feature:

1. Scan the Enter/Exit Programming Mode bar code.
2. Scan your selection from the bar codes below. You'll need to cover any unused bar codes on this and the facing page to ensure that the scanner reads only the bar code you intend to scan.
3. Complete the programming sequence by scanning the Enter/Exit Programming Mode bar code.



Remote Display = Disable

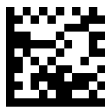

Remote Display = Enable





Auxiliary Port Mode

Selects the usage for the scanner's optional auxiliary port. The choices listed below are mutually exclusive (only one option can be active at a time).

- Disabled — Port is inactive
- External Handheld Input — Supports Datalogic™ handheld scanners (QuickScan™ 1000, QuickScan™ 6000, PowerScan™) as well as other models such as the Symbol® HotShot. Call your dealer for more information about supported devices.



Cable pinout information for the Aux Port is provided in Appendix B of this manual. A connected handheld scanner must be configured to transmit data as outlined in Appendix E.

NOTE

To set this feature:

1. Scan the Enter/Exit Programming Mode bar code.
2. Scan your selection from the bar codes below. You'll need to cover any unused bar codes on this and the facing page to ensure that the scanner reads only the bar code you intend to scan.
3. Complete the programming sequence by scanning the Enter/Exit Programming Mode bar code.

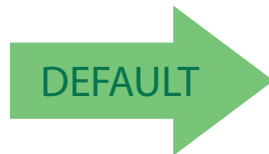

Auxiliary Port Mode = Disable



Auxiliary Port Mode = External Handheld Input

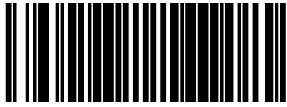

Enter/Exit Programming Mode

Auxiliary USB Mode

This option specifies the function of the USB auxiliary port.

To set this feature:

1. Scan the Enter/Exit Programming Mode bar code.
2. Scan your selection from the bar codes below. You'll need to cover any unused bar codes on this and the facing page to ensure that the scanner reads only the bar code you intend to scan.
3. Complete the programming sequence by scanning the Enter/Exit Programming Mode bar code.

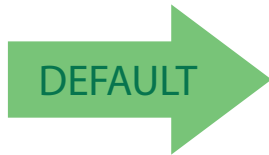

Auxiliary USB Mode = Disable



Auxiliary USB Mode = PIR/CT Output + Diagnostics
Reporting



Productivity Index Reporting (PIR) / Cashier Training (CT)

When PIR/CT is enabled, label quality data is appended to decoded data before being presented to the POS. The PIR feature allows the scanner to provide information to an external computer indicating how easy the label was to read. CT allows the scanner to provide feedback to the cashier on how to scan in a more ergonomic fashion.

To set this feature:

1. Scan the Enter/Exit Programming Mode bar code.
2. Scan your selection from the bar codes below. You'll need to cover any unused bar codes on this and the facing page to ensure that the scanner reads only the bar code you intend to scan.
3. Complete the programming sequence by scanning the Enter/Exit Programming Mode bar code.

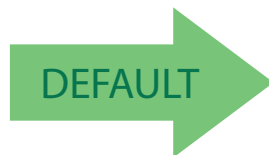

PIR / CT = Disable



PIR / CT = Enable

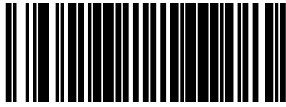

Enter/Exit Programming Mode

PIR/CT Auxiliary Port Baud Rate

This feature specifies the baud rate of the auxiliary port when operating in PIR/CT Mode.



This setting is valid ONLY when Auxiliary Port Mode is set to PIR/CT + Diagnostics Reporting.

NOTE

To set this feature:

1. Scan the Enter/Exit Programming Mode bar code.
2. Scan your selection from the bar codes below. You'll need to cover any unused bar codes on this and the facing page to ensure that the scanner reads only the bar code you intend to scan.
3. Complete the programming sequence by scanning the Enter/Exit Programming Mode bar code.



PIR/CT Auxiliary Port Baud Rate = 1200



PIR/CT Auxiliary Port Baud Rate = 2400



PIR/CT Auxiliary Port Baud Rate = 4800



PIR/CT Auxiliary Port Baud Rate = 9600



PIR/CT Auxiliary Port Baud Rate = 19200



PIR/CT Auxiliary Port Baud Rate = 38400



Enter/Exit Programming Mode

PIR/CT Auxiliary Port Baud Rate (continued)



PIR/CT Auxiliary Port Baud Rate = 57600

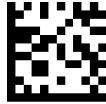

PIR/CT Auxiliary Port Baud Rate = 115200



Enter/Exit Programming Mode

NOTES

Chapter 10

EAS Features

EAS Features — Sensormatic



NOTE

These features control the Sensormatic® AMB-9010 or ScanMaxPro EAS controller box. This orderable option is installed at the time of manufacture. See [EAS Features — Checkpoint](#) on page 160 to set options for the Checkpoint® EAS system.

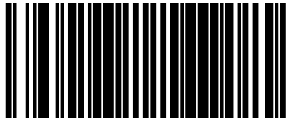

EAS Mode

This controls the mode of operation for interfacing with the Sensormatic® AMB-9010 or ScanMaxPro EAS controller box. Choices are:

- Disabled = EAS deactivation turned off.
- Coupled Mode = EAS tag is deactivated only upon successful scanning of an item's bar code or via EAS Exception Button.
- Decoupled Mode = EAS deactivation is performed independently of bar code scanning.
- Hybrid Mode = EAS system is armed whenever the scanner is enabled and the deactivation beep is sounded when an EAS tag is deactivated.
- Host Coupled Mode = Fundamental controls and notification of various EAS events are provided to the POS system.



NOTE

Deactivation can only be initiated manually if the EAS Exception Button is armed to do so. Reference the feature [EAS Exception Button](#) on page 155 for more information.

To set this feature:

1. Scan the Enter/Exit Programming Mode bar code.
2. Scan your selection from the bar codes below. You'll need to cover any unused bar codes on this and the facing page to ensure that the scanner reads only the bar code you intend to scan.
3. Complete the programming sequence by scanning the Enter/Exit Programming Mode bar code.

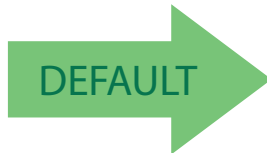

EAS Mode = Disable



EAS Mode = Coupled Mode



EAS Mode (continued)

Remember to cover any unused bar codes on this and the facing page to ensure that the scanner reads only the bar code you intend to scan.



EAS Mode = Decoupled Mode



EAS Mode = Hybrid Mode



EAS Mode = Host Coupled Mode

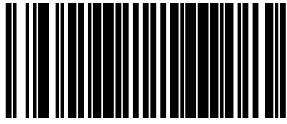

Enter/Exit Programming Mode

EAS Notification

This feature specifies the output mode and activation of EAS event notification when operating in Coupled Mode.

To set this feature:

1. Scan the Enter/Exit Programming Mode bar code.
2. Scan your selection from the bar codes below. You'll need to cover any unused bar codes on this and the facing page to ensure that the scanner reads only the bar code you intend to scan.
3. Complete the programming sequence by scanning the Enter/Exit Programming Mode bar code.

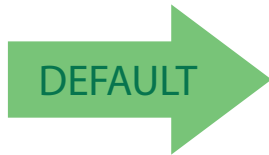

EAS Notification = Notification over POS Port



EAS Notification = Disable



EAS Security Level

This feature defines the level of EAS security for operating in coupled mode.

To set this feature:

1. Scan the Enter/Exit Programming Mode bar code.
2. Scan your selection from the bar codes below. You'll need to cover any unused bar codes on this and the facing page to ensure that the scanner reads only the bar code you intend to scan.
3. Complete the programming sequence by scanning the Enter/Exit Programming Mode bar code.

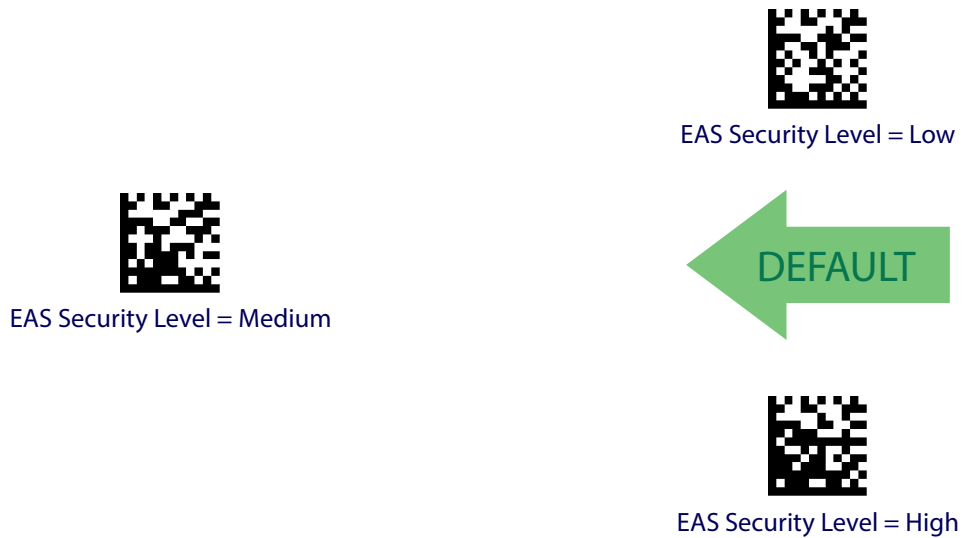

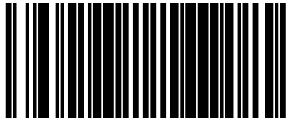

EAS Good Beep Mode

This feature sets the mode of operation for the EAS deactivation beep while operating in coupled mode.

To set this feature:

1. Scan the Enter/Exit Programming Mode bar code.
2. Scan your selection from the bar codes below. You'll need to cover any unused bar codes on this and the facing page to ensure that the scanner reads only the bar code you intend to scan.
3. Complete the programming sequence by scanning the Enter/Exit Programming Mode bar code.

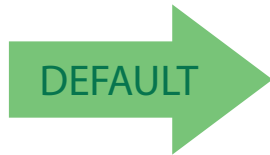

EAS Good Beep Mode = Disable



EAS Good Beep Mode = Beep on Deactivate



EAS Good Beep Mode = Beep on Verify



EAS Beep Duration

Sets the duration of the EAS successful deactivation beep, specified in 10ms increments. The beep only occurs if EAS mode is not disabled.

To set the EAS Beep Duration:

1. Scan the Enter/Exit Programming Mode bar code.
2. Scan the bar code, [Set EAS Beep Duration](#) below. You'll need to cover any unused bar codes on this and the facing page to ensure that the scanner reads only the bar code you intend to scan.
3. Scan the appropriate digits from the [Keypad in Appendix C](#) that represent the desired EAS Beep Duration. The selectable range is 0-255, which is the timeout in 10-millisecond increments. Pad all single and double digit numbers with leading zeroes to yield a three-digit entry (000-255).

Examples:

000 = EAS beep disabled

001 = 10ms

005 = 50ms

040 = 400ms

250 = 2,500ms (2.5 seconds)

4. Complete the programming sequence by scanning the Enter/Exit Programming Mode bar code.



Set EAS Beep Duration

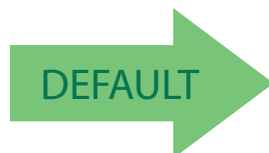

Default setting for this feature is:
008 - 80ms

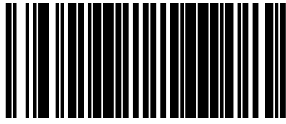

EAS Retry Count

This feature sets the number of times the deactivation sequence (defined by the feature, “EAS Deactivation Duration — Retry”) is restarted after a failed deactivation attempt.

To set this feature:

1. Scan the Enter/Exit Programming Mode bar code.
2. Scan the bar code, [Set EAS Retry Count](#) below. You’ll need to cover any unused bar codes on this and the facing page to ensure that the scanner reads only the bar code you intend to scan.
3. Scan the appropriate digits from the [Keypad in Appendix C](#) that represent the desired number. The selectable range is 0-15 resets. Pad all single and double digit numbers with leading zeroes to yield a two-digit entry (00-15).



A setting of zero specifies no deactivation retries upon failed deactivation attempt.

NOTE

4. Complete the programming sequence by scanning the nter/Exit Programming Mode bar code.



Set EAS Retry Count

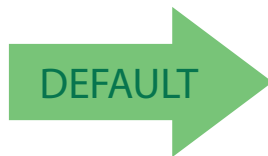

Default setting for this feature is:
03 - Retry EAS Deactivation three times



EAS Exception Button

This feature is for use in Coupled Mode¹. When it is enabled, EAS deactivation can be manually initiated by placing the item with the EAS tag downstream² of the horizontal scan window and pushing the EAS Exception Push Button.



NOTE

The scanner emits a clicking sound while in deactivation state.

Duration of deactivation state is determined by the feature, EAS Deactivation Duration — Manual.

Options are:

- **DISABLE** — EAS Exception Button is disabled.
- **ENABLE ALWAYS** — The EAS Exception Button is always enabled.
- **ENABLE ONLY WHEN SCANNER ENABLED** — The EAS Exception Button is only available when the scanner is enabled and running.



NOTE

Statistics are collected each time the EAS Exception Button is used to deactivate an EAS tag.

To set this feature:

1. Scan the Enter/Exit Programming Mode bar code.
2. Scan your selection from the bar codes below. You'll need to cover any unused bar codes on this and the facing page to ensure that the scanner reads only the bar code you intend to scan.

Complete the programming sequence by scanning the Enter/Exit Programming Mode bar code.



EAS Exception Button = Disabled



EAS Exception Button = Enable Always

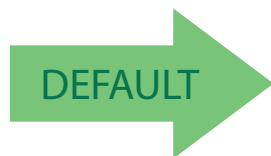

EAS Exception Button = Enable ONLY When Scanner Enabled

1. See [EAS Mode on page 148](#) for more information about Coupled Mode.
 2. "Downstream" in this case is defined as being the downstream side of the scan window from the direction of product flow, or scanning direction.

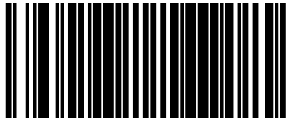

EAS Deactivation Duration — Coupled

Specifies the amount of time EAS deactivation is operative once the function has been initiated following a bar code read.



This setting pertains only to units configured for EAS Coupled Mode. Reference the [EAS Mode](#) description for more information about Coupled and Decoupled EAS operation.

NOTE

To set the EAS Deactivation Duration — Coupled:

1. Scan the Enter/Exit Programming Mode bar code.
2. Scan the bar code, [Set EAS Deactivation Duration — Coupled](#) below. You'll need to cover any unused bar codes on this and the facing page to ensure that the scanner reads only the bar code you intend to scan.
3. Scan the appropriate digits from the [Keypad in Appendix C](#) that represent the desired duration. The selectable range is 1-255, which is the duration in 10-millisecond increments. Pad all single and double digit numbers with leading zeroes to yield a three-digit entry (001-255).

Examples:

005 = 50ms

040 = 400ms

250 = 2,500ms (2.5 seconds)

4. The scanner will automatically exit Programming Mode when the appropriate amount of digits have been scanned.



Set EAS Deactivation Duration — Coupled



Default setting for this feature is:
040 = 400ms



EAS Deactivation Duration — Retry

Specifies the amount of time EAS deactivation is operative once the function has been initiated following EAS tag detection (prior to bar code read).



This setting pertains only to units configured for EAS Coupled Mode. Reference the [EAS Mode](#) description for more information about Coupled and Decoupled EAS operation. Also reference [EAS Retry Count](#).

NOTE

To set the EAS Deactivation Duration — Retry:

1. Scan the Enter/Exit Programming Mode bar code.
2. Scan the bar code, [Set EAS Deactivation Duration — Retry](#) below. You'll need to cover any unused bar codes on this and the facing page to ensure that the scanner reads only the bar code you intend to scan.
3. Scan the appropriate digits from the [Keypad](#) in [Appendix C](#) that represent the desired duration. The selectable range is 1-255, which is the duration in 10-millisecond increments. Pad all single and double digit numbers with leading zeroes to yield a three-digit entry (001-255).

Examples:

005 = 50ms

040 = 400ms

250 = 2,500ms (2.5 seconds)

4. The scanner will automatically exit Programming Mode when the appropriate amount of digits have been scanned.



Set EAS Deactivation Duration — Retry

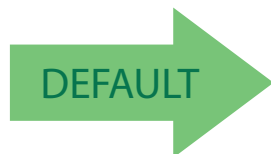

Default setting for this feature is:
050 -500ms

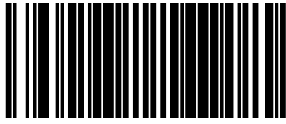

EAS Deactivation Duration — Exception

Specifies the amount of time EAS deactivation is operative upon pushing the EAS Exception Button.



This setting pertains only to units configured for EAS Coupled Mode. Reference the [EAS Mode](#) description for more information about Coupled and Decoupled EAS operation. Also reference [EAS Retry Count](#).

NOTE

To set the EAS Deactivation Duration — Exception:

1. Scan the Enter/Exit Programming Mode bar code.
2. Scan the bar code, [Set EAS Deactivation Duration — Exception](#) below. You'll need to cover any unused bar codes on this and the facing page to ensure that the scanner reads only the bar code you intend to scan.
3. Scan the appropriate digits from the [Keypad in Appendix C](#) that represent the desired duration. The selectable range is 1-255, which is the duration in 10-millisecond increments. Pad all single and double digit numbers with leading zeroes to yield a three-digit entry (001-255).

Examples:

005 = 50ms

040 = 400ms

250 = 2,500ms (2.5 seconds)

4. The scanner will automatically exit Programming Mode when the appropriate amount of digits have been scanned.



Set EAS Deactivation Duration — Exception



Default setting for this feature is:
100 - 1 Second



EAS Pre-Read Time

This feature specifies the time duration that must elapse before reading a label once an EAS tag is sensed.

To set this feature:

1. Scan the Enter/Exit Programming Mode bar code.
2. Scan the bar code, [Set EAS Pre-Read Time](#) below. You'll need to cover any unused bar codes on this and the facing page to ensure that the scanner reads only the bar code you intend to scan.
3. Scan the appropriate digits from the [Keypad in Appendix C](#) that represent the desired duration. The selectable range is 000-255, which is the duration in 10-millisecond increments. Pad all single and double digit numbers with leading zeroes to yield a three-digit entry (000-255).

Examples:

005 = 50ms

040 = 400ms

250 = 2,500ms (2.5 seconds)

4. The scanner will automatically exit Programming Mode when the appropriate amount of digits have been scanned.



Set EAS Pre-Read Time

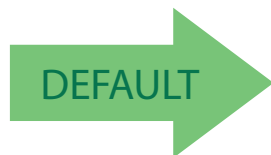

Default setting for this feature is:

025 = 250ms

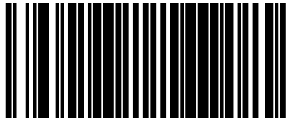

EAS Features — Checkpoint

The features in this section apply only to Checkpoint® EAS systems. See [EAS Features — Sensormatic on page 147](#) to set options for that system.

ERI Active State

Specifies the active state polarity of ERI; the inactive state is its opposite polarity. ERI output goes active during the good read of a bar code, allowing the EAS device to deactivate a tag on the product.

To set the ERI Active State:

1. Scan the Enter/Exit Programming Mode bar code.
2. Scan your selection from the bar codes below. You'll need to cover any unused bar codes on this and the facing page to ensure that the scanner reads only the bar code you intend to scan.
3. Complete the programming sequence by scanning the Enter/Exit Programming Mode bar code.



ERI Active State = Active Low



ERI Active State = Active High



ERI Timeout

Specifies the amount of time that an ERI signal is held in its active state for a good read.

To set the ERI Timeout:

1. Scan the Enter/Exit Programming Mode bar code.
2. Scan the bar code, [Set ERI Timeout](#) below. You'll need to cover any unused bar codes on this and the facing page to ensure that the scanner reads only the bar code you intend to scan.
3. Scan the appropriate digits from the [Keypad in Appendix C](#) that represent the desired duration. The selectable range is 1-255, which is the duration in 10-millisecond increments. Pad all single and double digit numbers with leading zeros to yield a three-digit entry (001-255).

Examples:

000 = ERI timeout disabled

001 = 10ms

005 = 50ms

040 = 400ms

250 = 2,500ms (2.5 seconds)



A setting of 0 (000) disables this feature.

NOTE

4. The scanner will automatically exit Programming Mode when the appropriate amount of digits have been scanned.



Set ERI Timeout

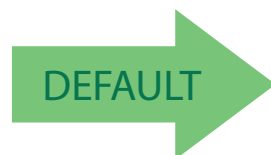

Default setting for this feature is:
002 -20ms

NOTES

Chapter 11

Interface Related Features

Interface Type

Specifies the current scanner interface. Selections are:

INTERFACE (I/F) TYPE	I/F I.D. NUMBER^a
RS-232 Standard	05
RS-232 Wincor-Nixdorf	12
RS-232 Single Cable	20
USB OEM	45
IBM Port 17	04
IBM Port 5B	08
IBM Port 9B	23
USB Keyboard	35
USB-TEC	0D
USB COM	47

NOT USER-SELECTABLE	
System Interface	7-segment FRU display indicates 0 at start-up (accompanied by trill beep for approx. 2 seconds)

- a. To access a scanner's interface identification number, place the scanner in Scanner Diagnostic Mode and view the 7-segment FRU display (reference [Chapter 2, Diagnostic Modes](#), for more information).



NOTE

A new scanner may have been shipped from the factory with a Null Interface (no interface type selected) to ensure system compatibility at installation. In this case, the correct Interface Type programming bar code must be scanned first before the scanner can be used with a POS system.



NOTE

If the scanner's interface type must be changed, always be sure that interface configuration is the FIRST item scanned during a programming session. (Selecting an interface type resets ALL other configuration items to the factory default for that interface type.)

To select the desired interface:



CAUTION

Great care should be taken to select the correct interface type, since you can cause damage to the scanner and/or POS terminal by attempting to change to an incompatible interface. ALWAYS make interface selections with the host cable DISCONNECTED.



NOTE

When an interface is selected, the scanner loads the configuration for that interface as the selection is made. Any custom configurations done in the previous interface will not be carried over to the configuration for the new interface.

1. Disconnect current interface cable(s) if currently connected.
2. Scan the Enter/Exit Programming Mode bar code.
3. Scan the bar code representing the appropriate interface located on the following pages. You'll need to cover any unused bar codes adjacent to and on any facing pages to ensure the scanner reads only the bar code you intend to scan.
4. Complete the programming sequence by scanning the Enter/Exit Programming Mode bar code.



NOTE

Once the correct interface has been set, it will be necessary to proceed to the appropriate pages in this manual that select parameters and options for that interface. For example, if RS-232 is selected, turn to the pages in this manual headed as features specific to the RS-232 interface.

5. Connect new interface cable(s).



RS-232 Interface Selection

Remember to cover any unused bar codes on this and the facing page to ensure that the scanner reads only the bar code you intend to scan.



CAUTION

Great care should be taken to select the correct interface type, since you can cause damage to the scanner and/or POS terminal by attempting to change to an incompatible interface. ALWAYS make interface selections with the host cable DISCONNECTED.



Interface Type = RS-232 Standard



Interface Type = RS-232 Wincor-Nixdorf



NOTE

Single cable installations require connection at the POS Terminal (host) port. The Scale Host port connection is not used for this interface.



Interface Type = RS-232 Single Cable

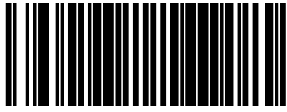

USB Interface Selection

Remember to cover any unused bar codes on this and the facing page to ensure that the scanner reads only the bar code you intend to scan.



CAUTION

Great care should be taken to select the correct interface type, since you can cause damage to the scanner and/or POS terminal by attempting to change to an incompatible interface. ALWAYS make interface selections with the host cable DISCONNECTED.



NOTE

Single cable installations require connection at the POS Terminal (host) port. The Scale Host port connection is not used for this interface.



Interface Type = USB OEM



Interface Type = USB TEC



Interface Type = USB COM



IBM Interface Selection

Remember to cover any unused bar codes on this and the facing page to ensure that the scanner reads only the bar code you intend to scan.



CAUTION

Great care should be taken to select the correct interface type, since you can cause damage to the scanner and/or POS terminal by attempting to change to an incompatible interface. ALWAYS make interface selections with the host cable DISCONNECTED.



NOTE

Single cable installations require connection at the POS Terminal (host) port. The Scale Host port connection is not used for this interface.



Interface Type = IBM Port 17

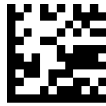

Interface Type = IBM Port 5B



Interface Type = IBM 4683 Port 9B

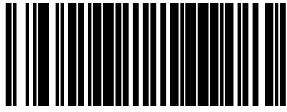

Enter/Exit Programming Mode

Keyboard Interface Selection

Remember to cover any unused bar codes on this and the facing page to ensure that the scanner reads only the bar code you intend to scan.



CAUTION

Great care should be taken to select the correct interface type, since you can cause damage to the scanner and/or POS terminal by attempting to change to an incompatible interface. ALWAYS make interface selections with the host cable DISCONNECTED.



Interface Type = USB Keyboard



Maximum Host-Transmitted Message Length

Specifies the maximum number of data characters allowed in messages transmitted to the host.

To set the Maximum Host-Transmitted Message Length:

1. Scan the Enter/Exit Programming Mode bar code.
2. Scan the bar code, [Set Maximum Host-Transmitted Message Length](#) below. You'll need to cover any unused bar codes on this and the facing page to ensure that the scanner reads only the bar code you intend to scan.
3. Scan the appropriate digits from the [Keypad](#) in [Appendix C](#) that represent the desired maximum host-transmitted message length. The selectable range is 0-249 data characters. (Labels that are longer than this length are not read.) Pad all single and double digit numbers with leading zeroes to yield a three-digit entry (000-249).



If this configuration item is set to 0 (000), there is no general length limit imposed on data being transmitted to the host.

NOTE

4. The scanner will automatically exit Programming Mode when the appropriate amount of digits have been scanned.



Set Maximum Host-Transmitted Message Length

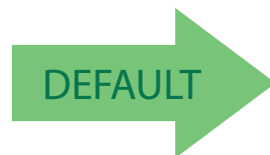

Default setting for this feature is:
000 - No general limit imposed

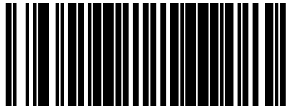

IBM Features

IBM Interface Options

IBM interfaces offer specific control over interaction with certain devices.



The USB OEM interface provides its own set of options. Refer to the feature, USB OEM Interface Options, in this section.

NOTE

Options for this feature are as follows:

- FULL host interface support — Accepts scanner and scale configuration host commands.
- Ignore host interface configuration of scanner and scale — Ignores all scanner and scale configuration host commands.

To set this feature:

1. Scan the Enter/Exit Programming Mode bar code.
2. Scan your selection from the bar codes below. You'll need to cover any unused bar codes on this and the facing page to ensure that the scanner reads only the bar code you intend to scan.
3. Complete the programming sequence by scanning the Enter/Exit Programming Mode bar code.



IBM Interface Option = Full Host Interface Support



IBM Interface Option = Ignore Host I/F Config of Scanner & Scale



IBM Scale Address



This feature applies to IBM Port 17 ONLY.

NOTE

Specifies IBM scale address for IBM Port 17. The following three addresses are available:

- 6A
- 6B
- 6E

To set the IBM Scale Address:

1. Scan the Enter/Exit Programming Mode bar code.
2. Scan the bar code below that represents the desired scale address designation.
3. Complete the programming sequence by scanning the Enter/Exit Programming Mode bar code.



IBM Scale Address = 6A



IBM Scale Address = 6b

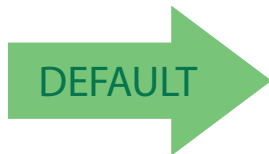

IBM Scale Address = 6E



IBM Transmit Labels in Code 39 Format

This feature enables/disables scanner's ability to set a symbology identifier for a specified label to Code 39 before transmitting that label data to an IBM host. This applies to: Code 128, Code 93 and Codabar for IBM Port 5B; Code 93 and Codabar for IBM Port 9B; Code 128, Code 93 and Codabar for OEM-USB.



When enabled, this feature has no effect on IBM Port 17.

NOTE

To enable/disable the IBM Transmit Labels in Code 39 Format feature:

1. Scan the Enter/Exit Programming Mode bar code.
2. Scan either the enable or disable bar code below. You'll need to cover any unused bar codes on this and the facing page to ensure that the scanner reads only the bar code you intend to scan.
3. Complete the programming sequence by scanning the Enter/Exit Programming Mode bar code.

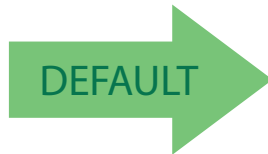

IBM Transmit Labels in Code 39 Format = Disable



IBM Transmit Labels in Code 39 Format = Enable



46XX Number of Host Resets

This setting specifies the number of consecutive resets before entering label Programming Mode to allow scanner configuration.

To set this feature:

1. Scan the Enter/Exit Programming Mode bar code.
2. Scan the bar code, [Set 46XX Number of Host Resets](#) below. You'll need to cover any unused bar codes on this and the facing page to ensure that the scanner reads only the bar code you intend to scan.
3. Scan the appropriate digits from the [Keypad](#) in [Appendix C](#) that represent the desired number of resets. The selectable range is 01-15 data characters. Pad all single digit numbers with a leading zero to yield a two-digit entry (01-15).
4. Scan the Enter/Exit Programming Mode bar code to exit Programming Mode.



Set 46XX Number of Host Resets

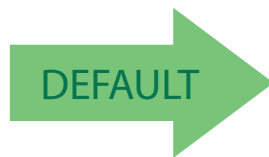

Default setting for this feature is: 06 (six resets)

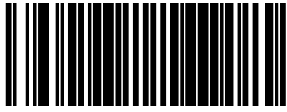

46XX Label Slicing Control

This feature enables slicing of IBM 46XX host data into multiple pieces when a label is longer than the length specified by the feature [46XX Maximum Label Slice Length](#).

To set this feature:

1. Scan the ENTER/EXIT Programming Mode bar code.
2. Scan your selection from the barcodes below. You'll need to cover any unused barcodes on this and the facing page to ensure that the scanner reads only the barcode you intend to scan.
3. Complete the programming sequence by scanning the ENTER/EXIT Programming Mode bar code.



46XX Label Slicing Control = Send Data in One Piece



46XX Label Slicing Control = Slice Data Into Multiple Pieces if Necessary





46XX Maximum Label Slice Length

This feature specifies the maximum allowable length of host transmitted data in each sdlc frame.



This setting only applies when 46XX Label Slicing Control is enabled.

NOTE

To set this feature:

1. Scan the Enter/Exit Programming Mode bar code.
2. Scan the bar code, [Set 46XX Maximum Label Slice Length](#). You'll need to cover any unused bar codes on this and the facing page to ensure that the scanner reads only the bar code you intend to scan.
3. Scan the appropriate digits from the keypad in [Appendix C](#) that represent the desired length setting. The selectable range is 001-246 (a setting of 000 indicates no length limitation). Pad all single and double digit numbers with leading zeroes to yield a three-digit entry (001-246).
4. Complete the programming sequence by scanning the ENTER/EXIT Programming Mode bar code.



Set 46XX Maximum Label Slice Length

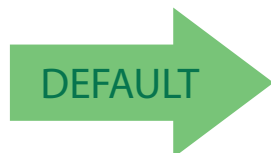

Default setting for this feature is:
040 - 64 Characters



USB OEM Interface Options

The OEM-USB interface offers specific control over interaction with certain devices. Options for this feature are as follows:

- FULL host interface support — Accepts scanner and scale configuration host commands.
- Compatible with Magellan SL host interface support — Uses Magellan SL host interface support.
- Ignore host interface configuration of scanner and scale — Ignores all scanner and scale configuration host commands.



This feature applies only to the USB OEM interface. For other IBM interfaces, refer to the feature, IBM Interface Options, earlier in this section.

NOTE

To set this feature:

1. Scan the Enter/Exit Programming Mode bar code.
2. Scan your selection from the bar codes below. You'll need to cover any unused bar codes on this and the facing page to ensure that the scanner reads only the bar code you intend to scan.
3. Complete the programming sequence by scanning the Enter/Exit Programming Mode bar code.



USB OEM Interface Options = Full Interface Support



USB OEM Interface Options = Compatible with Magellan SL Host Interface Support



USB OEM Interface Options = Ignore Host Interface Configuration of Scanner and Scale



USB OEM Scanner Device Type

The OEM-USB protocol allows for the scanner to be identified as one of two different types of bar code scanners. Depending on what other scanners you may already have connected to a USB POS, you may need to change this setting to enable all scanners to communicate. Options are:

- Table Top Scanner
- Handheld Scanner

To set this feature:

1. Scan the Enter/Exit Programming Mode bar code.
2. Scan your selection from the bar codes below. You'll need to cover any unused bar codes on this and the facing page to ensure that the scanner reads only the bar code you intend to scan.
3. Complete the programming sequence by scanning the Enter/Exit Programming Mode bar code.

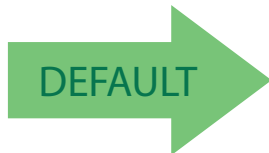

USB OEM Scanner Device Type = Table Top Scanner



USB OEM Scanner Device Type = Handheld Scanner

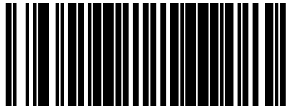

RS-232 Features

RS-232 Baud Rate

This feature selects the baud rate required for sending and receiving data.



Single cable interfaces are limited to Baud Rate selections up to 19200. They cannot communicate at Baud Rates of 38400 and up.

NOTE

To specify the RS-232 Baud Rate:

1. Scan the Enter/Exit Programming Mode bar code.
2. Scan the desired baud rate from the bar codes below and on the immediately following pages. You'll need to cover any unused bar codes on this and the facing page to ensure that the scanner reads only the bar code you intend to scan.
3. Complete the programming sequence by scanning the Enter/Exit Programming Mode bar code.



RS-232 Baud Rate = 1200



RS-232 Baud Rate = 2400



RS-232 Baud Rate = 4800



RS-232 Baud Rate = 9600



RS-232 Baud Rate = 19200



RS-232 Baud Rate (continued)



RS-232 Baud Rate = 38400



RS-232 Baud Rate = 57600



RS-232 Baud Rate = 115200



RS-232 Baud Rate = 230400



RS-232 Baud Rate = 460800



RS-232 Baud Rate = 921600



Enter/Exit Programming Mode

RS-232 Number of Data Bits

Specifies number of data bits required for sending and receiving data.

To set this feature:

1. Scan the Enter/Exit Programming Mode bar code.
2. Scan the bar code below representing the desired Data Bit setting. You'll need to cover any unused bar codes on this and the facing page to ensure that the scanner reads only the bar code you intend to scan.
3. Complete the programming sequence by scanning the Enter/Exit Programming Mode bar code.



RS-232 Number of Data Bits = 7



RS-232 Number of Data Bits = 8





RS-232 Number of Stop Bits

Specifies number of stop bits required for sending and receiving data.

To set this feature:

1. Scan the Enter/Exit Programming Mode bar code.
2. Scan the bar code below representing the desired Stop Bit setting. You'll need to cover any unused bar codes on this and the facing page to ensure that the scanner reads only the bar code you intend to scan.
3. Complete the programming sequence by scanning the Enter/Exit Programming Mode bar code.

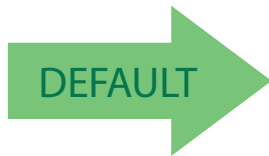

RS-232 Number of Stop Bits = 1



RS-232 Number of Stop Bits = 2

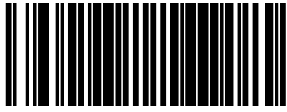

RS-232 Parity

Specifies parity required for sending and receiving data.

Options for this setting are:

- RS-232 PARITY = NONE
- RS-232 PARITY = EVEN
- RS-232 PARITY = ODD

To set this feature:

1. Scan the Enter/Exit Programming Mode bar code.
2. Scan the bar code below or on the following pages representing the desired Parity setting. You'll need to cover any unused bar codes, as well as facing pages to ensure that the scanner reads only the bar code you intend to scan.
3. Complete the programming sequence by scanning the Enter/Exit Programming Mode bar code.

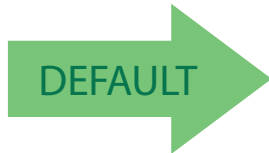

RS-232 Parity = None



RS-232 Parity = Even



RS-232 Parity = Odd



RS-232 Hardware Control

Enables/disables use of the RS-232 CTS signal for flow control and/or scan control.

Options are:

- Disable — The scanner transmits to the host regardless of any activity on the CTS line.
- Enable CTS Flow Control — The CTS signal controls transmission of data to the host.
- Enable CTS Scan Control — The CTS line must be active for scanner to read and transmit data. While the CTS line is inactive, scanner remains in a host-disabled state; following a successful label transmission, the CTS signal must transition to inactive and then to active to enable scanning for the next label.
- Enable Magellan SL CTS Scan Control — Follows the same hardware protocol as older Magellan SL scanners.

To set this feature:

1. Scan the Enter/Exit Programming Mode bar code.
2. Scan bar code below or from the following page for the desired setting. You'll need to cover any unused bar codes on facing pages to ensure that the scanner reads only the bar code you intend to scan.
3. Complete the programming sequence by scanning the Enter/Exit Programming Mode bar code.



RS-232 Hardware Control = Disable



RS-232 Hardware Control = Enable CTS Flow Control



RS-232 Parity = Enable CTS Scan Control



RS-232 Hardware Control = Enable MGL SL CTS Scan Control



RS-232 Intercharacter Delay

Specifies delay between the end of one character and the beginning of the next in 10-millisecond increments.

To set the RS-232 Intercharacter Delay:

1. Scan the Enter/Exit Programming Mode bar code.
2. Scan the bar code below, [Set RS-232 Intercharacter Delay](#). You'll need to cover any unused bar codes on this and the facing page to ensure that the scanner reads only the bar code you intend to scan.
3. Scan the appropriate digits from the [Keypad](#) in [Appendix C](#) that represent the desired delay. The selectable range is 0-100, which is the delay in 10-millisecond increments. Pad all single and double digit numbers with leading zeroes to yield a three-digit entry (000-100).

Examples:

001 = 10ms

005 = 50ms

040 = 400ms

100 = 1,000ms (1 second)

4. The scanner will automatically exit Programming Mode when the appropriate amount of digits have been scanned.



Set RS-232 Intercharacter Delay



Default setting for this feature is:
00 - No Intercharacter Delay



RS-232 Software Flow Control

Enables/disables RS-232 Flow Control using XON/ XOFF characters.



This item will be ignored when the feature, RS-232 NAK Character, is enabled

NOTE

To set this feature:

1. Scan the Enter/Exit Programming Mode bar code.
2. Scan either the enable or disable bar code below. You'll need to cover any unused bar codes on this and the facing page to ensure that the scanner reads only the bar code you intend to scan.
3. Complete the programming sequence by scanning the Enter/Exit Programming Mode bar code.

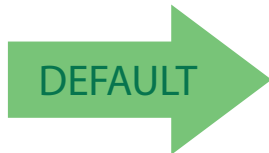

RS-232 Software Flow Control= Disable

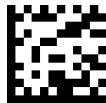

RS-232 Software Flow Control= Enable

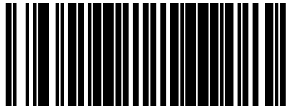

RS-232 Ignore Host Commands

When set to ignore host commands, the scanner will ignore all host commands except for the minimum set necessary to keep the interface active, transmit labels, and transmit scale information. For normal operation of the interface, disable this feature.

To set this feature:

1. Scan the Enter/Exit Programming Mode bar code.
2. Scan your selection from the bar codes below. You'll need to cover any unused bar codes on this and the facing page to ensure that the scanner reads only the bar code you intend to scan.
3. Complete the programming sequence by scanning the Enter/Exit Programming Mode bar code.



RS-232 Ignore Host Commands = Don't Ignore



RS-232 Ignore Host Commands = Ignore





RS-232 TTL

Specifies whether RS-232 interface provides TTL levels on the output pins TxD and RTS.

Choices are:

- Normal RS-232 levels
- TTL levels

To set this feature:

1. Scan the Enter/Exit Programming Mode bar code.
2. Scan the bar code below which represents the desired setting for this feature. You'll need to cover any unused bar codes on this and the facing page to ensure that the scanner reads only the bar code you intend to scan.
3. Complete the programming sequence by scanning the Enter/Exit Programming Mode bar code.

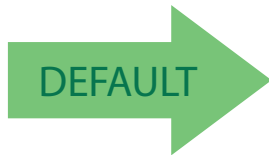

RS-232 TTL = Normal RS-232 levels



RS-232 TTL = TTL Levels



RS-232 TTL Invert

Enables/disables inversion of TTL.

To set this feature:

1. Scan the Enter/Exit Programming Mode bar code.
2. Scan the bar code below which represents the desired setting for this feature. You'll need to cover any unused bar codes on this and the facing page to ensure that the scanner reads only the bar code you intend to scan.
3. Complete the programming sequence by scanning the Enter/Exit Programming Mode bar code.

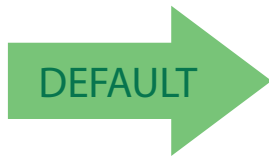

RS-232 TTL Invert = Disable



RS-232 TTL Invert = Enable



RS-232 Beep on ASCII BEL

Enables/disables ability of scanner to beep (sound a good read tone) on receiving an ASCII BEL (07 hex).

- Disable
- Enable

To enable/disable this feature:

1. Scan the Enter/Exit Programming Mode bar code.
2. Scan either the enable or disable bar code below. You'll need to cover any unused bar codes on this and the facing page to ensure that the scanner reads only the bar code you intend to scan.
3. Complete the programming sequence by scanning the Enter/Exit Programming Mode bar code.

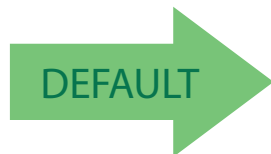

RS-232 Beep on ASCII BEL = Disable



RS-232 Beep on ASCII BEL = Enable

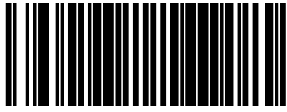

RS-232 Beep After Weigh

Enables/disables the ability of the scanner to beep after weight data is transmitted to the host. Scale interfaces that support this item are: RS-232 ICL, RS-232 SASI, and RS-232 Single Cable.

To enable/disable the Beep After Weigh feature:

1. Scan the Enter/Exit Programming Mode bar code.
2. Scan either the enable or disable bar code below. You'll need to cover any unused bar codes on this and the facing page to ensure that the scanner reads only the bar code you intend to scan.
3. Complete the programming sequence by scanning the Enter/Exit Programming Mode bar code.

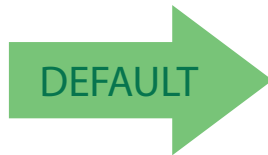

RS-232 Beep After Weigh = Disable



RS-232 Beep After Weigh = Enable



Beep on Not on File

Select for the host to beep (or not) when a not-on-file condition is detected by the host. This feature is also applicable to single cable RS-232.

Options for this feature are:

- Muted (no beep will sound)
- Low Volume
- Medium Volume
- High Volume

To configure this feature:

1. Scan the Enter/Exit Programming Mode bar code.
2. Scan the bar code for the desired selection below. You'll need to cover any unused bar codes on this and the facing page to ensure that the scanner reads only the bar code you intend to scan.
3. Complete the programming sequence by scanning the Enter/Exit Programming Mode bar code.



RS-232 Beep on Not on File = Muted



RS-232 Beep on Not on File = Low Volume



RS-232 Beep on Not on File = Medium Volume



RS-232 Beep on Not on File = High Volume

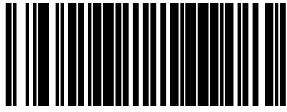

RS-232 ACK NAK Enable

This enables/disables the ability of the scanner to support the RS-232 ACK/NAK protocol. When configured, the scanner and/or host sends an “ACK” when it receives data properly, and sends “NAK” when the data is in error. Selections for this option are:

- Disable ACK NAK
- Enable for Label Transmission — the scanner expects an ACK/NAK response from the host when a label is sent)
- Enable for Host Acknowledgement — Enabled for Host Commands (the scanner will respond with ACK/NAK when the host sends a command)
- Enable for Label & Host — Enabled for both Label Transmission & Host Command acknowledgement.

To select the option for RS-232 ACK NAK Enable:

1. Scan the Enter/Exit Programming Mode bar code.
2. Scan the desired option from bar codes below and on the following page. You’ll need to cover any unused bar codes on this and the facing page to ensure that the scanner reads only the bar code you intend to scan.
3. Complete the programming sequence by scanning the Enter/Exit Programming Mode bar code.

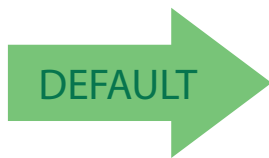

RS-232 ACK NAK = Disable



RS-232 ACK NAK = Enable for Label Transmission



RS-232 ACK NAK = Enable for Host Acknowledgement



RS-232 ACK NAK = Enable for Label & Host



RS-232 ACK Character

This feature specifies which ASCII character will be used as an ACK character.



DO NOT set this feature to use previously defined characters such as XON, XOFF or host commands as this will conflict with normal operation of these characters. 8-bit data is not recognized when the feature, RS-232 Number of Data Bits, is set to 7 data bits.

NOTE

To specify the RS-232 ACK Character:

1. Scan the Enter/Exit Programming Mode bar code.
2. Scan the bar code, SET RS-232 ACK Character below. You'll need to cover any unused bar codes on this and the facing page to ensure the scanner reads only the bar code you intend to scan.
3. Scan the appropriate digits from the [Keypad](#) in [Appendix C](#) that represent the hex designation for the desired character. A table containing the ASCII Character Set and their corresponding Hex Values is available in the inside back cover of this manual. ASCII parameters must be input by scanning a pair of hexadecimal digits for the desired character. For example, if ASCII "A" were the desired ACK character, you would scan the digits "4", then "1" (the ASCII corresponding hex value).
4. The scanner will automatically exit Programming Mode when the appropriate amount of digits/characters have been scanned.



Set RS-232 ACK Character

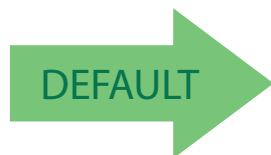

Default setting for this feature is:
06 - ACK



RS-232 NAK Character

This feature specifies which ASCII character will be used as a NAK character.



DO NOT set this feature to use previously defined characters such as XON, XOFF or host commands as this will conflict with normal operation of these characters. 8-bit data is not recognized when the feature, RS-232 Number of Data Bits, is set to 7 data bits.

NOTE

To specify the RS-232 NAK Character:

1. Scan the Enter/Exit Programming Mode bar code.
2. Scan the bar code, SET RS-232 NAK Character below. You'll need to cover any unused bar codes on this and the facing page to ensure the scanner reads only the bar code you intend to scan.
3. Scan the appropriate digits from the the [Keypad](#) in [Appendix C](#) that represent the hex designation for the desired character. A table containing the ASCII Character Set and their corresponding Hex Values is available in the inside back cover of this manual. ASCII parameters must be input by scanning a pair of hexadecimal digits for the desired character. For example, if ASCII "A" were the desired NAK character, you would scan the digits "4", then "1" (the ASCII corresponding hex value).
4. The scanner will automatically exit Programming Mode when the appropriate amount of digits/characters have been scanned.



Set RS-232 NAK Character



Default setting for this feature is:
15 - NAK



RS-232 Retry on ACK NAK Timeout

This option specifies the action scanner performs on expiration of the RS-232 ACK NAK Timeout Value.

Options are:

- Disable (transmission failure occurs)
- Enable (retry)

To set this feature:

1. Scan the Enter/Exit Programming Mode bar code.
2. Scan either the enable or disable bar code below. You'll need to cover any unused bar codes on this and the facing page to ensure that the scanner reads only the bar code you intend to scan.
3. Complete the programming sequence by scanning the Enter/Exit Programming Mode bar code.



RS-232 Retry on ACK NAK Timeout = Disable

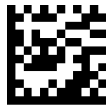

RS-232 Retry on ACK NAK Timeout = Enable





RS-232 ACK NAK Timeout Value

This item specifies the time the scanner will wait for an ACK character from the host following a label transmission.

- 0 = Infinite timeout
- 1 - 75 = Timeout in 200-millisecond increments

To set the ACK NAK Timeout Value:

1. Scan the Enter/Exit Programming Mode bar code.
2. Scan the bar code below, [Set RS-232 ACK NAK Timeout Value](#). You'll need to cover any unused bar codes on this and the facing page to ensure that the scanner reads only the bar code you intend to scan.
3. Scan the appropriate digits from the [Keypad](#) in [Appendix C](#) that represent the desired timeout. A setting of 0 specifies an infinite timeout. The remaining selectable range is 1-75, which is the timeout in 200-millisecond increments. Pad all single digit numbers with a leading zero to yield a two-digit entry (00-75).

Examples:

00 = Infinite timeout

01 = 200ms

05 = 1,000ms (1 second)

40 = 8,000ms (8 seconds)

75 = 15,000ms (15 seconds)

The scanner will automatically exit Programming Mode when the appropriate amount of digits have been scanned.



Set RS-232 ACK NAK Timeout Value

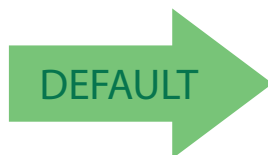

Default setting for this feature is:
01 - 200ms



RS-232 ACK NAK Retry Count

This feature sets the number of times for the scanner to retry a label transmission under a retry condition.

To set the RS-232 ACK NAK Retry Count:

1. Scan the Enter/Exit Programming Mode bar code.
2. Scan the bar code, [Set RS-232 ACK NAK Retry Count](#) below. You'll need to cover any unused bar codes on this and the facing page to ensure that the scanner reads only the bar code you intend to scan.
3. Scan the appropriate digits from the [Keypad](#) in [Appendix C](#) that represent the desired number. The selectable range is 000-255 resets. Pad all single and double digit numbers with leading zeroes to yield a three-digit entry (000-255).



A setting of 255 specifies "retry forever."

NOTE

4. The scanner will automatically exit Programming Mode when the appropriate amount of digits have been scanned.



Set RS-232 ACK NAK Retry Count

Default setting for this feature is:
003 - Three retrys

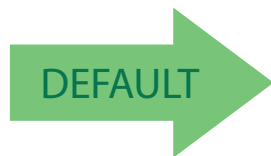

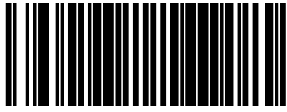

RS-232 ACK NAK Error Handling

This item specifies the method the scanner will use to handle errors detected while waiting to receive the ACK character from the host. Errors include unrecognized host commands and communication errors such as parity or framing errors.

- Ignore Errors (recommended setting)
- Assume ACK (risk of lost label data)
- Assume NAK (risk of duplicate label)

To select the option for RS-232 ACK NAK Error Handling:

1. Scan the Enter/Exit Programming Mode bar code.
2. Scan the desired option from the bar codes below. You'll need to cover any unused bar codes on this and the facing page to ensure that the scanner reads only the bar code you intend to scan.
3. Complete the programming sequence by scanning the Enter/Exit Programming Mode bar code.

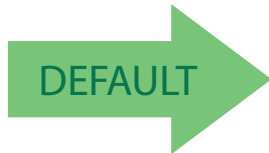

RS-232 ACK NAK Error Handling = Ignore Errors



RS-232 ACK NAK Error Handling = Assume ACK



RS-232 ACK NAK Error Handling = Assume NAK



RS-232 Indicate Transmission Failure

This feature enables / disables the ability of the scanner to sound a bad label beep indication when a transmission failure occurs.

To set this feature:

1. Scan the Enter/Exit Programming Mode bar code.
2. Scan the desired option from the bar codes below. You'll need to cover any unused bar codes on this and the facing page to ensure that the scanner reads only the bar code you intend to scan.
3. Complete the programming sequence by scanning the Enter/Exit Programming Mode bar code.



RS-232 Indicate Transmission Failure = Disable



RS-232 Indicate Transmission Failure = Enable



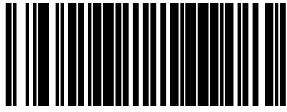

Single Cable RS-232 Options

The RS-232 Single Cable interface shares some configuration options with other RS-232 interfaces. Rather than repeat them in this section as Single Cable options, please find them referenced as follows:

[RS-232 Baud Rate on page 178](#)

[RS-232 Number of Data Bits on page 180](#)

[RS-232 Number of Stop Bits on page 181](#)

[RS-232 Parity on page 182](#)

[RS-232 Software Flow Control on page 185](#)

[RS-232 Beep After Weigh on page 190](#)

[Beep on Not on File on page 191](#)



Single Cable RS-232 Scanner Only Protocol

This sets the type of interface protocol that will be used in Single Cable RS-232.

Options are:

- Scanner/scale RS-232 protocol
- Scanner only RS-232 protocol

To set this feature:

1. Scan the Enter/Exit Programming Mode bar code.
2. Scan the bar code below representing the desired option. You'll need to cover any unused bar codes on this and the facing page to ensure that the scanner reads only the bar code you intend to scan.
3. Complete the programming sequence by scanning the Enter/Exit Programming Mode bar code.

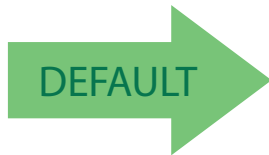

Single Cable RS-232 Scanner Only Protocol = Scanner/
scale RS-232 protocol



Single Cable RS-232 Scanner Only Protocol = Scanner
Only protocol



Single Cable RS-232 RTS CTS Selection

Specifies how RTS and CTS are used to control the data flow. RTS is controlled by the Scanner and can be continuously held high/low, or can be asserted during label transmission. The scanner looks at CTS, as the configuration values state, to determine when to send label data.

Choices are:

- Option 0 = RTS is held in low state and CTS is ignored
- Option 1 = RTS is held in high state and CTS is ignored
- Option 2 = Assert RTS and wait for CTS to be asserted
- Option 3 = Assert RTS and ignore CTS
- Option 4 = RTS held low, wait for CTS to be asserted
- Option 5 = RTS held high, wait for CTS to be asserted

To set this feature:

1. Scan the Enter/Exit Programming Mode bar code.
2. Scan a bar code below or on the following pages representing the desired option. You'll need to cover any unused bar codes, as well as facing pages to ensure that the scanner reads only the bar code you intend to scan.
3. Complete the programming sequence by scanning the Enter/Exit Programming Mode bar code.



Single Cable RS-232 RTS CTS Selection = Option 0



Single Cable RS-232 RTS CTS Selection = Option 1



Single Cable RS-232 RTS CTS Selection = Option 2



Single Cable RS-232 RTS CTS Selection = Option 3



Single Cable RS-232 RTS CTS Selection (continued)



Single Cable RS-232 RTS CTS Selection = Option 4



Single Cable RS-232 RTS CTS Selection = Option 5





Enter/Exit Programming Mode

Single Cable RS-232 Use BCC

Enables/disables the ability of the scanner to use BCC (Block Check Character).

To set this feature:

1. Scan the Enter/Exit Programming Mode bar code.
2. Scan either the enable or disable bar code below. You'll need to cover any unused bar codes on this and the facing page to ensure that the scanner reads only the bar code you intend to scan.
3. Complete the programming sequence by scanning the Enter/Exit Programming Mode bar code.

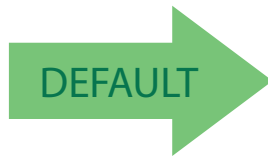

Single Cable RS-232 Use BCC = Disable

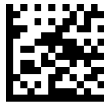

Single Cable RS-232 Use BCC = Enable



Single Cable RS-232 Use ACK/NAK

Enables/disables the ability of the scanner to use ACK/NAK.

To set this feature:

1. Scan the Enter/Exit Programming Mode bar code.
2. Scan either the enable or disable bar code below. You'll need to cover any unused bar codes on this and the facing page to ensure that the scanner reads only the bar code you intend to scan.
3. Complete the programming sequence by scanning the Enter/Exit Programming Mode bar code.

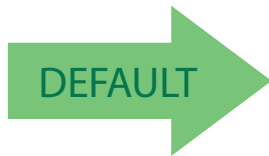

Single Cable RS-232 Use ACK/NAK = Disable



Single Cable RS-232 Use ACK/NAK = Enable

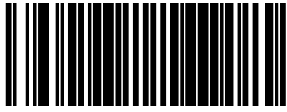

Enter/Exit Programming Mode

Single Cable RS-232 Use STX

Enables/disables the ability of the scanner to use STX.

To set this feature:

1. Scan the Enter/Exit Programming Mode bar code.
2. Scan either the enable or disable bar code below. You'll need to cover any unused bar codes on this and the facing page to ensure that the scanner reads only the bar code you intend to scan.
3. Complete the programming sequence by scanning the Enter/Exit Programming Mode bar code.



Single Cable RS-232 Use STX = Disable



Single Cable RS-232 Use STX = Enable





Set Single Cable RS-232 STX Character

This feature selects the STX character.

To specify the STX Character:

1. Scan the Enter/Exit Programming Mode bar code.
2. Scan the bar code, [Set Single Cable RS-232 STX Character](#) below. You'll need to cover any unused bar codes on this and the facing page to ensure the scanner reads only the bar code you intend to scan.
3. Scan the appropriate characters/digits from the [Keypad in Appendix C](#) that represent the decimal designation for the desired character. A table containing the ASCII Character Set and their corresponding decimal values is available in the inside back cover of this manual. ASCII parameters must be input by scanning decimal digits for each character. Pad all numbers with leading zeroes to yield a three-digit entry (001-127). Thus, to set a single character value of A, bar codes containing the digits '0', '6' and '5' must be scanned. The selectable range for this option is any decimal value from 001 to 127.
4. The scanner will automatically exit Programming Mode when the appropriate amount of digits have been scanned.



Set Single Cable RS-232 STX Character

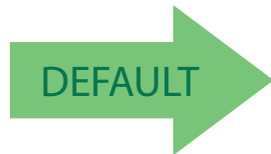

Default setting for this feature is:
053 - S

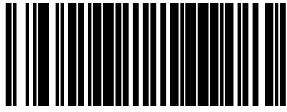

Enter/Exit Programming Mode

Single Cable RS-232 Use ETX

Enables/disables the ability of the scanner to use ETX.

To set this feature:

1. Scan the Enter/Exit Programming Mode bar code.
2. Scan either the enable or disable bar code below. You'll need to cover any unused bar codes on this and the facing page to ensure that the scanner reads only the bar code you intend to scan.
3. Complete the programming sequence by scanning the Enter/Exit Programming Mode bar code.



Single Cable RS-232 Use ETX = Disable



Single Cable RS-232 Use ETX = Enable





Set Single Cable RS-232 ETX Character

Allows selection of the ETX character.

To specify the ETX Character:

1. Scan the Enter/Exit Programming Mode bar code.
2. Scan the bar code, [Set Single Cable RS-232 ETX Character](#) below. You'll need to cover any unused bar codes on this and the facing page to ensure the scanner reads only the bar code you intend to scan.
3. Scan the appropriate characters/digits from the [Keypad in Appendix C](#) that represent the decimal designation for the desired character. A table containing the ASCII Character Set and their corresponding decimal values is available in the inside back cover of this manual. ASCII parameters must be input by scanning decimal digits for each character. Pad all numbers with leading zeroes to yield a three-digit entry (001-127). Thus, to set a single character value of A, bar codes containing the digits '0', '6' and '5' must be scanned. The selectable range for this option is any decimal value from 001 to 127.
4. The scanner will automatically exit Programming Mode when the appropriate amount of digits have been scanned.



Set Single Cable RS-232 ETX Character

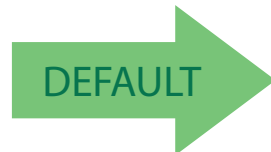

Default setting for this feature is:
00D - CR

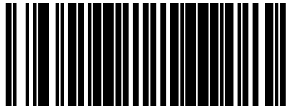

Enter/Exit Programming Mode

Single Cable RS-232 Datalogic Extensions

When Datalogic extensions are enabled, scale calibration mode information is communicated to the host. Contact Customer Support for the format of this information. Choices for this feature are:

- Standard Protocol
- Support Datalogic Extensions to Protocol

To set this feature:

1. Scan the Enter/Exit Programming Mode bar code.
2. Scan your selection from the bar codes below. You'll need to cover any unused bar codes on this and the facing page to ensure that the scanner reads only the bar code you intend to scan.
3. Complete the programming sequence by scanning the Enter/Exit Programming Mode bar code.

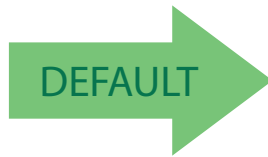

Single Cable RS-232 Datalogic Extensions = Standard Protocol



Single Cable RS-232 Datalogic Extensions = Support Datalogic Extensions to Protocol



Single Cable RS-232 Pacesetter Plus

This option enables the scanner's ability to send Pacesetter Plus information as trailers to UPC/EAN bar codes.

To set this feature:

1. Scan the Enter/Exit Programming Mode bar code.
2. Scan your selection from the bar codes below. You'll need to cover any unused bar codes on this and the facing page to ensure that the scanner reads only the bar code you intend to scan.
3. Complete the programming sequence by scanning the Enter/Exit Programming Mode bar code.

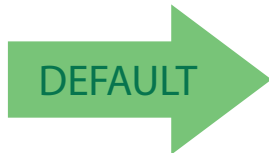

Single Cable RS-232 Pacesetter Plus = Do Not Send



Single Cable RS-232 Pacesetter Plus = Send



USB Keyboard and Keyboard Wedge Features

USB Keyboard and Keyboard Wedge Intercharacter Delay

Specifies a time delay between characters.

To set this feature:

1. Scan the [USB Keyboard and Keyboard Wedge Intercharacter Delay](#) bar code.
2. Scan the appropriate characters/digits from the [Keypad](#) in [Appendix C](#) that represent the desired delay. The selectable range for this option is any decimal value from 00 (no delay) to 99 in 10 ms increments. A table containing the ASCII Character Set and their corresponding decimal values is available in the inside back cover of this manual. ASCII parameters must be input by scanning decimal digits for each character. Pad all single digit numbers with leading zero to yield a two-digit entry (00-99). Thus, to set an intercharacter delay of 70ms, bar codes containing the digits '0' and '7' must be scanned.
3. Complete the programming sequence by scanning the Enter/Exit Programming Mode bar code.



Set USB Keyboard/Keyboard Wedge Intercharacter Delay

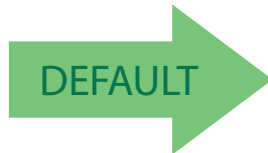

Default setting for this feature is: 01 (10ms)



Keyboard Wedge No Keyboard Support

Enables the scanner to perform host communications normally performed by an attached keyboard.

To set this feature:

1. Scan the Enter/Exit Programming Mode bar code.
2. Scan either the enable or disable bar code below. You'll need to cover any unused bar codes on this and the facing page to ensure that the scanner reads only the bar code you intend to scan.
3. Complete the programming sequence by scanning the Enter/Exit Programming Mode bar code.

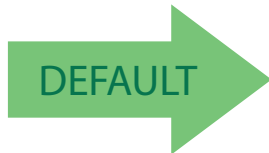

Keyboard Wedge No Keyboard Support = Disable



Keyboard Wedge No Keyboard Support = Enable



USB Keyboard and Keyboard Wedge Send Control Characters

This feature specifies how the scanner transmits ASCII control characters to the host.



Affects suffix and prefix characters. When disabled, only ASCII characters between 20H and 127H inclusive (space... delete) plus special characters 0DH (carriage return), 08H (backspace), 27H (ESC), 09H (right tab) and 0BH (left tab) are transmitted.

NOTE

Choices are:

Disable — No control characters are sent to the host.

Enable transmission of control characters to host — Control characters are sent to the host.

Send characters between 00H and 1FH — Send characters between 00H and 1FH according to special function-key mapping table (This is used to send keys that are not in normal ASCII set; a unique set is provided for each available scancode set)

To set this feature:

1. Scan the Enter/Exit Programming Mode bar code.
2. Scan the bar code for the desired setting below. You'll need to cover any unused bar codes on this and the facing page to ensure that the scanner reads only the bar code you intend to scan.
3. Complete the programming sequence by scanning the Enter/Exit Programming Mode bar code.

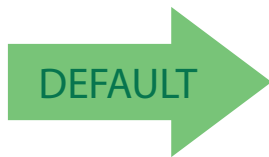

Keyboard Send Control Characters = Disable



Keyboard Send Control Characters =
Enable transmission of control characters to host



USB Keyboard/Keybd Wedge No Keyboard Support =
Send characters between 00H and 1FH



USB Keyboard and Keyboard Wedge Country Mode

This feature specifies the country/language that will be supported by the keyboard.

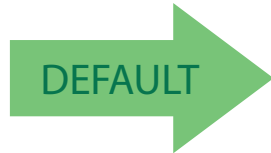

USB Keyboard and Keyboard Wedge Country Mode =
USA



USB Keyboard and Keyboard Wedge Country Mode = Bel-
gium



USB Keyboard and Keyboard Wedge Country Mode =
Britain



USB Keyboard and Keyboard Wedge Country Mode =
Denmark



USB Keyboard and Keyboard Wedge Country Mode =
France



USB Keyboard and Keyboard Wedge Country Mode = Ger-
many

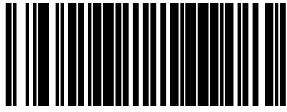

Enter/Exit Programming Mode

USB Keyboard and Keyboard Wedge Country Mode (continued)



USB Keyboard and Keyboard Wedge Country Mode =
Italy



USB Keyboard and Keyboard Wedge Country Mode =
Norway



USB Keyboard and Keyboard Wedge Country Mode =
Portugal



USB Keyboard and Keyboard Wedge Country Mode =
Spain



USB Keyboard and Keyboard Wedge Country Mode =
Sweden



USB Keyboard and Keyboard Wedge Country Mode =
Switzerland



USB Keyboard and Keyboard Wedge Country Mode (continued)



USB Keyboard and Keyboard Wedge Country Mode =
Japanese 106-key



USB Keyboard and Keyboard Wedge Country Mode =
Hungary



USB Keyboard and Keyboard Wedge Country Mode =
Czech Republic



USB Keyboard and Keyboard Wedge Country Mode = Slo-
vakia



USB Keyboard and Keyboard Wedge Country Mode =
Romania



USB Keyboard and Keyboard Wedge Country Mode =
Croatia



USB Keyboard and Keyboard Wedge Country Mode =
Poland

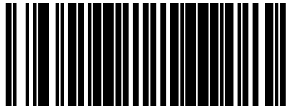

Enter/Exit Programming Mode

USB Keyboard and Keyboard Wedge Country Mode (continued)



USB Keyboard and Keyboard Wedge Country Mode =
French Canadian



USB Keyboard and Keyboard Wedge Country Mode =
Turkish



Keyboard Wedge Quiet Interval

This setting specifies the amount of time to monitor for keyboard activity before breaking the keyboard connection.

To set this feature:

1. Scan the Enter/Exit Programming Mode bar code.
2. Scan the bar code, [Keyboard Wedge Quiet Interval](#). You'll need to cover any unused bar codes on this and the facing page to ensure that the scanner reads only the bar code you intend to scan.
3. Scan the appropriate digits from the [Keypad](#) in [Appendix C](#) that represent the desired time interval. The selectable range is 001-100, which is the interval in 10-millisecond increments. Pad all single and double digit numbers with leading zeroes to yield a three-digit entry (001-100).

Examples:

001 = 10ms

005 = 50ms

040 = 400ms

100 = 1,000ms (1 second)

4. The scanner will automatically exit Programming Mode when the appropriate amount of digits have been scanned.



Set Keyboard Wedge Quiet Interval

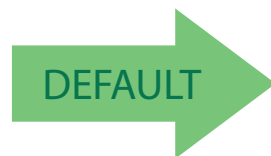

Default setting for this feature is:
00A - 100ms



USB Keyboard and Keyboard Wedge Caps Lock State

This feature specifies the format in which the scanner sends character data. Selections are:

Caps Lock OFF — Send character data in normal format

Caps Lock ON — Send character data in reverse case

Shift Lock Mode — Send character data in shifted case. This only applies to Wedge G. For other interfaces, this setting results in a Caps Lock OFF functionality.

Caps Lock Compensation Mode — This only applies to USB Keyboard. For other interfaces, this setting results in a Caps Lock OFF functionality.

To set this feature:

1. Scan the Enter/Exit Programming Mode bar code.
2. Scan the desired selection from the bar codes below. You'll need to cover any unused bar codes on this and the facing page to ensure that the scanner reads only the bar code you intend to scan.
3. Complete the programming sequence by scanning the Enter/Exit Programming Mode bar code.

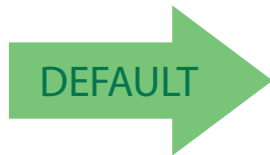

USB Keyboard and Keyboard Wedge Caps Lock State =
Caps Lock OFF



USB Keyboard and Keyboard Wedge Caps Lock State =
Caps Lock ON



USB Keyboard and Keyboard Wedge Caps Lock State =
Shift Lock Mode

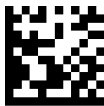

USB Keyboard and Keyboard Wedge Caps Lock State =
Caps Lock Comensation

Chapter 12

Data Editing

Data Editing Overview



These features are not supported by the USB-OEM interface.

CAUTION

When a bar code is scanned, additional information can be sent to the host computer along with the bar code data. This combination of bar code data and supplementary user-defined data is called a “message string.” The features in this chapter can be used to build specific user-defined data into a message string.

There are several types of selectable data characters that can be sent before and after scanned data. You can specify if they should be sent with all symbologies, or only with specific symbologies. [Figure 56](#) shows the available elements you can add to a message string.

Figure 56. Breakdown of a Message String

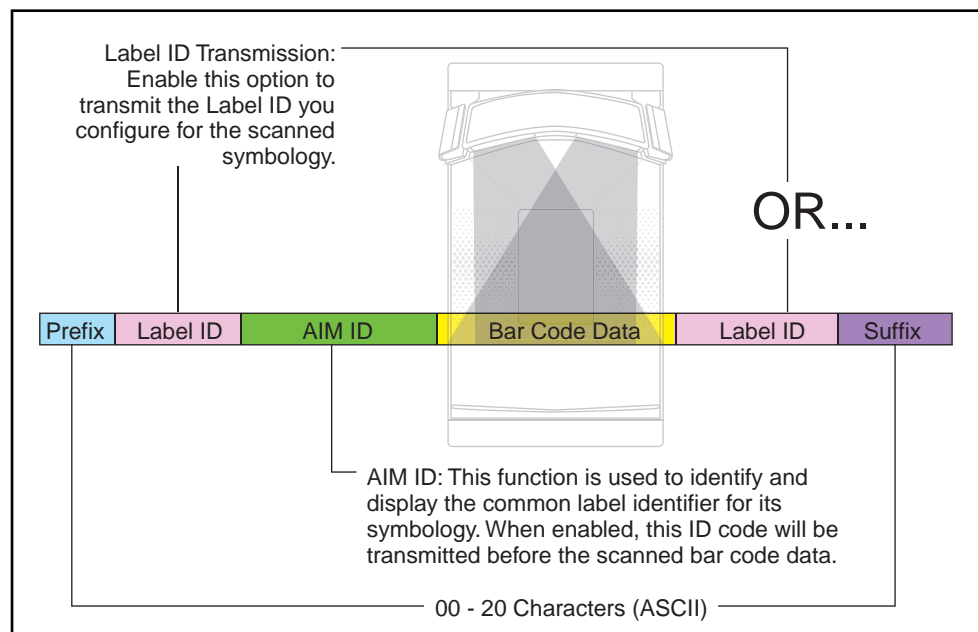

Additional data editing options include the features [Case Conversion](#) and [Character Conversion](#).

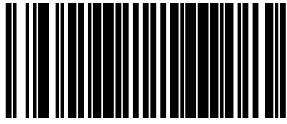

Please Keep In Mind...

- Modifying a message string is not a mandatory requirement. Data editing is a sophisticated feature allowing highly customizable output for advanced users. Factory default settings for data editing is typically set to NONE.
- A prefix or suffix may be applied (reference the [1D Symbology Programming](#) or [2D Symbology Programming](#) chapter for these settings) across all symbologies (set via the Global features in this chapter).
- You can add any character from the [ASCII Character Set](#) (from 00-7F) on the inside back cover of this manual as a prefix, suffix or Label ID.
- Enter prefixes and suffixes in the order in which you want them to appear on the output.

Case Conversion

This option can change the case of all alphabetic characters to upper or lower case.

To set this feature:

1. Scan the Enter/Exit Programming Mode bar code.
2. Scan bar code for the desired option below. You'll need to cover any unused bar codes on this and the facing page to ensure that the scanner reads only the bar code you intend to scan.
3. Complete the programming sequence by scanning the Enter/Exit Programming Mode bar code.

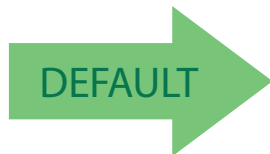

Case Conversion = No Case Conversion



Case Conversion = Upper Case



Case Conversion = Lower Case



Character Conversion

Character conversion is an eight byte configuration item. The eight bytes are 4 character pairs represented in hexadecimal ASCII values. The first character in the pair is the character that will be converted. The second character in the pair is the character to convert to. If the character to convert in a pair is FF, then no conversion is done.

For example, if you have the character conversion configuration item set to the following:

41423132FFFFFFFF

The first pair is 4142 or AB (41 hex is an ASCII capital A, 42 hex is an ASCII capital B) and the second pair is 3132 or 12 (31 hex is an ASCII 1, 32 is an ASCII 2). The other two pairs are FFFF and FFFF.

With the label, AG15TA81, it would look as follows after the character conversion:
BG25TB82.

The A characters were converted to the B character and the 1 characters were converted to the numeral 2 character. Nothing is done with the last two character pairs, since they are all FF.

To set Character Conversion:

1. Scan the Enter/Exit Programming Mode bar code.
2. Scan the Character Conversion bar code.
3. Determine the desired string. Up to sixteen positions can be determined as in the above example. Next, turn to the ASCII Chart on the inside back cover of this manual and find the equivalent hex digits needed to fulfill the string.



NOTE

The positions not used must be filled with the character 'F'!

4. Turn to the [Keypad](#) in [Appendix C](#) and scan the bar codes representing the hex characters determined in the previous step. When the last character is scanned, the scanner will sound a triple beep.
5. Complete the programming sequence by scanning the Enter/Exit Programming Mode bar code.



Set Character Conversion

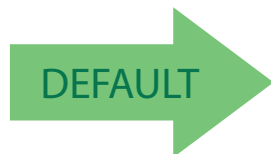

Default setting for this feature is:
FFFFFFFFFFFFFFFF (No Character Conversion)

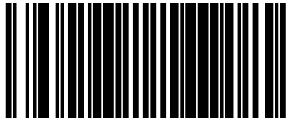

Global Prefix

This feature applies to RS-232 interfaces (Standard, Wincor-Nixdorf, and Single Cable). It specifies the prefix that is added to beginning of label transmission.

To specify the Global Prefix Character(s):

1. Scan the Enter/Exit Programming Mode bar code.
2. Scan the bar code, [Set Global Prefix](#) below. You'll need to cover any unused bar codes to ensure the scanner reads only the bar code you intend to scan.
3. Scan the appropriate characters/digits from the [Keypad](#) in [Appendix C](#) that represent the hex designation for the desired character(s). A table containing the ASCII Character Set and their corresponding Hex Values is available in the inside back cover of this manual. ASCII parameters must be input by scanning a pair of hexadecimal digits for each character. Thus, to set a two-character value of AB, bar codes containing the digits '4', '1', '4', and '2' must be scanned. The selectable range for this option is any hex value from 00 to FF. Up to 20 hex pairs can be designated.



To specify "no Global Prefix," scan 00.

NOTE

4. If designating the full 20 hex pairs, the scanner will automatically exit Programming Mode when the appropriate amount of digits have been scanned. If designating less than 20 hex pairs, you can end the programming sequence early by scanning the [Terminate Sequence](#) bar code.
5. Complete the programming sequence by scanning the Enter/Exit Programming Mode bar code.



Set Global Prefix



Terminate Sequence

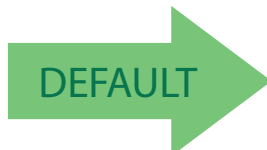

Default setting for this feature is:
00 - No Global Prefix



Global Suffix

This feature applies to RS-232 interfaces (Standard, Wincor-Nixdorf, and Single Cable). It specifies the suffix that is added to end of a label transmission. Three standard options are available below. Contact your dealer for other alternate settings for this feature.

- No Global Suffix
- CR — Carriage Return
- CR LF — Carriage Return, Line Feed

To set the Global Suffix:

1. Scan the Enter/Exit Programming Mode bar code.
2. Scan your selection from the bar codes below.
3. Complete the programming sequence by scanning the Enter/Exit Programming Mode bar code.



Global Suffix = No Global Suffix



Global Suffix = CR



Global Suffix = CR LF

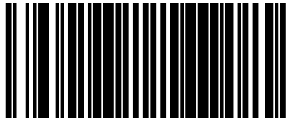

Enter/Exit Programming Mode

Global AIM ID Enable

This option enables or disables the addition of the AIM ID to all bar code types except for EAN 128.

To set this option:

1. Scan the Enter/Exit Programming Mode bar code.
2. Scan either the enable or disable bar code below. You'll need to cover any unused bar codes on this and the facing page to ensure that the scanner reads only the bar code you intend to scan.
3. Complete the programming sequence by scanning the Enter/Exit Programming Mode bar code.

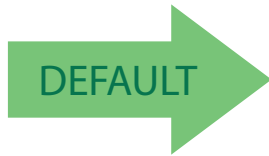

Global AIM ID = Disable



Global AIM ID = Enable



Label ID Control

This feature specifies whether or not Label IDs are transmitted to the host and if so, whether to attach them as a prefix or suffix.

Choices are:

- Disable
- Enable as a Prefix
- Enable as a Suffix

To select the option for Label ID Control:

1. Scan the Enter/Exit Programming Mode bar code.
2. Scan the desired option from the bar codes below. You'll need to cover any unused bar codes on this and the facing page to ensure that the scanner reads only the bar code you intend to scan.
3. Complete the programming sequence by scanning the Enter/Exit Programming Mode bar code.



Label ID Control = Disable



Label ID Control = Enable as a Prefix



Label ID Control = Enable as a Suffix

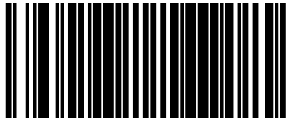

Label ID

This feature allows the setting of custom Label ID character(s) for each available symbology type if other than the default Label ID is desired.

To set this feature:

1. Scan the Enter/Exit Programming Mode bar code.
2. Scan the bar code for the desired symbology below. You'll need to cover any unused bar codes on this and the facing page to ensure the scanner reads only the bar code you intend to scan.
3. Scan the appropriate digits from the [Keypad](#) in [Appendix C](#) that represent the desired Label ID characters; entered as two hex pairs. A table containing the ASCII Character Set and their corresponding Hex Values is available in the inside back cover of this manual. ASCII parameters must be input by scanning a pair of hexadecimal digits for each character. Thus, to set a two-character value of AB, bar codes containing the digits '4', '1', '4', and '2' must be scanned. The selectable range for this option is any hex value from 00 to FF.

Complete the programming sequence by scanning the Enter/Exit Programming Mode bar code.

1D Symbologies

Default Label ID for this symbology is:
41 = A



Set UPC-A Label ID



Set UPC-A 2-Digit Supplemental Label ID

Default Label ID for this symbology is:
41 = A



Set UPC-A 5-Digit Supplemental Label ID



Set UPC-E Label ID

Default Label ID for this symbology is:
45 = E



Label ID (continued)

Default Label ID for this symbology is:
45 = E



Set UPC-E 2-Digit Supplemental Label ID



Set UPC-E 5-Digit Supplemental Label ID

Default Label ID for this symbology is:
45 = E



Set EAN-13 Label ID

Default Label ID for this symbology is:
46 = F



Set EAN-13 2-Digit Supplemental Label ID

Default Label ID for this symbology is:
46 = F



Set EAN-13 5-Digit Supplemental Label ID

Default Label ID for this symbology is:
46 = F



Set EAN-8 Label ID

Default Label ID for this symbology is:
4646 = FF



Set EAN-8 2-Digit Supplemental Label ID

Default Label ID for this symbology is:
4646 = FF

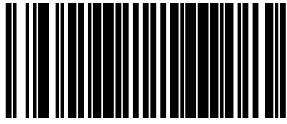

Enter/Exit Programming Mode

Label ID (continued)



Set EAN-8 5-Digit Supplemental Label ID

Default Label ID for this symbology is:
4646 = FF

Default Label ID for this symbology is:
47 = G



Set GTIN Label ID



Set GTIN 2-Digit Supplemental Label ID

Default Label ID for this symbology is:
4732 = G2

Default Label ID for this symbology is:
4735 = G5



Set GTIN 5-Digit Supplemental Label ID



Set GTIN Code 128 Supplemental Label ID

Default Label ID for this symbology is:
4738 = G8

Default Label ID for this symbology is:
5234 = R4



Set DataBar Omnidirectional Label ID



Set DataBar Omnidirectional Composite Label ID

Default Label ID for this symbology is:
5234 = R4



Label ID (continued)

Default Label ID for this symbology is:
5258 = RX



Set DataBar Expanded Label ID

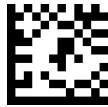

Set DataBar Expanded Composite Label ID

Default Label ID for this symbology is:
5258 = RX

Default Label ID for this symbology is:
2A = *



Code 39 Label ID



Code 32 Label ID

Default Label ID for this symbology is:
41 = A

Default Label ID for this symbology is:
23 = #



Code 128 Label ID



EAN 128 Label ID

Default Label ID for this symbology is:
50 = P

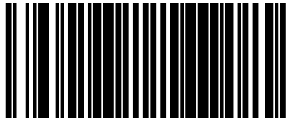

Enter/Exit Programming Mode

Label ID (continued)

Default Label ID for this symbology is:
69 = i



12 of 5 Label ID



Codabar Label ID

Default Label ID for this symbology is:
25 = %



Code 93 Label ID

Default Label ID for this symbology is:
26 = &



MSI Label ID

Default Label ID for this symbology is:
40 = @



Standard 2 of 5 Label ID

Default Label ID for this symbology is:
73 = s



ISBN Label ID

Default Label ID for this symbology is:
49 = l



2D Symbologies

Default Label ID for this symbology is:
446D = Dm



Data Matrix Label ID



PDF 417 Label ID

Default Label ID for this symbology is:
50 = P



Micro PDF 417 Label ID

Default Label ID for this symbology is:
6D50 = mP



QR Code Label ID

Default Label ID for this symbology is:
5152 = QR



Micro QR Code Label ID

Default Label ID for this symbology is:
2451 = \$Q



Aztec Label ID

Default Label ID for this symbology is:
417A = Az

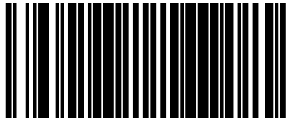

Global Mid-Label ID

This feature specifies a global mid-label ID that is added between two bar codes for transmission.

To set this feature:

1. Scan the Enter/Exit Programming Mode bar code.
2. Scan the [Set Global Mid-Label ID](#) bar code below. You'll need to cover any unused bar codes on this and the facing page to ensure the scanner reads only the bar code you intend to scan.
3. Scan the appropriate digits from the [Keypad](#) in [Appendix C](#) that represent the desired mid-label ID characters; entered as two hex pairs. A table containing the ASCII Character Set and their corresponding Hex Values is available in the inside back cover of this manual. ASCII parameters must be input by scanning a pair of hexadecimal digits for each character. Thus, to set a two-character value of AB, bar codes containing the digits '4', '1', '4', and '2' must be scanned. The selectable range for this option is any hex value from 00 to FF.

Complete the programming sequence by scanning the Enter/Exit Programming Mode bar code.



Set Global Mid-Label ID

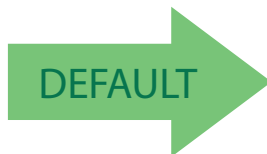

Default Label ID for this symbology is:
00 = No Global Mid-label ID

Chapter 13

1D Symbology Programming

1D Symbologies



NOTE

If the scanner's interface type must be changed, always be sure that interface configuration is the **FIRST** item scanned during a programming session. (Selecting an interface type resets **ALL** other configuration items — including symbology programming — to the factory default for that interface type.)

The following pages contain configuration information concerning the various bar code types (symbologies) the scanner supports.

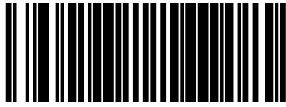

Coupon Control

This feature is used to control the method of processing coupon labels. For the purposes of this feature, coupon labels are defined as:

1. UPC-A labels that start with a '5'
2. GS1 DataBar Expanded labels that start with '8110'

The options for this setting are:

- Disable — Coupon Control is turned off.
- Enable UPC-A Coupons — UPC-A coupon labels will decode but GS1 DataBar Expanded coupon labels will not. GS1 DataBar Expanded labels that are not coupon labels will decode and all UPC-A labels will decode.
- Enable GS1 DataBar Expanded Coupons — GS1 DataBar Expanded coupon labels will decode but UPC-A coupon labels will not. UPC-A labels that are not coupon labels will decode and all GS1 DataBar Expanded labels will decode.

To set this feature:

1. Scan the Enter/Exit Programming Mode bar code.
2. Scan your choice from the Coupon Control selections below. You'll need to cover any unused bar codes on this and the facing page to ensure that the scanner reads only the bar code you intend to scan.
3. Complete the programming sequence by scanning the Enter/Exit Programming Mode bar code.



Coupon Control = Disable



Coupon Control = Enable UPC-A Coupons



Coupon Control = Enable GS1 DataBar Expanded Coupons



UPC-A Enable

Enables/disables the ability of the scanner to decode UPC-A labels.

To set this feature:

1. Scan the Enter/Exit Programming Mode bar code.
2. Scan either the enable or disable bar code below. You'll need to cover any unused bar codes on this and the facing page to ensure that the scanner reads only the bar code you intend to scan.
3. Complete the programming sequence by scanning the Enter/Exit Programming Mode bar code.



UPC-A = Disable



UPC-A = Enable





UPC-A Number System Character Transmission

Enables/disables transmission of a UPC-A number system character.



This feature MUST be enabled for IBM interfaces for proper function. This item is ignored when the advanced feature, Full Label Edit, is enabled.

NOTE

To set this feature:

1. Scan the Enter/Exit Programming Mode bar code.
2. Scan either the enable or disable bar code below. You'll need to cover any unused bar codes on this and the facing page to ensure that the scanner reads only the bar code you intend to scan.
3. Complete the programming sequence by scanning the Enter/Exit Programming Mode bar code.



UPC-A Number System Character Transmission =
Disable



UPC-A Number System Character Transmission = Enable





UPC-A Check Character Transmission

Enables/disables transmission of a UPC-A check character.



This item is ignored when the advanced feature, Full Label Edit, is enabled.

NOTE

To set this feature:

1. Scan the Enter/Exit Programming Mode bar code.
2. Scan either the enable or disable bar code below. You'll need to cover any unused bar codes on this and the facing page to ensure that the scanner reads only the bar code you intend to scan.
3. Complete the programming sequence by scanning the Enter/Exit Programming Mode bar code.



UPC-A Check Character Transmission = Disable



UPC-A Check Character Transmission = Enable





UPC-A Minimum Read

This feature specifies the minimum number of consecutive UPC-A decodes before is accepted as good read.

To set this feature:

1. Scan the ENTER/EXIT Programming Mode bar code.
2. Scan your selection from the bar codes below. You'll need to cover any unused bar codes on this and the facing page to ensure that the scanner reads only the bar code you intend to scan.
3. Complete the programming sequence by scanning the ENTER/EXIT Programming Mode bar code.

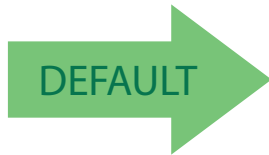

UPC-A Minimum Read = 1



UPC-A Minimum Read = 2



UPC-A Minimum Read = 3



UPC-A Minimum Read = 4



Expand UPC-A to EAN-13

Enables/disables expansion of UPC-A labels to EAN/JAN-13.

To set this feature:

1. Scan the Enter/Exit Programming Mode bar code.
2. Scan either the enable or disable bar code below. You'll need to cover any unused bar codes on this and the facing page to ensure that the scanner reads only the bar code you intend to scan.
3. Complete the programming sequence by scanning the Enter/Exit Programming Mode bar code.

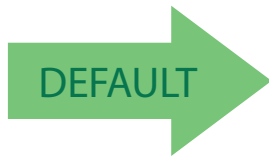

Expand UPC-A to EAN-13 = Disable



Expand UPC-A to EAN-13 = Enable

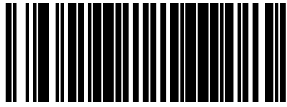

UPC-E Enable

Enables/disables the ability of the scanner to decode UPC-E labels.

To set this feature:

1. Scan the Enter/Exit Programming Mode bar code.
2. Scan either the enable or disable bar code below. You'll need to cover any unused bar codes on this and the facing page to ensure that the scanner reads only the bar code you intend to scan.
3. Complete the programming sequence by scanning the Enter/Exit Programming Mode bar code.



UPC-E = Disable



UPC-E = Enable





UPC-E Number System Character Transmission

Enables/disables transmission of a UPC-E number system character.



This item is ignored when the advanced feature, Full Label Edit, is enabled.

NOTE

To set this feature:

1. Scan the Enter/Exit Programming Mode bar code.
2. Scan either the enable or disable bar code below. You'll need to cover any unused bar codes on this and the facing page to ensure that the scanner reads only the bar code you intend to scan.
3. Complete the programming sequence by scanning the Enter/Exit Programming Mode bar code.



UPC-E Number System Character Transmission = Disable



UPC-E Number System Character Transmission = Enable



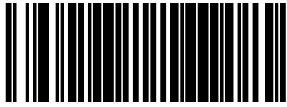

UPC-E Check Character Transmission

Enables/disables transmission of a UPC-E check character.



This item is ignored when the advanced feature, Full Label Edit, is enabled.

NOTE

To set this feature:

1. Scan the Enter/Exit Programming Mode bar code.
2. Scan either the enable or disable bar code below. You'll need to cover any unused bar codes on this and the facing page to ensure that the scanner reads only the bar code you intend to scan.
3. Complete the programming sequence by scanning the Enter/Exit Programming Mode bar code.



UPC-E Check Character Transmission = Disable



UPC-E Check Character Transmission = Enable





Expand UPC-E to UPC-A

Enables/disables expansion of UPC-E labels to UPC-A.

To set this feature:

1. Scan the Enter/Exit Programming Mode bar code.
2. Scan either the enable or disable bar code below. You'll need to cover any unused bar codes on this and the facing page to ensure that the scanner reads only the bar code you intend to scan.
3. Complete the programming sequence by scanning the Enter/Exit Programming Mode bar code.

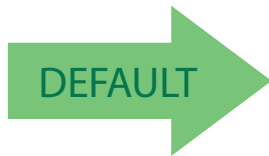

Expand UPC-E to UPC-A = Disable



Expand UPC-E to UPC-A = Enable

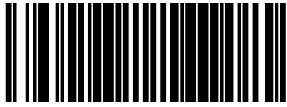

Enter/Exit Programming Mode

Expand UPC-E to EAN-13

Enables/disables expansion of UPC-E labels to EAN/JAN-13.

To set this feature:

1. Scan the Enter/Exit Programming Mode bar code.
2. Scan either the enable or disable bar code below. You'll need to cover any unused bar codes on this and the facing page to ensure that the scanner reads only the bar code you intend to scan.
3. Complete the programming sequence by scanning the Enter/Exit Programming Mode bar code.



Expand UPC-E to EAN-13 = Disable



Expand UPC-E to EAN-13 = Enable



UPC-E Minimum Read

This feature specifies the minimum number of consecutive UPC-E decodes before is accepted as good read.

To set this feature:

1. Scan the ENTER/EXIT Programming Mode bar code.
2. Scan your selection from the bar codes below. You'll need to cover any unused bar codes on this and the facing page to ensure that the scanner reads only the bar code you intend to scan.
3. Complete the programming sequence by scanning the ENTER/EXIT Programming Mode bar code.

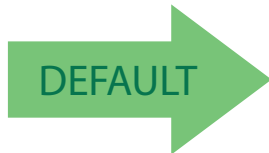

UPC-E Minimum Read = 1



UPC-E Minimum Read = 2



UPC-E Minimum Read = 3



UPC-E Minimum Read = 4



Enter/Exit Programming Mode

EAN-13 Enable

Enables/disables the ability of the scanner to decode EAN/JAN-13 labels.

To set this feature:

1. Scan the Enter/Exit Programming Mode bar code.
2. Scan either the enable or disable bar code below. You'll need to cover any unused bar codes on this and the facing page to ensure that the scanner reads only the bar code you intend to scan.
3. Complete the programming sequence by scanning the Enter/Exit Programming Mode bar code.



EAN-13 = Disable



EAN-13 = Enable





EAN-13 First Character Transmission

Enables/disables transmission of EAN/JAN-13 first character.



This item is ignored when the advanced feature, Full Label Edit, is enabled.

NOTE

To set this feature:

1. Scan the Enter/Exit Programming Mode bar code.
2. Scan either the enable or disable bar code below. You'll need to cover any unused bar codes on this and the facing page to ensure that the scanner reads only the bar code you intend to scan.
3. Complete the programming sequence by scanning the Enter/Exit Programming Mode bar code.



EAN-13 First Character Transmission = Disable



EAN-13 First Character Transmission = Enable





EAN-13 Check Character Transmission

Enables/disables transmission of an EAN/JAN-13 check character.



This item is ignored when the advanced feature, Full Label Edit, is enabled.

NOTE

To set this feature:

1. Scan the Enter/Exit Programming Mode bar code.
2. Scan either the enable or disable bar code below. You'll need to cover any unused bar codes on this and the facing page to ensure that the scanner reads only the bar code you intend to scan.
3. Complete the programming sequence by scanning the Enter/Exit Programming Mode bar code.



EAN-13 Check Character Transmission = Disable



EAN-13 Check Character Transmission = Enable





EAN-13 ISBN Conversion Enable

Enables/disables conversion of EAN/JAN-13 labels starting with 978 to Bookland ISBN labels.

To set this feature:

1. Scan the Enter/Exit Programming Mode bar code.
2. Scan either the enable or disable bar code below. You'll need to cover any unused bar codes on this and the facing page to ensure that the scanner reads only the bar code you intend to scan.
3. Complete the programming sequence by scanning the Enter/Exit Programming Mode bar code.

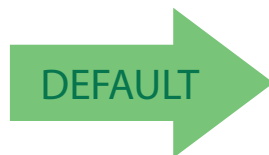

EAN-13 ISBN Conversion = Disable



EAN-13 ISBN Conversion = Enable

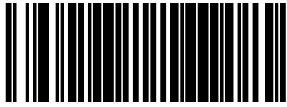

EAN-13 Minimum Read

This feature specifies the minimum number of consecutive EAN-13 decodes before is accepted as good read.

To set this feature:

1. Scan the ENTER/EXIT Programming Mode bar code.
2. Scan your selection from the bar codes below. You'll need to cover any unused bar codes on this and the facing page to ensure that the scanner reads only the bar code you intend to scan.
3. Complete the programming sequence by scanning the ENTER/EXIT Programming Mode bar code.

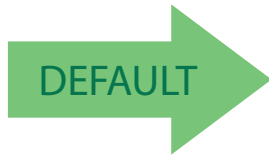

EAN-13 Minimum Read = 1

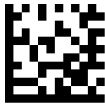

EAN-13 Minimum Read = 2



EAN-13 Minimum Read = 3



EAN-13 Minimum Read = 4



EAN-8 Enable

Enables/disables the ability of the scanner to decode EAN/JAN-8 labels.

To set this feature:

1. Scan the Enter/Exit Programming Mode bar code.
2. Scan either the enable or disable bar code below. You'll need to cover any unused bar codes on this and the facing page to ensure that the scanner reads only the bar code you intend to scan.
3. Complete the programming sequence by scanning the Enter/Exit Programming Mode bar code.



EAN-8 = Disable



EAN-8 = Enable





EAN-8 Check Character Transmission

Enables/disables transmission of an EAN/JAN-8 check character.



This item is ignored when the advanced feature, Full Label Edit, is enabled.

NOTE

To set this feature:

1. Scan the Enter/Exit Programming Mode bar code.
2. Scan either the enable or disable bar code below. You'll need to cover any unused bar codes on this and the facing page to ensure that the scanner reads only the bar code you intend to scan.
3. Complete the programming sequence by scanning the Enter/Exit Programming Mode bar code.



EAN-8 Check Character Transmission = Disable



EAN-8 Check Character Transmission = Enable





Expand EAN-8 to EAN-13

Enables/disables expansion of EAN/JAN-8 labels to EAN/JAN-13.

To set this feature:

1. Scan the Enter/Exit Programming Mode bar code.
2. Scan either the enable or disable bar code below. You'll need to cover any unused bar codes on this and the facing page to ensure that the scanner reads only the bar code you intend to scan.
3. Complete the programming sequence by scanning the Enter/Exit Programming Mode bar code.

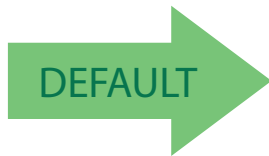

Expand EAN-8 to EAN-13 = Disable



Expand EAN-8 to EAN-13 = Enable



EAN-8 Minimum Read

This feature specifies the minimum number of consecutive EAN-8 decodes before is accepted as good read.

To set this feature:

1. Scan the ENTER/EXIT Programming Mode bar code.
2. Scan your selection from the bar codes below. You'll need to cover any unused bar codes on this and the facing page to ensure that the scanner reads only the bar code you intend to scan.
3. Complete the programming sequence by scanning the ENTER/EXIT Programming Mode bar code.

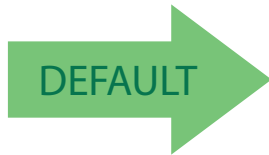

EAN-8 Minimum Read = 1



EAN-8 Minimum Read = 2



EAN-8 Minimum Read = 3



EAN-8 Minimum Read = 4



EAN-8 Guard Insertion

This setting enables the insertion of either a missing leading or trailing guard to a scanned bar code.

To set this feature:

1. Scan the Enter/Exit Programming Mode bar code.
2. Scan either the enable or disable bar code below. You'll need to cover any unused bar codes on this and the facing page to ensure that the scanner reads only the bar code you intend to scan.
3. Complete the programming sequence by scanning the Enter/Exit Programming Mode bar code.

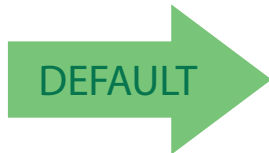

EAN-8 Guard Insertion = Disable



EAN-8 Guard Insertion = Enable

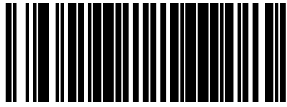

EAN-8 Guard Substitution

This setting enables the scanner to substitute a guard pattern for even-parity 6 for EAN8/JAN8 labels.

To set this feature:

1. Scan the Enter/Exit Programming Mode bar code.
2. Scan either the enable or disable bar code below. You'll need to cover any unused bar codes on this and the facing page to ensure that the scanner reads only the bar code you intend to scan.
3. Complete the programming sequence by scanning the Enter/Exit Programming Mode bar code.

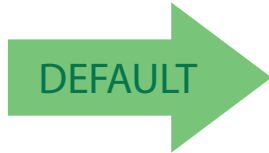

EAN-8 Guard Insertion = Disable



EAN-8 Guard Insertion = Enable



EAN-8 Stitch Exact Label Halves

This setting enables the stitching of exact EAN-8 label halves with no overlapping characters.

To set this feature:

1. Scan the Enter/Exit Programming Mode bar code.
2. Scan either the enable or disable bar code below. You'll need to cover any unused bar codes on this and the facing page to ensure that the scanner reads only the bar code you intend to scan.
3. Complete the programming sequence by scanning the Enter/Exit Programming Mode bar code.

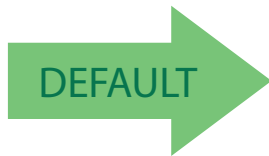

EAN-8 Stitch Exact Label Halves = Disable



EAN-8 Stitch Exact Label Halves = Enable

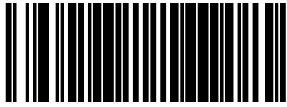

EAN-8 Stitch Unlike Label Halves

This setting enables the stitching of two EAN-8 label halves together that may have different characters.

To set this feature:

1. Scan the Enter/Exit Programming Mode bar code.
2. Scan either the enable or disable bar code below. You'll need to cover any unused bar codes on this and the facing page to ensure that the scanner reads only the bar code you intend to scan.
3. Complete the programming sequence by scanning the Enter/Exit Programming Mode bar code.

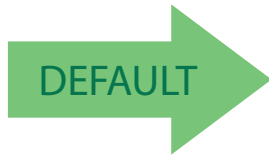

EAN-8 Stitch Unlike Label Halves = Disable

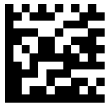

EAN-8 Stitch Unlike Label Halves = Enable



Other UPC/EAN Options

The following pages contain other selectable features for UPC/EAN symbologies:

- [In-Store Printed Label Minimum Read](#)
- [UPC/EAN Reconstruction](#)
- [UPC/EAN Correlation](#)
- [UPC/EAN Guard Insertion](#)
- [UPC/EAN Stitch Exact Label Halves](#)
- [UPC/EAN Stitch Unlike Label Halves](#)
- [UPC/EAN Minimum Segment Length](#)
- [Price Weight Check](#)
- [Enable EAN Two Label](#)
- [Addons](#)

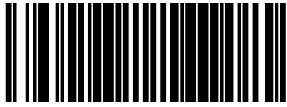

In-Store Printed Label Minimum Read

This feature specifies the minimum number of consecutive In-Store Printed Label decodes before is accepted as good read.

To set this feature:

1. Scan the ENTER/EXIT Programming Mode bar code.
2. Scan your selection from the bar codes below. You'll need to cover any unused bar codes on this and the facing page to ensure that the scanner reads only the bar code you intend to scan.
3. Complete the programming sequence by scanning the ENTER/EXIT Programming Mode bar code.

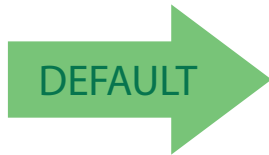

In-Store Printed Label Minimum Read = 1

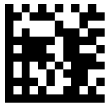

In-Store Printed Label Minimum Read = 2



In-Store Printed Label Minimum Read = 3



In-Store Printed Label Minimum Read = 4



UPC/EAN Reconstruction

Enables/disables the ability of the scanner to decode a class of UPC/EAN labels with voids. The label voids may be caused by printing defects or physical damage. This feature may be helpful in environments with in-store printed labels.



Enabling this feature increases the potential of misreads.

CAUTION

To set this feature:

1. Scan the Enter/Exit Programming Mode bar code.
2. Scan either the enable or disable bar code below. You'll need to cover any unused bar codes on this and the facing page to ensure that the scanner reads only the bar code you intend to scan.
3. Complete the programming sequence by scanning the Enter/Exit Programming Mode bar code.

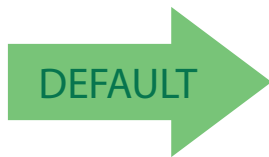

UPC/EAN Reconstruction = Disable



UPC/EAN Reconstruction = Enable



Enter/Exit Programming Mode

UPC/EAN Correlation

Enables/disables character correlation for UPC/EAN.

To set this feature:

1. Scan the ENTER/EXIT Programming Mode bar code.
2. Scan either the enable or disable barcode below. You'll need to cover any unused barcodes on this and the facing page to ensure that the scanner reads only the barcode you intend to scan.
3. Complete the programming sequence by scanning the ENTER/EXIT Programming Mode bar code.

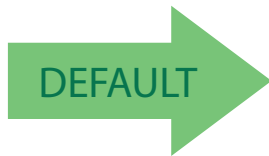

UPC/EAN Correlation = Disable



UPC/EAN Correlation = Enable



UPC/EAN Guard Insertion

This setting enables the insertion of either a missing leading or trailing guard to a scanned bar code.

To set this feature:

1. Scan the Enter/Exit Programming Mode bar code.
2. Scan either the enable or disable bar code below. You'll need to cover any unused bar codes on this and the facing page to ensure that the scanner reads only the bar code you intend to scan.
3. Complete the programming sequence by scanning the Enter/Exit Programming Mode bar code.

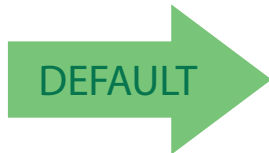

UPC/EAN Guard Insertion = Disable



UPC/EAN Guard Insertion = Enable

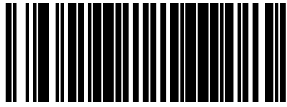

Enter/Exit Programming Mode

UPC/EAN Stitch Exact Label Halves

This setting enables the stitching of exact UPC-A/EAN-13 label halves with no overlapping characters.

To set this feature:

1. Scan the Enter/Exit Programming Mode bar code.
2. Scan either the enable or disable bar code below. You'll need to cover any unused bar codes on this and the facing page to ensure that the scanner reads only the bar code you intend to scan.
3. Complete the programming sequence by scanning the Enter/Exit Programming Mode bar code.

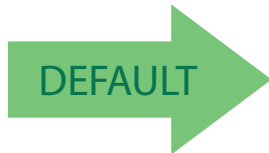

UPC/EAN Stitch Exact Label Halves = Disable



UPC/EAN Stitch Exact Label Halves = Enable



UPC/EAN Stitch Unlike Label Halves

This setting enables the stitching of two UPC-A/EAN-13 label halves together that may have different characters.

To set this feature:

1. Scan the Enter/Exit Programming Mode bar code.
2. Scan either the enable or disable bar code below. You'll need to cover any unused bar codes on this and the facing page to ensure that the scanner reads only the bar code you intend to scan.
3. Complete the programming sequence by scanning the Enter/Exit Programming Mode bar code.

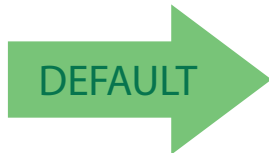

UPC/EAN Stitch Unlike Label Halves = Disable



UPC/EAN Stitch Unlike Label Halves = Enable

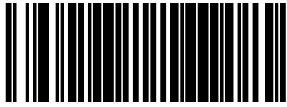

UPC/EAN Minimum Segment Length

This feature specifies the minimum number of characters needed in a UPC/EAN segment in order to be accepted for decoding.

To set this feature:

1. Scan the Enter/Exit Programming Mode bar code.
2. Scan the bar code for the desired setting below. You'll need to cover any unused bar codes on this and the facing page to ensure that the scanner reads only the bar code you intend to scan.
3. Complete the programming sequence by scanning the Enter/Exit Programming Mode bar code.

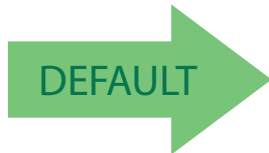

UPC/EAN Minimum Segment Length = 5 Characters



UPC/EAN Minimum Segment Length = 6 Characters



UPC/EAN Minimum Segment Length = 7 Characters



UPC/EAN Minimum Segment Length = 8 Characters



UPC/EAN Minimum Segment Length = 9 Characters



UPC/EAN Minimum Segment Length (continued)



UPC/EAN Minimum Segment Length = 10 Characters



UPC/EAN Minimum Segment Length = 11 Characters



UPC/EAN Minimum Segment Length = 12 Characters



UPC/EAN Minimum Segment Length = 13 Characters



UPC/EAN Minimum Segment Length = 14 Characters



UPC/EAN Minimum Segment Length = 15 Characters



Enter/Exit Programming Mode

Price Weight Check

Enables/disables calculation and verification of price/weight check digits. Applies to all UPC-A and EAN/JAN-13 labels with eligible¹ Number System/First Character digits.

Options are:

- Disable
- 4-digit price/weight
- 5-digit price/weight
- 4-digit European price/weight
- 5-digit European price/weight

To set this feature:

1. Scan the Enter/Exit Programming Mode bar code.
2. Scan the barcode representing the desired option below or on the following pages. You'll need to cover any unused barcodes on facing pages to ensure that the scanner reads only the barcode you intend to scan.
3. Complete the programming sequence by scanning the Enter/Exit Programming Mode bar code.

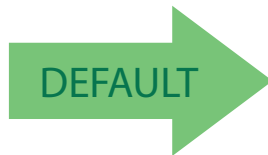

Price Weight Check = Disable



Price Weight Check = 4-digit price/weight



Price Weight Check = 5-digit price/weight

1. Price Weight Check generally applies to UPC-A labels with a Number System Digit of 2 and EAN/JAN-13 labels with a First Character of 2. There are a total of six flag digits corresponding to the six types. Checking applies depending upon which type is enabled.



Price Weight Check (continued)



Price Weight Check = 4-digit European price/weight



Price Weight Check = 5-digit European price/weight



Enter/Exit Programming Mode

Enable EAN Two Label

Enables/disables the ability of the scanner to decode EAN two-label pairs.

To set this feature:

1. Scan the Enter/Exit Programming Mode bar code.
2. Scan either the enable or disable barcode below. You'll need to cover any unused barcodes on this and the facing page to ensure that the scanner reads only the barcode you intend to scan.
3. Complete the programming sequence by scanning the Enter/Exit Programming Mode bar code.



Contact Customer Support for details about advanced programming for this feature.

NOTE

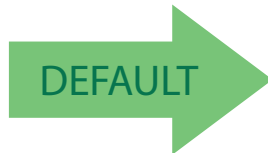

EAN Two Label = Disable



EAN Two Label = Enable



EAN Two Label Minimum Read

This feature specifies the minimum number of consecutive EAN Two Label decodes before is accepted as good read.

To set this feature:

1. Scan the ENTER/EXIT Programming Mode bar code.
2. Scan your selection from the bar codes below. You'll need to cover any unused bar codes on this and the facing page to ensure that the scanner reads only the bar code you intend to scan.
3. Complete the programming sequence by scanning the ENTER/EXIT Programming Mode bar code.

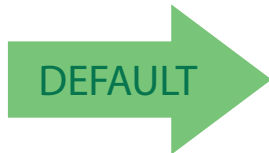

EAN Two Label Minimum Read = 1



EAN Two Label Minimum Read = 2



EAN Two Label Minimum Read = 3



EAN Two Label Minimum Read = 4



Addons

The scanner is capable of processing different types of addon codes, including:

- 2-Digit Supplemental
- 5-Digit Supplemental

Options are provided on the following pages for your convenience:

- Disable all addons — The scanner will not look for or read addons.
- Optional 2-Digit and 5-Digit Supplemental — Barcodes can be read which include 2-Digit or 5-Digit Supplementals, however, it is not required that addons be included in barcodes.



Contact customer support for advanced programming of optional and conditional addons.

NOTE

To set this feature:

1. Scan the Enter/Exit Programming Mode bar code.
2. Scan the barcode representing the desired option on this and the following page. You'll need to cover any unused barcodes on facing pages to ensure that the scanner reads only the barcode you intend to scan.
3. Complete the programming sequence by scanning the Enter/Exit Programming Mode bar code.



Addons = Disable All Addons



Addons = Optional 2-Digit and 5-Digit Supplemental



P2 Addon Minimum Read

This feature specifies the minimum number of times a P2 addon must decode before it is marked valid.

To set this feature:

1. Scan the Enter/Exit Programming Mode bar code.
2. Scan the barcode representing the desired option on this and the following page. You'll need to cover any unused barcodes on facing pages to ensure that the scanner reads only the barcode you intend to scan.
3. Complete the programming sequence by scanning the Enter/Exit Programming Mode bar code.

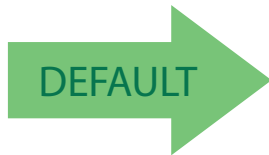

P2 Addon Minimum Read = 2



P2 Addon Minimum Read = 3



P2 Addon Minimum Read = 4



P2 Addon Minimum Read = 5



P2 Addon Minimum Read = 6

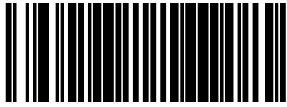

P2 Addon Minimum Read (continued)



P2 Addon Minimum Read = 7



P2 Addon Minimum Read = 8



P2 Addon Minimum Read = 9



P2 Addon Minimum Read = 10



P2 Addon Minimum Read = 11



P2 Addon Minimum Read = 12



P2 Addon Minimum Read = 13



P2 Addon Minimum Read (continued)



P2 Addon Minimum Read = 14



P2 Addon Minimum Read = 15

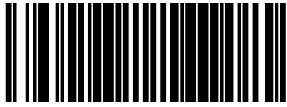

Enter/Exit Programming Mode

P5 Addon Minimum Read

This feature specifies the minimum number of times a P5 addon must decode before it is marked valid.

To set this feature:

1. Scan the Enter/Exit Programming Mode bar code.
2. Scan the barcode representing the desired option on this and the following page. You'll need to cover any unused barcodes on facing pages to ensure that the scanner reads only the barcode you intend to scan.
3. Complete the programming sequence by scanning the Enter/Exit Programming Mode bar code.



P5 Addon Minimum Read = 1



DEFAULT



P5 Addon Minimum Read = 2



P5 Addon Minimum Read = 3



P5 Addon Minimum Read = 4



P5 Addon Minimum Read = 5



P5 Addon Minimum Read = 6



P5 Addon Minimum Read (continued)



P5 Addon Minimum Read = 7



P5 Addon Minimum Read = 8



P5 Addon Minimum Read = 9



P5 Addon Minimum Read = 10



P5 Addon Minimum Read = 11



P5 Addon Minimum Read = 12



P5 Addon Minimum Read = 13



Enter/Exit Programming Mode

P5 Addon Minimum Read (continued)



P5 Addon Minimum Read = 14



P5 Addon Minimum Read = 15



GTIN Enable

Enables/Disables the ability to convert UPCE, UPCA, EAN8, and EAN13 labels into the GTIN 14-character format.



If add-on information is present on the base label prior to the conversion taking place, the add-on information will be appended to the converted GTIN barcode.

NOTE

To set this feature:

1. Scan the Enter/Exit Programming Mode bar code.
2. Scan either the enable or disable barcode below. You'll need to cover any unused bar codes on this and the facing page to ensure that the scanner reads only the bar code you intend to scan.
3. Complete the programming sequence by scanning the Enter/Exit Programming Mode bar code.

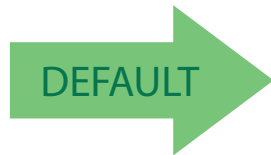

GTIN = Disable

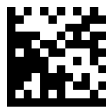

GTIN = Enable



GS1 DataBar

The symbology family, GS1 DataBar™, was formerly known as Reduced Space Symbology (RSS). For the purpose of simplicity, GS1 DataBar variants are listed in this manual as “DataBar.”

DataBar Omnidirectional Enable

Enables/disables the ability of the scanner to decode DataBar Omnidirectional labels.



This value-added feature is a factory-programmed option. Contact your dealer for information about upgrading your system to include this advanced capability.

NOTE

To set this feature:

1. Scan the ENTER/EXIT Programming Mode bar code.
2. Scan either the enable or disable barcode below. You'll need to cover any unused bar codes on this and the facing page to ensure that the scanner reads only the bar code you intend to scan.
3. Complete the programming sequence by scanning the ENTER/EXIT Programming Mode bar code.

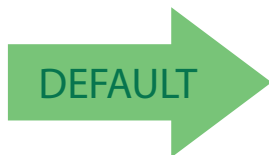

DataBar Omnidirectional = Disable



DataBar Omnidirectional = Enable



DataBar Omnidirectional/EAN-128 Emulation

Enables/disables the ability of DataBar Omnidirectional to be transmitted as EAN-128.

1. To set this feature:
2. Scan the ENTER/EXIT Programming Mode bar code.
3. Scan either the enable or disable barcode below. You'll need to cover any unused barcodes on this and the facing page to ensure that the scanner reads only the barcode you intend to scan.
4. Complete the programming sequence by scanning the ENTER/EXIT Programming Mode bar code.

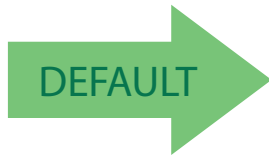

DataBar Omnidirectional/EAN-128 Emulation = Disable



DataBar Omnidirectional/EAN-128 Emulation = Enable

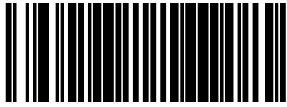

DataBar Omnidirectional 2D Component Enable

When this feature is enabled, the software will not decode an DataBar Omnidirectional barcode with a 2D component associated with it, and the 2D component will be discarded.

To set this feature:

1. Scan the ENTER/EXIT Programming Mode bar code.
2. Scan your selection from the barcodes below. You'll need to cover any unused barcodes on this and the facing page to ensure that the scanner reads only the barcode you intend to scan.
3. Complete the programming sequence by scanning the ENTER/EXIT Programming Mode bar code.

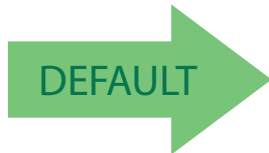

DataBar Omnidirectional 2D Component = Disable



DataBar Omnidirectional 2D Component = Enable



DataBar Omnidirectional Minimum Read

This feature specifies the minimum number of consecutive DataBar Omnidirectional decodes before is accepted as good read.

To set this feature:

1. Scan the ENTER/EXIT Programming Mode bar code.
2. Scan your selection from the bar codes below. You'll need to cover any unused bar codes on this and the facing page to ensure that the scanner reads only the bar code you intend to scan.
3. Complete the programming sequence by scanning the ENTER/EXIT Programming Mode bar code.

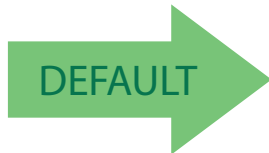

DataBar Omnidirectional Minimum Read = 1



DataBar Omnidirectional Minimum Read = 2



DataBar Omnidirectional Minimum Read = 3



DataBar Omnidirectional Minimum Read = 4

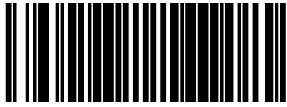

DataBar Expanded Enable

Enables/disables the ability of the scanner to decode DataBar Expanded labels.



This value-added feature is a factory-programmed option. Contact your dealer for information about upgrading your system to include this advanced capability.

NOTE

To set this feature:

1. Scan the ENTER/EXIT Programming Mode bar code.
2. Scan either the enable or disable barcode below. You'll need to cover any unused barcodes on this and the facing page to ensure that the scanner reads only the barcode you intend to scan.
3. Complete the programming sequence by scanning the ENTER/EXIT Programming Mode bar code.

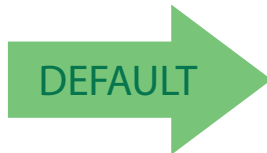

DataBar Expanded = Disable



DataBar Expanded = Enable



DataBar Expanded EAN-128 Emulation

Enables/disables EAN 128 emulation for DataBar Expanded.

To set this feature:

1. Scan the ENTER/EXIT Programming Mode bar code.
2. Scan either the enable or disable barcode below. You'll need to cover any unused barcodes on this and the facing page to ensure that the scanner reads only the barcode you intend to scan.
3. Complete the programming sequence by scanning the ENTER/EXIT Programming Mode bar code.

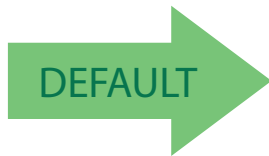

DataBar Expanded EAN-128 Emulation = Disable



DataBar Expanded EAN-128 Emulation = Enable



DataBar Expanded 2D Component Enable

When this feature is enabled, the software will not decode an DataBar Expanded barcode with a 2D component associated with it, and the 2D component will be discarded.

To set this feature:

1. Scan the ENTER/EXIT Programming Mode bar code.
2. Scan your selection from the barcodes below. You'll need to cover any unused barcodes on this and the facing page to ensure that the scanner reads only the barcode you intend to scan.
3. Complete the programming sequence by scanning the ENTER/EXIT Programming Mode bar code.

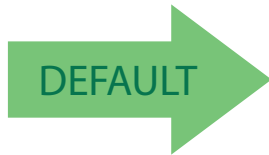

DataBar Expanded 2D Component = Disable



DataBar Expanded 2D Component = Enable



DataBar Expanded Minimum Read

This feature specifies the minimum number of consecutive DataBar Expanded decodes before is accepted as good read.

To set this feature:

1. Scan the ENTER/EXIT Programming Mode bar code.
2. Scan your selection from the bar codes below. You'll need to cover any unused bar codes on this and the facing page to ensure that the scanner reads only the bar code you intend to scan.
3. Complete the programming sequence by scanning the ENTER/EXIT Programming Mode bar code.

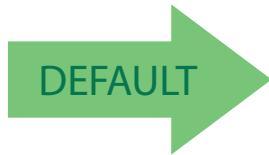

DataBar Expanded Minimum Read = 1



DataBar Expanded Minimum Read = 2



DataBar Expanded Minimum Read = 3



DataBar Expanded Minimum Read = 4

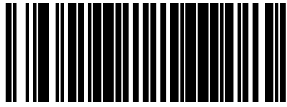

DataBar Expanded Length Control

This feature specifies either variable-length or fixed-length decoding for DataBar Expanded.

To set this feature:

1. Scan the ENTER/EXIT Programming Mode bar code.
2. Scan your selection from the barcodes below. You'll need to cover any unused barcodes on this and the facing page to ensure that the scanner reads only the barcode you intend to scan.
3. Complete the programming sequence by scanning the ENTER/EXIT Programming Mode bar code.

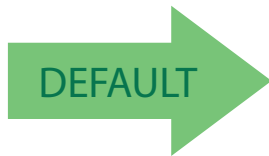

DataBar Expanded Length Control = Variable Length



DataBar Expanded Length Control = Fixed Length



DataBar Expanded Length 1

Length 1 is the minimum label length if in variable length mode, or the first fixed length if in fixed length mode. Length includes the bar code's data characters only.

To set this feature:

1. Scan the ENTER/EXIT Programming Mode bar code.
2. Scan the barcode, [Set DataBar Expanded Length 1](#) below. You'll need to cover any unused barcodes on this and the facing page to ensure that the scanner reads only the barcode you intend to scan.
3. Scan the appropriate digits from the [Keypad](#) in [Appendix C](#) that represent the desired label length. The selectable range for this option is 00 to 74. Pad all single digit numbers with a leading zero to yield a two-digit entry (00-74).
4. Complete the programming sequence by scanning the ENTER/EXIT Programming Mode bar code.



Set DataBar Expanded Length 1

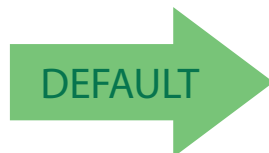

Default setting for this feature = 01

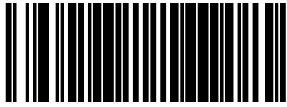

DataBar Expanded Length 2

Length 2 is the maximum label length if in variable length mode, or the second fixed length if in fixed length mode. Length includes the barcode's data characters only.



When in Fixed Length mode, if Length 2 is set to the value of 00 (zero), then only Length 1 will apply.

NOTE

To set this feature:

1. Scan the ENTER/EXIT Programming Mode bar code.
2. Scan the barcode, [Set DataBar Expanded Length 2](#) below. You'll need to cover any unused barcodes on this and the facing page to ensure that the scanner reads only the barcode you intend to scan.
3. Scan the appropriate digits from the [Keypad](#) in [Appendix C](#) that represent the desired label length. The selectable range for this option is 00 to 74. Pad all single digit numbers with a leading zero to yield a two-digit entry (00-74).
4. Complete the programming sequence by scanning the ENTER/EXIT Programming Mode bar code.



Set DataBar Expanded Length 2

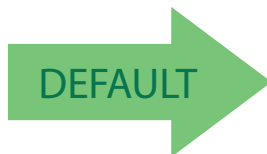

Default setting for this feature = 74



Code 39 Enable

Enables/disables the ability of the scanner to decode Code 39 labels.

To set this feature:

1. Scan the ENTER/EXIT Programming Mode bar code.
2. Scan either the enable or disable barcode below. You'll need to cover any unused barcodes on this and the facing page to ensure that the scanner reads only the barcode you intend to scan.
3. Complete the programming sequence by scanning the ENTER/EXIT Programming Mode bar code.



Code 39 = Disable



Code 39 = Enable



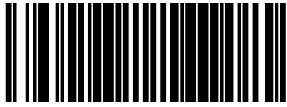

Code 39 Start Stop Character Transmission

Enables/disables transmission of Code 39 start and stop characters.



This item is ignored when the advanced feature, Full Label Edit, is enabled

NOTE

To set this feature:

1. Scan the ENTER/EXIT Programming Mode bar code.
2. Scan either the enable or disable barcode below. You'll need to cover any unused barcodes on this and the facing page to ensure that the scanner reads only the barcode you intend to scan.
3. Complete the programming sequence by scanning the ENTER/EXIT Programming Mode bar code.

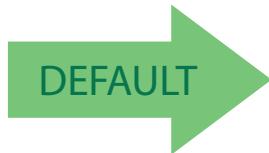

Code 39 Start Stop Character Transmission = Disable



Code 39 Start Stop Character Transmission = Enable



Code 39 Check Character Calculation

Enables/disables calculation and verification of an optional Code 39 check character. When disabled, any check character in label is treated as a data character.



If check calculation is disabled, the risk is increased that a misread can occur.

NOTE

To set this feature:

1. Scan the ENTER/EXIT Programming Mode bar code.
2. Scan either the enable or disable barcode below. You'll need to cover any unused barcodes on this and the facing page to ensure that the scanner reads only the barcode you intend to scan.
3. Complete the programming sequence by scanning the ENTER/EXIT Programming Mode bar code.

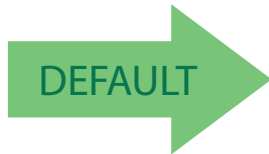

Code 39 Check Character Calculation = Disable



Code 39 Check Character Calculation = Enable



Code 39 Check Character Transmission

Enables/disables transmission of optional Code 39 check character.



This item is ignored when the advanced feature, Full Label Edit, is enabled.

NOTE

To set this feature:

1. Scan the ENTER/EXIT Programming Mode bar code.
2. Scan either the enable or disable barcode below. You'll need to cover any unused barcodes on this and the facing page to ensure that the scanner reads only the barcode you intend to scan.
3. Complete the programming sequence by scanning the ENTER/EXIT Programming Mode bar code.



Code 39 Check Character Transmission = Disable



Code 39 Check Character Transmission = Enable





Code 39 Full ASCII

Enables/disables the ability of the scanner to translate to Code 39 full ASCII labels.

To set this feature:

1. Scan the ENTER/EXIT Programming Mode bar code.
2. Scan either the enable or disable barcode below. You'll need to cover any unused barcodes on this and the facing page to ensure that the scanner reads only the barcode you intend to scan.
3. Complete the programming sequence by scanning the ENTER/EXIT Programming Mode bar code.

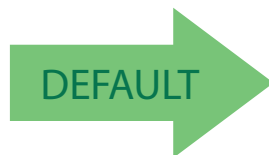

Code 39 Full ASCII = Disable



Code 39 Full ASCII = Enable

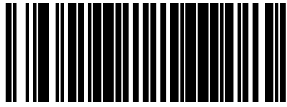

Code 39 Minimum Read

This feature specifies the minimum number of consecutive Code 39 decodes before is accepted as good read.

To set this feature:

1. Scan the ENTER/EXIT Programming Mode bar code.
2. Scan your selection from the bar codes below. You'll need to cover any unused bar codes on this and the facing page to ensure that the scanner reads only the bar code you intend to scan.
3. Complete the programming sequence by scanning the ENTER/EXIT Programming Mode bar code.

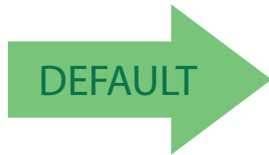

Code 39 Minimum Read = 1



Code 39 Minimum Read = 2



Code 39 Minimum Read = 3



Code 39 Minimum Read = 4



Code 39 Correlation

Enables/disables character correlation for Code 39.

To set this feature:

1. Scan the ENTER/EXIT Programming Mode bar code.
2. Scan either the enable or disable barcode below. You'll need to cover any unused barcodes on this and the facing page to ensure that the scanner reads only the barcode you intend to scan.
3. Complete the programming sequence by scanning the ENTER/EXIT Programming Mode bar code.

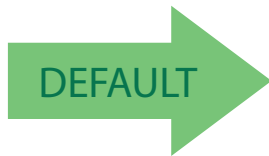

Code 39 Correlation = Disable



Code 39 Correlation = Enable

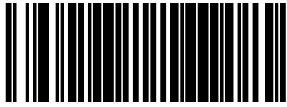

Code 39 Length Control

This feature specifies whether variable-length or fixed-length decoding will be set for Code 39.

To set this feature:

1. Scan the ENTER/EXIT Programming Mode bar code.
2. Scan your selection from the barcodes below. You'll need to cover any unused barcodes on this and the facing page to ensure that the scanner reads only the barcode you intend to scan.
3. Complete the programming sequence by scanning the ENTER/EXIT Programming Mode bar code.

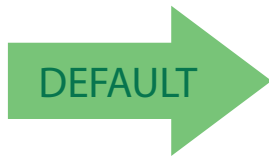

Code 39 Length Control = Variable Length



Code 39 Length Control = Fixed Length



Code 39 Length 1

If Code 39 Length Control is set to Fixed-Length decoding, this feature specifies Code 39 first fixed length. If Code 39 Length Control is set to Variable-Length decoding, this feature specifies the minimum label length.

To set this feature:

1. Scan the ENTER/EXIT Programming Mode bar code.
2. Scan the barcode, [Set Code 39 Length 1](#) below. You'll need to cover any unused barcodes on this and the facing page to ensure that the scanner reads only the barcode you intend to scan.
3. Scan the appropriate digits from the [Keypad](#) in [Appendix C](#) that represent the desired label length. The selectable range for this option is 00 to 50. Pad all single digit numbers with a leading zero to yield a two-digit entry (00-50).
4. Complete the programming sequence by scanning the ENTER/EXIT Programming Mode bar code.



Set Code 39 Length 1



Default setting for this feature = 02



Code 39 Length 2

If Code 39 Length Control is set to Fixed-Length decoding, this feature specifies Code 39 second fixed length. If Code 39 Length Control is set to Variable-Length decoding, this feature specifies the maximum label length.



When in Fixed Length mode, if Length 2 is set to the value of 00, then only Length 1 will apply

NOTE

To set this feature:

1. Scan the ENTER/EXIT Programming Mode bar code.
2. Scan the barcode, [Set Code 39 Length 2](#) below. You'll need to cover any unused barcodes on this and the facing page to ensure that the scanner reads only the barcode you intend to scan.
3. Scan the appropriate digits from the [Keypad](#) in [Appendix C](#) that represent the desired label length. The selectable range for this option is 00, no second fixed length, or 01 to 50. Pad all single digit numbers with a leading zero to yield a two-digit entry (00-50).
4. Complete the programming sequence by scanning the ENTER/EXIT Programming Mode bar code.



Set Code 39 Length 2

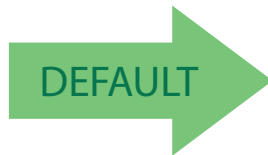

Default setting for this feature = 50



Code 39 Stitching

Enables/disables stitching for Code 39 labels. When parts of a Code 39 barcode are presented to the scanner with this feature enabled, the barcode parts will be assembled by the scanner's software, and the data will be decoded if all barcode proofing requirements are met.

To set this feature:

1. Scan the ENTER/EXIT Programming Mode bar code.
2. Scan your selection from the barcodes below. You'll need to cover any unused barcodes on this and the facing page to ensure that the scanner reads only the barcode you intend to scan.
3. Complete the programming sequence by scanning the ENTER/EXIT Programming Mode bar code.



Code 39 Stitching = Disable



Code 39 Stitching = Enable





Enter/Exit Programming Mode

Code 39 Require Margins

Enables/disables the requirement that quiet zones be present in a Code 39 bar code.

To set this feature:

1. Scan the ENTER/EXIT Programming Mode bar code.
2. Scan either the enable or disable bar code below. You'll need to cover any unused bar codes on this and the facing page to ensure that the scanner reads only the bar code you intend to scan.
3. Complete the programming sequence by scanning the ENTER/EXIT Programming Mode bar code.

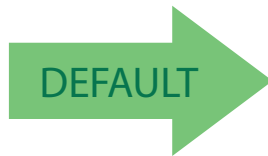

Code 39 Require Margins = Quiet Zones Not Required



Code 39 Require Margins = Quiet Zones Required



Code 32 Italian Pharmacode Enable

Enables/disables the ability of the scanner to decode Italian Pharmaceutical Code 39 labels.

To set this feature:

1. Scan the ENTER/EXIT Programming Mode bar code.
2. Scan either the enable or disable barcode below. You'll need to cover any unused barcodes on this and the facing page to ensure that the scanner reads only the barcode you intend to scan.
3. Complete the programming sequence by scanning the ENTER/EXIT Programming Mode bar code.

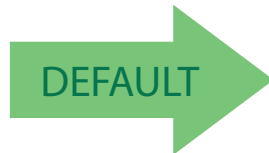

Code 32 Italian Pharmacode Enable = Disable



Code 32 Italian Pharmacode Enable = Enable



Code 32 Start Stop Character Transmission

Enables/ disables transmission of start and stop characters for Code 32.



This item is ignored when the advanced feature, Full Label Edit, is enabled.

NOTE

To set this feature:

1. Scan the ENTER/EXIT Programming Mode bar code.
2. Scan either the enable or disable barcode below. You'll need to cover any unused barcodes on this and the facing page to ensure that the scanner reads only the barcode you intend to scan.
3. Complete the programming sequence by scanning the ENTER/EXIT Programming Mode bar code.

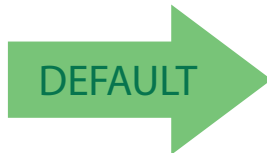

Code 32 Start Stop Character Transmission = Disable



Code 32 Start Stop Character Transmission = Enable



Code 32 Check Character Transmission

Enables/disables transmission of Code 32 check character.



This item is ignored when the advanced feature, Full Label Edit, is enabled.

NOTE

To set this feature:

1. Scan the ENTER/EXIT Programming Mode bar code.
2. Scan either the enable or disable barcode below. You'll need to cover any unused barcodes on this and the facing page to ensure that the scanner reads only the barcode you intend to scan.
3. Complete the programming sequence by scanning the ENTER/EXIT Programming Mode bar code.

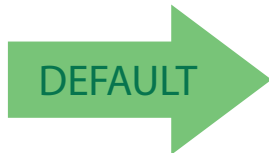

Code 32 Check Character Transmission = Disable



Code 32 Check Character Transmission = Enable

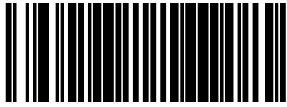

Code 128 Enable

Enables/disables the ability of the scanner to decode Code 128 labels.

To set this feature:

1. Scan the ENTER/EXIT Programming Mode bar code.
2. Scan either the enable or disable barcode below. You'll need to cover any unused barcodes on this and the facing page to ensure that the scanner reads only the barcode you intend to scan.
3. Complete the programming sequence by scanning the ENTER/EXIT Programming Mode bar code.



Code 128 = Disable



Code 128 = Enable





Code 128 Transmit Function Characters

Enables/disables transmission of Code 128 function characters 1, 2, 3, and 4.



Disabled is the recommended setting for all interfaces.

NOTE

To set this feature:

1. Scan the ENTER/EXIT Programming Mode bar code.
2. Scan either the enable or disable barcode below. You'll need to cover any unused barcodes on this and the facing page to ensure that the scanner reads only the barcode you intend to scan.
3. Complete the programming sequence by scanning the ENTER/EXIT Programming Mode bar code.

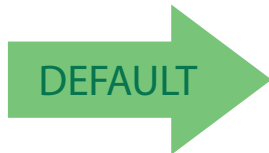

Code 128 Transmit Function Characters = Disable



Code 128 Transmit Function Characters = Enable

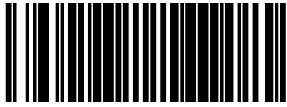

Enter/Exit Programming Mode

Expand Code128 to Code 39

Enables/disables expansion of Code 128 labels to Code 39.

To set this feature:

1. Scan the ENTER/EXIT Programming Mode bar code.
2. Scan either the enable or disable barcode below. You'll need to cover any unused barcodes on this and the facing page to ensure that the scanner reads only the barcode you intend to scan.
3. Complete the programming sequence by scanning the ENTER/EXIT Programming Mode bar code.



Expand Code128 to Code 39 = Disable



Expand Code128 to Code 39 = Enable



Code 128 Minimum Read

This feature specifies the minimum number of consecutive Code 128 decodes before is accepted as good read.

To set this feature:

1. Scan the ENTER/EXIT Programming Mode bar code.
2. Scan your selection from the bar codes below. You'll need to cover any unused bar codes on this and the facing page to ensure that the scanner reads only the bar code you intend to scan.
3. Complete the programming sequence by scanning the ENTER/EXIT Programming Mode bar code.

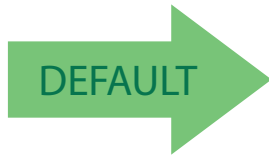

Code 128 Minimum Read = 1



Code 128 Minimum Read = 2



Code 128 Minimum Read = 3



Code 128 Minimum Read = 4



Enter/Exit Programming Mode

Code 128 Correlation

Enables/disables character correlation for Code 128.

To set this feature:

1. Scan the ENTER/EXIT Programming Mode bar code.
2. Scan either the enable or disable barcode below. You'll need to cover any unused barcodes on this and the facing page to ensure that the scanner reads only the barcode you intend to scan.
3. Complete the programming sequence by scanning the ENTER/EXIT Programming Mode bar code.

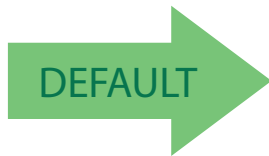

Code 128 Correlation = Disable



Code 128 Correlation = Enable



Code 128 Length Control

This feature specifies whether variable-length or fixed-length decoding will be set for Code 128.

To set this feature:

1. Scan the ENTER/EXIT Programming Mode bar code.
2. Scan your selection from the barcodes below. You'll need to cover any unused barcodes on this and the facing page to ensure that the scanner reads only the barcode you intend to scan.
3. Complete the programming sequence by scanning the ENTER/EXIT Programming Mode bar code.

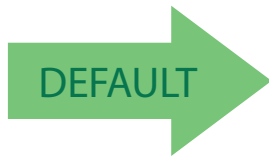

Code 128 Length Control = Variable Length



Code 128 Length Control = Fixed Length



Code 128 Length 1

If Code 128 Length Control is set to Fixed-Length decoding, this feature specifies Code 128 first fixed length. If Code 128 Length Control is set to Variable-Length decoding, this feature specifies the minimum label length.

To set this feature:

1. Scan the ENTER/EXIT Programming Mode bar code.
2. Scan the barcode, [Set Code 128 Length 1](#) below. You'll need to cover any unused barcodes on this and the facing page to ensure that the scanner reads only the barcode you intend to scan.
3. Scan the appropriate digits from the [Keypad](#) in [Appendix C](#) that represent the desired label length. The selectable range for this option is 01 to 80. Pad all single digit numbers with a leading zero to yield a two-digit entry (01-80).
4. Complete the programming sequence by scanning the ENTER/EXIT Programming Mode bar code.



Set Code 128 Length 1



Default setting for this feature = 01



Code 128 Length 2

If Code 128 Length Control is set to Fixed-Length decoding, this feature specifies Code 128 second fixed length. If Code 128 Length Control is set to Variable-Length decoding, this feature specifies the maximum label length.



When in Fixed Length mode, if Length 2 is set to the value of 00 (zero), then only Length 1 will apply.

NOTE

To set this feature:

1. Scan the ENTER/EXIT Programming Mode bar code.
2. Scan the barcode, [Set Code 128 Length 2](#) below. You'll need to cover any unused barcodes on this and the facing page to ensure that the scanner reads only the barcode you intend to scan.
3. Scan the appropriate digits from the [Keypad](#) in [Appendix C](#) that represent the desired label length. The selectable range for this option is 01 to 80. Pad all single digit numbers with a leading zero to yield a two-digit entry (01-80).
4. Complete the programming sequence by scanning the ENTER/EXIT Programming Mode bar code.



Set Code 128 Length 2

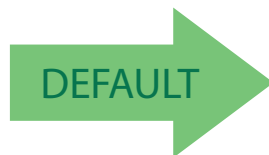

Default setting for this feature = 80

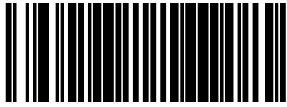

Code 128 Stitching

Enables/disables stitching for Code 128 labels. When parts of a Code 128 barcode are presented to the scanner with this feature enabled, the barcode parts will be assembled by the scanner's software, and the data will be decoded if all barcode proofing requirements are met.

To set this feature:

1. Scan the ENTER/EXIT Programming Mode bar code.
2. Scan your selection from the barcodes below. You'll need to cover any unused barcodes on this and the facing page to ensure that the scanner reads only the barcode you intend to scan.
3. Complete the programming sequence by scanning the ENTER/EXIT Programming Mode bar code.



Code 128 Stitching = Disable



Code 128 Stitching = Enable





EAN-128 Enable

Enables/disables the ability of the scanner to translate EAN128 labels to the EAN128 data format.

To set this feature:

1. Scan the ENTER/EXIT Programming Mode bar code.
2. Scan either the enable or disable barcode below. You'll need to cover any unused barcodes on this and the facing page to ensure that the scanner reads only the barcode you intend to scan.
3. Complete the programming sequence by scanning the ENTER/EXIT Programming Mode bar code.

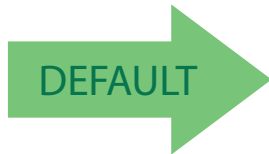

EAN-128 = Transmit EAN128 labels in Code128 data format



EAN-128 = Transmit EAN128 labels in EAN128 data format

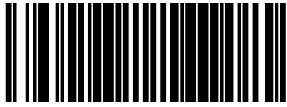

Interleaved 2 of 5 (I 2 OF 5) Enable

Enables/disables the ability of the scanner to decode Interleaved 2 of 5 labels.

To set this feature:

1. Scan the ENTER/EXIT Programming Mode bar code.
2. Scan either the enable or disable barcode below. You'll need to cover any unused barcodes on this and the facing page to ensure that the scanner reads only the barcode you intend to scan.
3. Complete the programming sequence by scanning the ENTER/EXIT Programming Mode bar code.

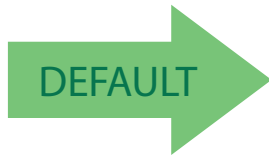

I 2 of 5 = Disable



I 2 of 5 = Enable



I 2 of 5 Check Character Calculation

Enables/disables calculation and verification of an optional Interleaved 2 of 5 check character.



If check character calculation is disabled, the risk is increased that a misread can occur. When disabled, any check characters in a barcode are treated as data characters.

NOTE

1. To set this feature:
2. Scan the ENTER/EXIT Programming Mode bar code.
3. Scan either the enable or disable barcode below. You'll need to cover any unused barcodes on this and the facing page to ensure that the scanner reads only the barcode you intend to scan.
4. Complete the programming sequence by scanning the ENTER/EXIT Programming Mode bar code.

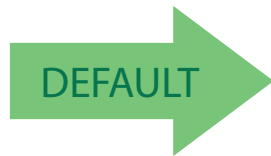

I 2 of 5 Check Character Calculation = Disable



I 2 of 5 Check Character Calculation = Enable



I 2 of 5 Check Character Transmission

Enables/disables transmission of an optional Interleaved 2 of 5 check character.



This feature applies only when I 2 of 5 Check Character Calculation is enabled. This item is ignored when the advanced feature, Full Label Edit, is enabled.

NOTE

To set this feature:

1. Scan the ENTER/EXIT Programming Mode bar code.
2. Scan either the enable or disable barcode below. You'll need to cover any unused barcodes on this and the facing page to ensure that the scanner reads only the barcode you intend to scan.
3. Complete the programming sequence by scanning the ENTER/EXIT Programming Mode bar code.



I 2 of 5 Check Character Transmission = Disable



I 2 of 5 Check Character Transmission = Enable





I 2 of 5 Minimum Read

This feature specifies the minimum number of consecutive I 2 of 5 decodes before is accepted as good read.

To set this feature:

1. Scan the ENTER/EXIT Programming Mode bar code.
2. Scan your selection from the bar codes below. You'll need to cover any unused bar codes on this and the facing page to ensure that the scanner reads only the bar code you intend to scan.
3. Complete the programming sequence by scanning the ENTER/EXIT Programming Mode bar code.

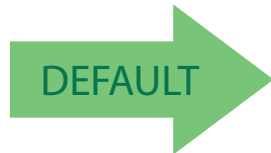

I 2 of 5 Minimum Read = 1



I 2 of 5 Minimum Read = 2



I 2 of 5 Minimum Read = 3



I 2 of 5 Minimum Read = 4

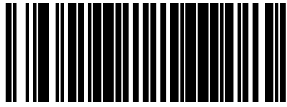

Enter/Exit Programming Mode

I 2 of 5 Correlation

Enables/disables character correlation for I 2 of 5.

To set this feature:

1. Scan the ENTER/EXIT Programming Mode bar code.
2. Scan either the enable or disable barcode below. You'll need to cover any unused barcodes on this and the facing page to ensure that the scanner reads only the barcode you intend to scan.
3. Complete the programming sequence by scanning the ENTER/EXIT Programming Mode bar code.

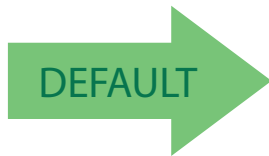

I 2 of 5 Correlation = Disable

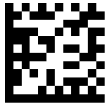

I 2 of 5 Correlation = Enable



I 2 of 5 Length Control

This feature specifies whether variable-length or fixed-length decoding will be set for I 2 of 5.

To set this feature:

1. Scan the ENTER/EXIT Programming Mode bar code.
2. Scan your selection from the barcodes below. You'll need to cover any unused barcodes on this and the facing page to ensure that the scanner reads only the barcode you intend to scan.
3. Complete the programming sequence by scanning the ENTER/EXIT Programming Mode bar code.

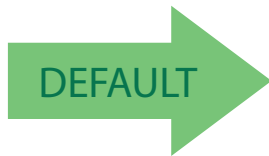

I 2 of 5 Length Control = Variable Length



I 2 of 5 Length Control = Fixed Length

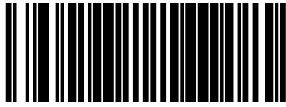

I 2 of 5 Length 1

If I 2 of 5 Length Control is set to Fixed-Length decoding, this feature specifies I 2 of 5 first fixed length. If I 2 of 5 Length Control is set to Variable-Length decoding, this feature specifies the minimum label length.

To set this feature:

1. Scan the ENTER/EXIT Programming Mode bar code.
2. Scan the barcode, [Set I 2 of 5 Length 1](#) below. You'll need to cover any unused barcodes on this and the facing page to ensure that the scanner reads only the barcode you intend to scan.
3. Scan the appropriate digits from the [Keypad](#) in [Appendix C](#) that represent the desired label length. The selectable range for this option is 02 to 50, even numbers only. Pad all single digit numbers with a leading zero to yield a two-digit entry (02-50).
4. Complete the programming sequence by scanning the ENTER/EXIT Programming Mode bar code.



Set I 2 of 5 Length 1

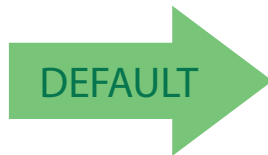

Default setting for this feature = 06



I 2 of 5 Length 2

If I 2 of 5 Length Control is set to Fixed-Length decoding, this feature specifies I 2 of 5 second fixed length. If I 2 of 5 Length Control is set to Variable-Length decoding, this feature specifies the maximum label length.



When in Fixed Length mode, if Length 2 is set to the value of 00 (zero), then only Length 1 will apply.

NOTE

To set this feature:

1. Scan the ENTER/EXIT Programming Mode bar code.
2. Scan the barcode, [Set I 2 of 5 Length 2](#) below. You'll need to cover any unused barcodes on this and the facing page to ensure that the scanner reads only the barcode you intend to scan.
3. Scan the appropriate digits from the [Keypad](#) in [Appendix C](#) that represent the desired label length. The selectable range for this option is 00, or 02 to 50; even numbers only. Pad all single digit numbers with a leading zero to yield a two-digit entry (02-50).
4. Complete the programming sequence by scanning the ENTER/EXIT Programming Mode bar code.



Set I 2 of 5 Length 2

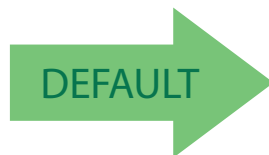

Default setting for this feature = 50

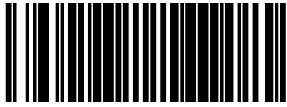

I 2 of 5 Stitching

Enables/disables stitching for I 2 of 5 labels. When parts of an I 2 of 5 barcode are presented to the scanner with this feature enabled, the barcode parts will be assembled by the scanner's software, and the data will be decoded if all barcode proofing requirements are met.

To set this feature:

1. Scan the ENTER/EXIT Programming Mode bar code.
2. Scan your selection from the barcodes below. You'll need to cover any unused barcodes on this and the facing page to ensure that the scanner reads only the barcode you intend to scan.
3. Complete the programming sequence by scanning the ENTER/EXIT Programming Mode bar code.

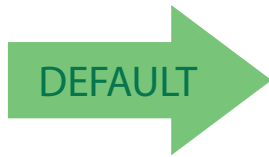

I 2 of 5 Stitching = Disable



I 2 of 5 Stitching = Enable



Codabar Enable

Enables/disables the ability of the scanner to decode Codabar labels.

To set this feature:

1. Scan the ENTER/EXIT Programming Mode bar code.
2. Scan either the enable or disable barcode below. You'll need to cover any unused barcodes on this and the facing page to ensure that the scanner reads only the barcode you intend to scan.
3. Complete the programming sequence by scanning the ENTER/EXIT Programming Mode bar code.

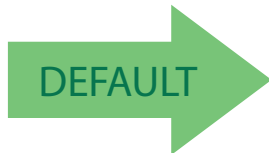

Codabar = Disable



Codabar = Enable



Codabar Start Stop Character Transmission

Enables/disables transmission of Codabar start and stop characters.



This item is ignored when the advanced feature, Full Label Edit, is enabled.

NOTE

To set this feature:

1. Scan the ENTER/EXIT Programming Mode bar code.
2. Scan either the enable or disable barcode below. You'll need to cover any unused barcodes on this and the facing page to ensure that the scanner reads only the barcode you intend to scan.
3. Complete the programming sequence by scanning the ENTER/EXIT Programming Mode bar code.



Codabar Start Stop Character Transmission = Disable



Codabar Start Stop Character Transmission = Enable





Codabar Start Stop Character Set

This feature specifies the format of transmitted Codabar start/stop characters.

Options are:

- ABCD/TN* E
- ABCD/ABCD
- abcd/tn* e
- abcd/abcd

To set this feature:

1. Scan the ENTER/EXIT Programming Mode bar code.
2. Scan the barcode below or from the following page representing the desired option. You'll need to cover any unused barcodes and facing pages to ensure that the scanner reads only the barcode you intend to scan.
3. Complete the programming sequence by scanning the ENTER/EXIT Programming Mode bar code.



Codabar Start Stop Character Set = ABCD/TN* E



Codabar Start Stop Character Set = ABCD/ABCD



Codabar Start Stop Character Set = abcd/tn* e



Codabar Start Stop Character Set = abcd/abcd



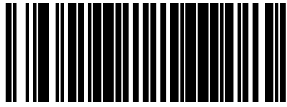

Codabar Start Stop Character Match

Enables/disables the requirement that start and stop characters match.

To set this feature:

1. Scan the ENTER/EXIT Programming Mode bar code.
2. Scan either the enable or disable barcode below. You'll need to cover any unused barcodes on this and the facing page to ensure that the scanner reads only the barcode you intend to scan.
3. Complete the programming sequence by scanning the ENTER/EXIT Programming Mode bar code.

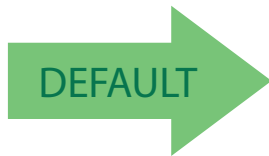

Codabar Start Stop Character Match = Disable



Codabar Start Stop Character Match = Enable



Codabar Check Character Calculation

Enables/disables calculation and verification of an optional Codabar check character.



If check character calculation is disabled, the risk is increased that a misread can occur. When disabled, any check characters in a barcode are treated as data characters.

NOTE

To set this feature:

1. Scan the ENTER/EXIT Programming Mode bar code.
2. Scan either the enable or disable barcode below. You'll need to cover any unused barcodes on this and the facing page to ensure that the scanner reads only the barcode you intend to scan.
3. Complete the programming sequence by scanning the ENTER/EXIT Programming Mode bar code.

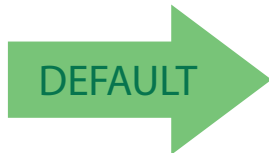

Codabar Check Character Calculation = Disable



Codabar Check Character Calculation = Enable

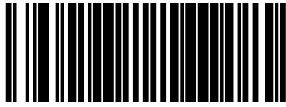

Codabar Check Character Transmission

Enables/disables transmission of an optional Codabar check character.



Applies only when Codabar Check Character Calculation is enabled. This item is ignored when the advanced feature, Full Label Edit, is enabled.

NOTE

To set this feature:

1. Scan the ENTER/EXIT Programming Mode bar code.
2. Scan either the enable or disable barcode below. You'll need to cover any unused barcodes on this and the facing page to ensure that the scanner reads only the barcode you intend to scan.
3. Complete the programming sequence by scanning the ENTER/EXIT Programming Mode bar code.



Codabar Check Character Transmission = Disable



Codabar Check Character Transmission = Enable





Codabar Minimum Read

This feature specifies the minimum number of consecutive Codabar decodes before is accepted as good read.

To set this feature:

1. Scan the ENTER/EXIT Programming Mode bar code.
2. Scan your selection from the bar codes below. You'll need to cover any unused bar codes on this and the facing page to ensure that the scanner reads only the bar code you intend to scan.
3. Complete the programming sequence by scanning the ENTER/EXIT Programming Mode bar code.

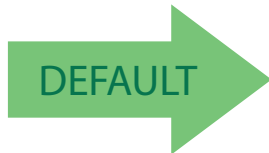

Codabar Minimum Read = 1



Codabar Minimum Read = 2



Codabar Minimum Read = 3



Codabar Minimum Read = 4

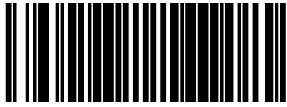

Codabar Correlation

Enables/disables character correlation for Codabar.

To set this feature:

1. Scan the ENTER/EXIT Programming Mode bar code.
2. Scan either the enable or disable barcode below. You'll need to cover any unused barcodes on this and the facing page to ensure that the scanner reads only the barcode you intend to scan.
3. Complete the programming sequence by scanning the ENTER/EXIT Programming Mode bar code.

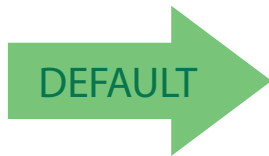

Codabar Correlation = Disable



Codabar Correlation = Enable



Codabar Length Control

This feature specifies whether variable-length or fixed-length decoding will be set for Codabar.

To set this feature:

1. Scan the ENTER/EXIT Programming Mode bar code.
2. Scan your selection from the barcodes below. You'll need to cover any unused barcodes on this and the facing page to ensure that the scanner reads only the barcode you intend to scan.
3. Complete the programming sequence by scanning the ENTER/EXIT Programming Mode bar code.

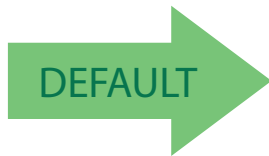

Codabar Length Control = Variable Length



Codabar Length Control = Fixed Length

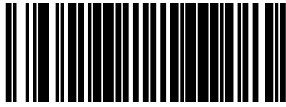

Codabar Length 1

If Codabar Length Control is set to Fixed-Length decoding, this feature specifies Codabar first fixed length. If Codabar Length Control is set to Variable-Length decoding, this feature specifies the minimum label length.

To set this feature:

1. Scan the ENTER/EXIT Programming Mode bar code.
2. Scan the barcode, [Set Codabar Length 1](#) below. You'll need to cover any unused barcodes on this and the facing page to ensure that the scanner reads only the barcode you intend to scan.
3. Scan the appropriate digits from the [Keypad](#) in [Appendix C](#) that represent the desired label length. The selectable range for this option is 03 to 50. Pad all single digit numbers with a leading zero to yield a two-digit entry (03-50).
4. Complete the programming sequence by scanning the ENTER/EXIT Programming Mode bar code.



Set Codabar Length 1

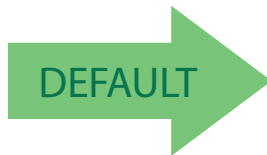

Default setting for this feature = 03



Codabar Length 2

If Codabar Length Control is set to Fixed-Length decoding, this feature specifies Codabar second fixed length. If Codabar Length Control is set to Variable-Length decoding, this feature specifies the maximum label length.



When in Fixed Length mode, if Length 2 is set to the value of 00 (zero), then only Length 1 will apply.

NOTE

To set this feature:

1. Scan the ENTER/EXIT Programming Mode bar code.
2. Scan the barcode, [Set Codabar Length 2](#) below. You'll need to cover any unused barcodes on this and the facing page to ensure that the scanner reads only the barcode you intend to scan.
3. Scan the appropriate digits from the [Keypad](#) in [Appendix C](#) that represent the desired label length. The selectable range for this option is 00 (meaning ignore this length), or 03 to 50. Pad all single digit numbers with a leading zero to yield a two-digit entry (03-50).
4. Complete the programming sequence by scanning the ENTER/EXIT Programming Mode bar code.



Set Codabar Length 2

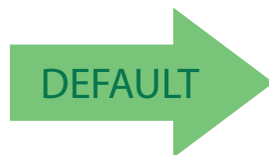

Default setting for this feature = 50

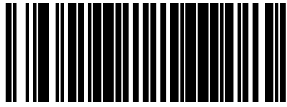

Codabar Stitching

Enables/disables stitching for Codabar labels. When parts of a Codabar barcode are presented to the scanner with this feature enabled, the barcode parts will be assembled by the scanner's software, and the data will be decoded if all barcode proofing requirements are met.

To set this feature:

1. Scan the ENTER/EXIT Programming Mode bar code.
2. Scan your selection from the barcodes below. You'll need to cover any unused barcodes on this and the facing page to ensure that the scanner reads only the barcode you intend to scan.
3. Complete the programming sequence by scanning the ENTER/EXIT Programming Mode bar code.

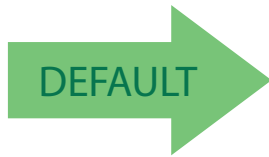

Codabar Stitching = Disable



Codabar Stitching = Enable



Codabar Require Margins

Enables/disables the requirement that quiet zones be present in a Codabar bar code.

To set this feature:

1. Scan the ENTER/EXIT Programming Mode bar code.
2. Scan either the enable or disable bar code below. You'll need to cover any unused bar codes on this and the facing page to ensure that the scanner reads only the bar code you intend to scan.
3. Complete the programming sequence by scanning the ENTER/EXIT Programming Mode bar code.



Codabar Require Margins = Quiet Zones Not Required



Codabar Require Margins = Quiet Zones Required

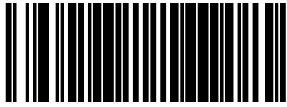

Code 93 Enable

Enables/disables the ability of the scanner to decode Code 93 labels.

To set this feature:

1. Scan the ENTER/EXIT Programming Mode bar code.
2. Scan either the enable or disable barcode below. You'll need to cover any unused barcodes on this and the facing page to ensure that the scanner reads only the barcode you intend to scan.
3. Complete the programming sequence by scanning the ENTER/EXIT Programming Mode bar code.

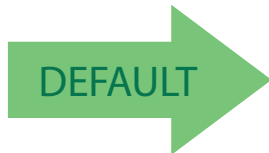

Code 93 = Disable



Code 93 = Enable



Code 93 Minimum Read

This feature specifies the minimum number of consecutive Code 93 decodes before is accepted as good read.

To set this feature:

1. Scan the ENTER/EXIT Programming Mode bar code.
2. Scan your selection from the bar codes below. You'll need to cover any unused bar codes on this and the facing page to ensure that the scanner reads only the bar code you intend to scan.
3. Complete the programming sequence by scanning the ENTER/EXIT Programming Mode bar code.

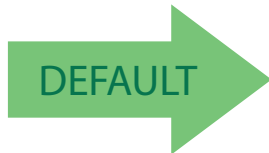

Code 93 Minimum Read = 1



Code 93 Minimum Read = 2



Code 93 Minimum Read = 3



Code 93 Minimum Read = 4

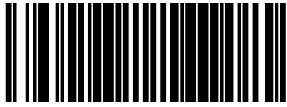

Enter/Exit Programming Mode

Code 93 Correlation

Enables/disables character correlation for Code 93.

To set this feature:

1. Scan the ENTER/EXIT Programming Mode bar code.
2. Scan either the enable or disable barcode below. You'll need to cover any unused barcodes on this and the facing page to ensure that the scanner reads only the barcode you intend to scan.
3. Complete the programming sequence by scanning the ENTER/EXIT Programming Mode bar code.

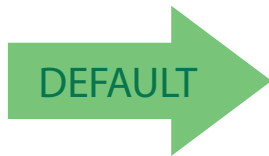

Code 93 Correlation = Disable



Code 93 Correlation = Enable



Code 93 Length Control

This feature specifies whether variable-length or fixed-length decoding will be set for Code 93.

To set this feature:

1. Scan the ENTER/EXIT Programming Mode bar code.
2. Scan your selection from the barcodes below. You'll need to cover any unused barcodes on this and the facing page to ensure that the scanner reads only the barcode you intend to scan.
3. Complete the programming sequence by scanning the ENTER/EXIT Programming Mode bar code.

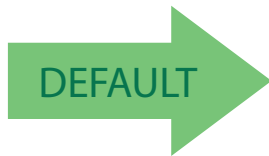

Codabar Length Control = Variable Length

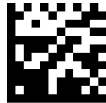

Codabar Length Control = Fixed Length

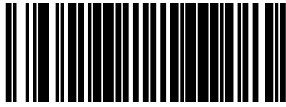

Code 93 Length 1

If Code 93 Length Control is set to Fixed-Length decoding, this feature specifies Code 93 first fixed length. If Code 93 Length Control is set to Variable-Length decoding, this feature specifies the minimum label length.

To set this feature:

1. Scan the ENTER/EXIT Programming Mode bar code.
2. Scan the barcode, [Set Code 93 Length 1](#) below. You'll need to cover any unused barcodes on this and the facing page to ensure that the scanner reads only the barcode you intend to scan.
3. Scan the appropriate digits from the [Keypad](#) in [Appendix C](#) that represent the desired label length. The selectable range for this option is 01 to 50. Pad all single digit numbers with a leading zero to yield a two-digit entry (01-50).
4. Complete the programming sequence by scanning the ENTER/EXIT Programming Mode bar code.



Set Code 93 Length 1



Default setting for this feature = 01



Code 93 Length 2

If Code 93 Length Control is set to Fixed-Length decoding, this feature specifies Code 93 second fixed length. If Code 93 Length Control is set to Variable-Length decoding, this feature specifies the maximum label length.



When in Fixed Length mode, if Fixed Length 2 is set to the value of 00 (zero), then only Length 1 will apply.

NOTE

To set this feature:

1. Scan the ENTER/EXIT Programming Mode bar code.
2. Scan the barcode, [Set Code 93 Length 2](#) below. You'll need to cover any unused barcodes on this and the facing page to ensure that the scanner reads only the barcode you intend to scan.
3. Scan the appropriate digits from the [Keypad](#) in [Appendix C](#) that represent the desired label length. The selectable range for this option is 00 (meaning ignore this length), or 01 to 50. Pad all single digit numbers with a leading zero to yield a two-digit entry (01-50).
4. Complete the programming sequence by scanning the ENTER/EXIT Programming Mode bar code.



Set Code 93 Length 2

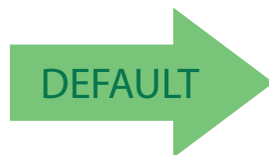

Default setting for this feature = 50

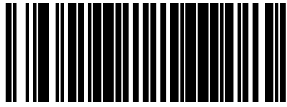

Enter/Exit Programming Mode

Code 93 Stitching

Enables/disables stitching for Code 93 labels. When parts of a Code 93 barcode are presented to the scanner with this feature enabled, the barcode parts will be assembled by the scanner's software, and the data will be decoded if all barcode proofing requirements are met.

To set this feature:

1. Scan the ENTER/EXIT Programming Mode bar code.
2. Scan your selection from the barcodes below. You'll need to cover any unused barcodes on this and the facing page to ensure that the scanner reads only the barcode you intend to scan.
3. Complete the programming sequence by scanning the ENTER/EXIT Programming Mode bar code.



Code 93 Stitching = Disable



Code 93 Stitching = Enable





MSI Enable

Enables/disables the ability of the scanner to decode MSI labels.

To set this feature:

1. Scan the ENTER/EXIT Programming Mode bar code.
2. Scan either the enable or disable barcode below. You'll need to cover any unused barcodes on this and the facing page to ensure that the scanner reads only the barcode you intend to scan.
3. Complete the programming sequence by scanning the ENTER/EXIT Programming Mode bar code.

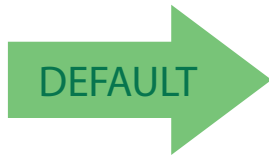

MSI = Disable



MSI = Enable

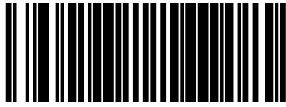

MSI Check Character Calculation

Enables/disables calculation and verification of optional MSI check characters.



If check character calculation is disabled, the risk is increased that a misread can occur. When disabled, any check characters in a barcode are treated as data characters.

NOTE

To set this feature:

1. Scan the ENTER/EXIT Programming Mode bar code.
2. Scan either the enable or disable barcode below. You'll need to cover any unused barcodes on this and the facing page to ensure that the scanner reads only the barcode you intend to scan.
3. Complete the programming sequence by scanning the ENTER/EXIT Programming Mode bar code.



MSI Check Character Calculation = Disable



MSI Check Character Calculation = Enable





MSI Number of Check Characters

Specifies number of MSI check characters to be calculated and verified.



Check characters are always modulus 10.

NOTE

To set this feature:

1. Scan the ENTER/EXIT Programming Mode bar code.
2. Scan the barcode below representing the desired number of MSI check characters to be calculated and verified. You'll need to cover any unused barcodes on this and the facing page to ensure that the scanner reads only the barcode you intend to scan.
3. Complete the programming sequence by scanning the ENTER/EXIT Programming Mode bar code.

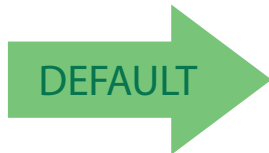

MSI Number of Check Characters = 1



MSI Number of Check Characters = 2



MSI Check Character Transmission

Enables/disables transmission of optional MSI check characters.



This feature applies only when MSI Check Character Calculation is enabled. This item is ignored when the advanced feature, Full Label Edit, is enabled.

NOTE

To set this feature:

1. Scan the ENTER/EXIT Programming Mode bar code.
2. Scan either the enable or disable barcode below. You'll need to cover any unused barcodes on this and the facing page to ensure that the scanner reads only the barcode you intend to scan.
3. Complete the programming sequence by scanning the ENTER/EXIT Programming Mode bar code.



MSI Check Character Transmission = Disable



MSI Check Character Transmission = Enable





MSI Minimum Read

This feature specifies the minimum number of consecutive MSI decodes before is accepted as good read.

To set this feature:

1. Scan the ENTER/EXIT Programming Mode bar code.
2. Scan your selection from the bar codes below. You'll need to cover any unused bar codes on this and the facing page to ensure that the scanner reads only the bar code you intend to scan.
3. Complete the programming sequence by scanning the ENTER/EXIT Programming Mode bar code.

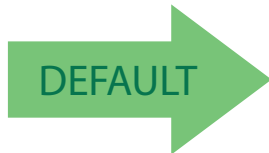

MSI Minimum Read = 1



MSI Minimum Read = 2



MSI Minimum Read = 3



MSI Minimum Read = 4



MSI Correlation

Enables/disables character correlation for MSI.

To set this feature:

1. Scan the ENTER/EXIT Programming Mode bar code.
2. Scan either the enable or disable barcode below. You'll need to cover any unused barcodes on this and the facing page to ensure that the scanner reads only the barcode you intend to scan.
3. Complete the programming sequence by scanning the ENTER/EXIT Programming Mode bar code.

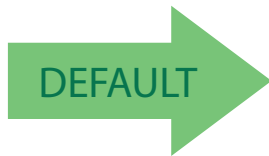

MSI Correlation = Disable



MSI Correlation = Enable



MSI Length Control

This feature specifies whether variable-length or fixed-length decoding will be set for MSI.

To set this feature:

1. Scan the ENTER/EXIT Programming Mode bar code.
2. Scan your selection from the barcodes below. You'll need to cover any unused barcodes on this and the facing page to ensure that the scanner reads only the barcode you intend to scan.
3. Complete the programming sequence by scanning the ENTER/EXIT Programming Mode bar code.

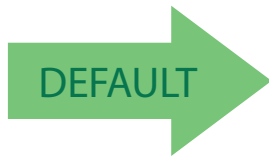

MSI Length Control = Variable Length



MSI Length Control = Fixed Length



MSI Length 1

If MSI Length Control is set to Fixed-Length decoding, this feature specifies MSI first fixed length. If MSI Length Control is set to Variable-Length decoding, this feature specifies the minimum label length.

To set this feature:

1. Scan the ENTER/EXIT Programming Mode bar code.
2. Scan the barcode, [Set MSI Length 1](#) below. You'll need to cover any unused barcodes on this and the facing page to ensure that the scanner reads only the barcode you intend to scan.
3. Scan the appropriate digits from the [Keypad](#) in [Appendix C](#) that represent the desired label length. The selectable range for this option is 4 to 16. Pad all single digit numbers with a leading zero to yield a two-digit entry (04-16).
4. Complete the programming sequence by scanning the ENTER/EXIT Programming Mode bar code.



Set MSI Length 1



Default setting for this feature = 04



MSI Length 2

If MSI Length Control is set to Fixed-Length decoding, this feature specifies MSI second fixed length. If MSI Length Control is set to Variable-Length decoding, this feature specifies the maximum label length.



When in Fixed Length mode, if Length 2 is set to the value 00 (zero), then only Length 1 will apply.

NOTE

To set this feature:

1. Scan the ENTER/EXIT Programming Mode bar code.
2. Scan the barcode, [Set MSI Length 2](#) below. You'll need to cover any unused barcodes on this and the facing page to ensure that the scanner reads only the barcode you intend to scan.
3. Scan the appropriate digits from the [Keypad](#) in [Appendix C](#) that represent the desired label length. The selectable range for this option is 00 (meaning ignore this length), or 04 to 16. Pad all single digit numbers with a leading zero to yield a two-digit entry (00, 04-16).
4. Complete the programming sequence by scanning the ENTER/EXIT Programming Mode bar code.



Set MSI Length 2



Default setting for this feature = 16

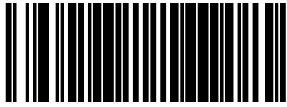

Enter/Exit Programming Mode

MSI Stitching

Enables/disables stitching for MSI labels. When parts of an MSI barcode are presented to the scanner with this feature enabled, the barcode parts will be assembled by the scanner's software, and the data will be decoded if all barcode proofing requirements are met.

To set this feature:

1. Scan the ENTER/EXIT Programming Mode bar code.
2. Scan your selection from the barcodes below. You'll need to cover any unused barcodes on this and the facing page to ensure that the scanner reads only the barcode you intend to scan.
3. Complete the programming sequence by scanning the ENTER/EXIT Programming Mode bar code.

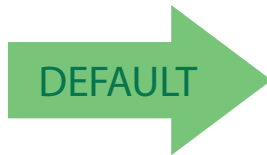

MSI Stitching = Disable



MSI Stitching = Enable



Standard 2 of 5 Enable

Enables/disables the ability of the scanner to decode Standard 2 of 5 labels.

To set this feature:

1. Scan the ENTER/EXIT Programming Mode bar code.
2. Scan either the enable or disable barcode below. You'll need to cover any unused barcodes on this and the facing page to ensure that the scanner reads only the barcode you intend to scan.
3. Complete the programming sequence by scanning the ENTER/EXIT Programming Mode bar code.

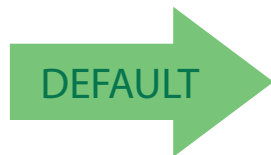

Standard 2 of 5 = Disable



Standard 2 of 5 = Enable

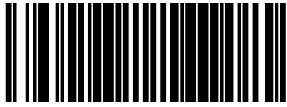

Standard 2 of 5 Check Character Calculation

Enables/disables calculation and verification of an optional Standard 2 of 5 check character.



If check character calculation is disabled, the risk is increased that a misread can occur. When disabled, any check character in a barcode is treated as data character.

NOTE

To set this feature:

1. Scan the ENTER/EXIT Programming Mode bar code.
2. Scan either the enable or disable barcode below. You'll need to cover any unused barcodes on this and the facing page to ensure that the scanner reads only the barcode you intend to scan.
3. Complete the programming sequence by scanning the ENTER/EXIT Programming Mode bar code.

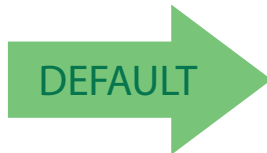

Standard 2 of 5 Check Character Calculation = Disable



Standard 2 of 5 Check Character Calculation = Enable



Standard 2 of 5 Check Character Transmission

Enables/disables transmission of an optional Standard 2 of 5 check character.



This feature applies only when Standard 2 of 5 Check Character Calculation is enabled. This item is ignored when the advanced feature, Full Label Edit, is enabled.

NOTE

To set this feature:

1. Scan the ENTER/EXIT Programming Mode bar code.
2. Scan either the enable or disable barcode below. You'll need to cover any unused barcodes on this and the facing page to ensure that the scanner reads only the barcode you intend to scan.
3. Complete the programming sequence by scanning the ENTER/EXIT Programming Mode bar code.



Standard 2 of 5 Check Character Transmission = Disable



Standard 2 of 5 Check Character Transmission = Enable





Standard 2 of 5 Minimum Read

This feature specifies the minimum number of consecutive Standard 2 of 5 decodes before is accepted as good read.

To set this feature:

1. Scan the ENTER/EXIT Programming Mode bar code.
2. Scan your selection from the bar codes below. You'll need to cover any unused bar codes on this and the facing page to ensure that the scanner reads only the bar code you intend to scan.
3. Complete the programming sequence by scanning the ENTER/EXIT Programming Mode bar code.

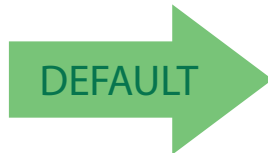

Standard 2 of 5 Minimum Read = 1



Standard 2 of 5 Minimum Read = 2



Standard 2 of 5 Minimum Read = 3



Standard 2 of 5 Minimum Read = 4



Standard 2 of 5 Correlation

Enables/disables character correlation for Standard 2 of 5.

To set this feature:

1. Scan the ENTER/EXIT Programming Mode bar code.
2. Scan either the enable or disable barcode below. You'll need to cover any unused barcodes on this and the facing page to ensure that the scanner reads only the barcode you intend to scan.
3. Complete the programming sequence by scanning the ENTER/EXIT Programming Mode bar code.

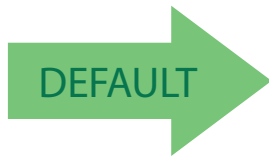

Standard 2 of 5 Correlation = Disable



Standard 2 of 5 Correlation = Enable

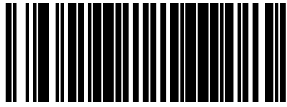

Standard 2 of 5 Length Control

This feature specifies whether variable-length or fixed-length decoding will be set for Standard 2 of 5.

To set this feature:

1. Scan the ENTER/EXIT Programming Mode bar code.
2. Scan your selection from the barcodes below. You'll need to cover any unused barcodes on this and the facing page to ensure that the scanner reads only the barcode you intend to scan.
3. Complete the programming sequence by scanning the ENTER/EXIT Programming Mode bar code.

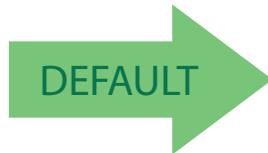

Standard 2 of 5 Length Control = Variable Length



Standard 2 of 5 Length Control = Fixed Length



Standard 2 of 5 Length 1

If Standard 2 of 5 Length Control is set to Fixed-Length decoding, this feature specifies Standard 2 of 5 first fixed length. If Standard 2 of 5 Length Control is set to Variable-Length decoding, this feature specifies the minimum label length.

To set this feature:

1. Scan the ENTER/EXIT Programming Mode bar code.
2. Scan the barcode, [Set Standard 2 of 5 Length 1](#) below. You'll need to cover any unused barcodes on this and the facing page to ensure that the scanner reads only the barcode you intend to scan.
3. Scan the appropriate digits from the [Keypad](#) in [Appendix C](#) that represent the desired label length. The selectable range for this option is 1 to 50. Pad all single digit numbers with a leading zero to yield a two-digit entry (01-50).
4. Complete the programming sequence by scanning the ENTER/EXIT Programming Mode bar code.



Set Standard 2 of 5 Length 1



Default setting for this feature = 08

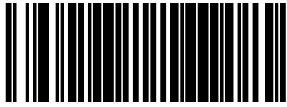

Standard 2 of 5 Length 2

If Standard 2 of 5 Length Control is set to Fixed-Length decoding, this feature specifies Standard 2 of 5 second fixed length. If Standard 2 of 5 Length Control is set to Variable-Length decoding, this feature specifies the maximum label length.



When in Fixed Length mode, if Length 2 is set to the value of 00 (zero), then only Length 1 will apply.

NOTE

To set this feature:

1. Scan the ENTER/EXIT Programming Mode bar code.
2. Scan the barcode, [Set Standard 2 of 5 Length 2](#) below. You'll need to cover any unused barcodes on this and the facing page to ensure that the scanner reads only the barcode you intend to scan.
3. Scan the appropriate digits from the [Keypad](#) in [Appendix C](#) that represent the desired label length. The selectable range for this option is 1 to 50. Pad all single digit numbers with a leading zero to yield a two-digit entry (01-50).
4. Complete the programming sequence by scanning the ENTER/EXIT Programming Mode bar code.



Set Standard 2 of 5 Length 2

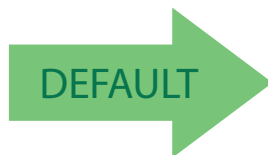

Default setting for this feature = 50



Standard 2 of 5 Stitching

Enables/disables stitching for Standard 2 of 5 labels. When parts of a Standard 2 of 5 barcode are presented to the scanner with this feature enabled, the barcode parts will be assembled by the scanner's software, and the data will be decoded if all barcode proofing requirements are met.



This applies when Standard 2 of 5 Length Control is set to fixed-length decoding.

NOTE

To set this feature:

1. Scan the ENTER/EXIT Programming Mode bar code.
2. Scan your selection from the barcodes below. You'll need to cover any unused barcodes on this and the facing page to ensure that the scanner reads only the barcode you intend to scan.
3. Complete the programming sequence by scanning the ENTER/EXIT Programming Mode bar code.

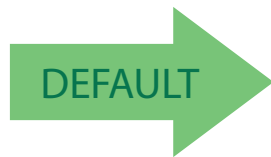

Standard 2 of 5 Stitching = Disable



Standard 2 of 5 Stitching = Enable



Enter/Exit Programming Mode

NOTES

Chapter 14

2D Symbology Programming

2D Symbologies



NOTE

If the scanner's interface type must be changed, always be sure that interface configuration is the **FIRST** item scanned during a programming session. (Selecting an interface type resets **ALL** other configuration items — including symbology programming — to the factory default for that interface type.)

The following pages contain configuration information concerning the various 2D bar code types (symbologies) the scanner supports.

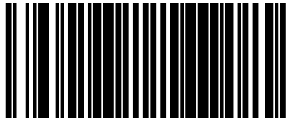

Data Matrix Enable

Enables/disables the ability of the scanner to decode Data Matrix labels.

To set this feature:

1. Scan the Enter/Exit Programming Mode bar code.
2. Scan either the enable or disable bar code below. You'll need to cover any unused bar codes on this and the facing page to ensure that the scanner reads only the bar code you intend to scan.
3. Complete the programming sequence by scanning the Enter/Exit Programming Mode bar code.

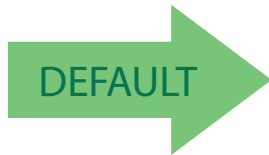

Data Matrix = Disable



Data Matrix = Enable



Data Matrix Length Control

Fixed Length Decoding — When fixed length decoding is enabled, the scanner will decode a bar code if the label length matches one of the configurable fixed lengths.

Variable Length Decoding — When variable length decoding is enabled, the scanner will decode a bar code if the label length falls in the range of the configurable minimum and maximum length.

Configuring Fixed Length Decoding:

1. Scan the ENTER/EXIT Programming Mode bar code.
2. Scan the Fixed Length Decoding bar code.
3. Scan the ENTER/EXIT Programming Mode bar code.
4. Set Length 1 to the first fixed length using the [Data Matrix Length 1, Length 2 Programming Instructions](#) that follow this page.
5. Set Length 2 to the second fixed length (or to '0000' if there is only one fixed length) using the [Data Matrix Length 1, Length 2 Programming Instructions](#).

Configuring Variable Length Decoding:

1. Scan the ENTER/EXIT Programming Mode bar code.
2. Scan the Variable Length Decoding bar code.
3. Scan the ENTER/EXIT Programming Mode bar code.
4. Set Length 1 to the minimum length using the [Data Matrix Length 1, Length 2 Programming Instructions](#) that follow this page.
5. Set Length 2 to the maximum length using the [Data Matrix Length 1, Length 2 Programming Instructions](#).

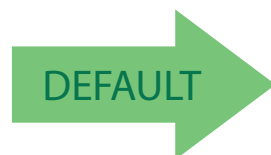

Data Matrix Length Control = Variable Length



Data Matrix Length Control = Fixed Length

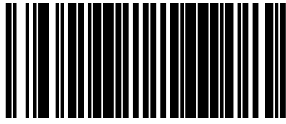

Data Matrix Length 1, Length 2 Programming Instructions

If Data Matrix Length Control is set to Fixed-Length decoding, this feature specifies Data Matrix first fixed length. If Data Matrix Length Control is set to Variable-Length decoding, this feature specifies the minimum label length.



For Data Matrix bar codes, only the data characters are included in the length calculations.

NOTE

To set this feature:

1. Scan the ENTER/EXIT Programming Mode bar code.
2. Scan the barcode, [Set Data Matrix Length 1](#) or [Set Data Matrix Length 2](#) below. You'll need to cover any unused barcodes on this and the facing page to ensure that the scanner reads only the bar code you intend to scan.
3. Scan the appropriate digits from the [Keypad](#) in [Appendix C](#) that represent the desired label length. The selectable range for this option is 0001 to 3116. Pad all numbers with leading zeros to yield a four-digit entry (0001-3116).
4. Complete the programming sequence by scanning the ENTER/EXIT Programming Mode bar code.

Default setting for this feature = 0001



Set Data Matrix Length 1



Set Data Matrix Length 2

Default setting for this feature = 0800



PDF 417 Enable

Enable the processing of PDF417 labels read by a handheld scanner attached to the auxiliary port.

To set this feature:

1. Scan the Enter/Exit Programming Mode bar code.
2. Scan either the enable or disable bar code below. You'll need to cover any unused bar codes on this and the facing page to ensure that the scanner reads only the bar code you intend to scan.
3. Complete the programming sequence by scanning the Enter/Exit Programming Mode bar code.



PDF 417 = Disable



PDF 417 = Enable



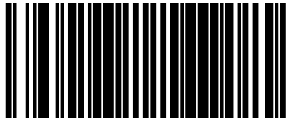

PDF 417 Length Control

Fixed Length Decoding — When fixed length decoding is enabled, the scanner will decode a bar code if the label length matches one of the configurable fixed lengths.

Variable Length Decoding — When variable length decoding is enabled, the scanner will decode a bar code if the label length falls in the range of the configurable minimum and maximum length.

Configuring Fixed Length Decoding:

1. Scan the ENTER/EXIT Programming Mode bar code.
2. Scan the Fixed Length Decoding bar code.
3. Scan the ENTER/EXIT Programming Mode bar code.
4. Set Length 1 to the first fixed length using the [PDF 417 Length 1, Length 2 Programming Instructions](#) that follow this page.
5. Set Length 2 to the second fixed length (or to '0000' if there is only one fixed length) using the [PDF 417 Length 1, Length 2 Programming Instructions](#).

Configuring Variable Length Decoding:

1. Scan the ENTER/EXIT Programming Mode bar code.
2. Scan the Variable Length Decoding bar code.
3. Scan the ENTER/EXIT Programming Mode bar code.
4. Set Length 1 to the minimum length using the [PDF 417 Length 1, Length 2 Programming Instructions](#) that follow this page.
5. Set Length 2 to the maximum length using the [PDF 417 Length 1, Length 2 Programming Instructions](#).

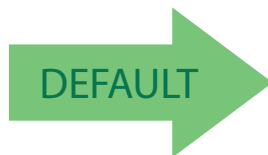

PDF 417 Length Control = Variable Length



PDF 417 Length Control = Fixed Length



PDF 417 Length 1, Length 2 Programming Instructions

If PDF417 Length Control is set to Fixed-Length decoding, this feature specifies PDF417 first fixed length. If PDF417 Length Control is set to Variable-Length decoding, this feature specifies the minimum label length.



NOTE

This tag is only valid for units with a model id that supports PDF.

Length 1 is the minimum label length if in variable length mode, or the first fixed length if in fixed length mode. Length 2 is the maximum label length if in variable length mode, or the second fixed length if in fixed length mode. Length includes the barcode's data characters only. Any value > 2710 will be considered to be 2710.

To set this feature:

1. Scan the ENTER/EXIT Programming Mode bar code.
2. Scan the barcode, [Set PDF 417 Length 1](#) or [Set PDF 417 Length 2](#) below. You'll need to cover any unused barcodes on this and the facing page to ensure that the scanner reads only the bar code you intend to scan.
3. Scan the appropriate digits from the [Keypad in Appendix C](#) that represent the desired label length. The selectable range for this option is 0001 to 2710. Pad all numbers with leading zeros to yield a four-digit entry (0001-2710).
4. Complete the programming sequence by scanning the ENTER/EXIT Programming Mode bar code.

Default setting for this feature = 0001



Set PDF 417 Length 1



Set PDF 417 Length 2

Default setting for this feature = 2710

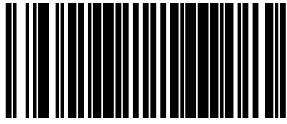

PDF 417 Read Option

This feature specifies an additional read control option for PDF 417 bar codes.

To set this feature:

1. Scan the Enter/Exit Programming Mode bar code.
2. Scan either the enable or disable bar code below. You'll need to cover any unused bar codes on this and the facing page to ensure that the scanner reads only the bar code you intend to scan.
3. Complete the programming sequence by scanning the Enter/Exit Programming Mode bar code.

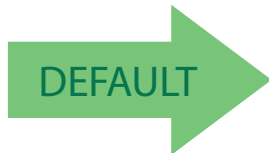

PDF 417 Read Option = None



PDF 417 Read Option = Turn Off Codeword
Length Checking



Micro PDF 417 Enable

Enables/disables the ability of the scanner to decode Micro PDF 417 labels.

To set this feature:

1. Scan the Enter/Exit Programming Mode bar code.
2. Scan either the enable or disable bar code below. You'll need to cover any unused bar codes on this and the facing page to ensure that the scanner reads only the bar code you intend to scan.
3. Complete the programming sequence by scanning the Enter/Exit Programming Mode bar code.

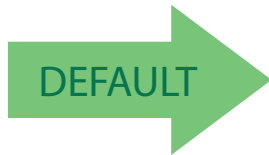

Micro PDF 417 = Disable



Micro PDF 417 = Enable

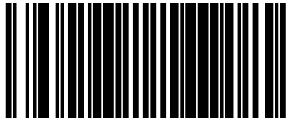

Micro PDF 417 Length Control

Fixed Length Decoding — When fixed length decoding is enabled, the scanner will decode a bar code if the label length matches one of the configurable fixed lengths.

Variable Length Decoding — When variable length decoding is enabled, the scanner will decode a bar code if the label length falls in the range of the configurable minimum and maximum length.

Configuring Fixed Length Decoding:

1. Scan the ENTER/EXIT Programming Mode bar code.
2. Scan the Fixed Length Decoding bar code.
3. Scan the ENTER/EXIT Programming Mode bar code.
4. Set Length 1 to the first fixed length using the [Micro PDF 417 Length 1, Length 2 Programming Instructions](#) that follow this page.
5. Set Length 2 to the second fixed length (or to '0000' if there is only one fixed length) using the [Micro PDF 417 Length 1, Length 2 Programming Instructions](#).

Configuring Variable Length Decoding:

1. Scan the ENTER/EXIT Programming Mode bar code.
2. Scan the Variable Length Decoding bar code.
3. Scan the ENTER/EXIT Programming Mode bar code.
4. Set Length 1 to the minimum length using the [Micro PDF 417 Length 1, Length 2 Programming Instructions](#) that follow this page.
5. Set Length 2 to the maximum length using the [Micro PDF 417 Length 1, Length 2 Programming Instructions](#).

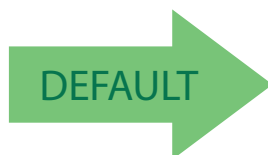

Micro PDF 417 Length Control = Variable Length



Micro PDF 417 Length Control = Fixed Length



Micro PDF 417 Length 1, Length 2 Programming Instructions

If Micro PDF 417 Length Control is set to Fixed-Length decoding, this feature specifies Micro PDF 417 first fixed length. If Micro PDF 417 Length Control is set to Variable-Length decoding, this feature specifies the minimum label length.



NOTE

This tag is only valid for units with a model ID that supports PDF.

Length 1 is the minimum label length if in variable length mode, or the first fixed length if in fixed length mode. Length 2 is the maximum label length if in variable length mode, or the second fixed length if in fixed length mode. Length includes the barcode's data characters only. Any value > 0366 will be considered to be 0366.

To set this feature:

1. Scan the ENTER/EXIT Programming Mode bar code.
2. Scan the barcode, [Set Micro PDF 417 Length 1](#) or [Set Micro PDF 417 Length 2](#) below. You'll need to cover any unused barcodes on this and the facing page to ensure that the scanner reads only the bar code you intend to scan.
3. Scan the appropriate digits from the [Keypad in Appendix C](#) that represent the desired label length. The selectable range for this option is 0001 to 0366. Pad all numbers with leading zeros to yield a four-digit entry (0001-0366).
4. Complete the programming sequence by scanning the ENTER/EXIT Programming Mode bar code.

Default setting for this feature = 0001



Set Micro PDF 417 Length 1



Set Micro PDF 417 Length 2

Default setting for this feature = 0366

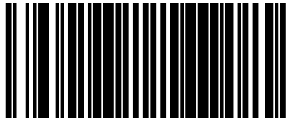

Enter/Exit Programming Mode

Micro PDF 417 128 Emulation

This feature specifies which AIM ID to use for Micro PDF 417 labels when performing Code 128 or EAN 128 emulation.

To set this feature:

1. Scan the Enter/Exit Programming Mode bar code.
2. Scan the bar code below for the desired setting. You'll need to cover any unused bar codes on this and the facing page to ensure that the scanner reads only the bar code you intend to scan.
3. Complete the programming sequence by scanning the Enter/Exit Programming Mode bar code.

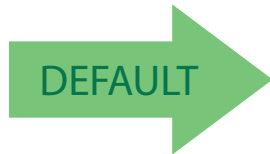

Micro PDF 417 128 Emulation = Micro PDF AIM ID and label type when emulating EAN128 or Code 128



Micro PDF 417 128 Emulation = Code 128 / EAN128 AIM ID and label type when emulating EAN128 or Code 128



QR Code Enable

Enables/disables the ability of the scanner to decode QRCode labels.

To set this feature:

1. Scan the Enter/Exit Programming Mode bar code.
2. Scan either the enable or disable bar code below. You'll need to cover any unused bar codes on this and the facing page to ensure that the scanner reads only the bar code you intend to scan.
3. Complete the programming sequence by scanning the Enter/Exit Programming Mode bar code.

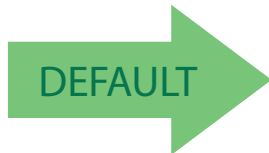

QR Code = Disable



QR Code = Enable

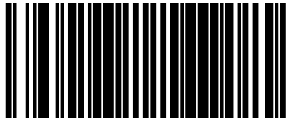

QR Code Length Control

Fixed Length Decoding — When fixed length decoding is enabled, the scanner will decode a bar code if the label length matches one of the configurable fixed lengths.

Variable Length Decoding — When variable length decoding is enabled, the scanner will decode a bar code if the label length falls in the range of the configurable minimum and maximum length.

Configuring Fixed Length Decoding:

1. Scan the ENTER/EXIT Programming Mode bar code.
2. Scan the Fixed Length Decoding bar code.
3. Scan the ENTER/EXIT Programming Mode bar code.
4. Set Length 1 to the first fixed length using the [QR Code Length 1, Length 2 Programming Instructions](#) that follow this page.
5. Set Length 2 to the second fixed length (or to '0000' if there is only one fixed length) using the [QR Code Length 1, Length 2 Programming Instructions](#).

Configuring Variable Length Decoding:

1. Scan the ENTER/EXIT Programming Mode bar code.
2. Scan the Variable Length Decoding bar code.
3. Scan the ENTER/EXIT Programming Mode bar code.
4. Set Length 1 to the minimum length using the [QR Code Length 1, Length 2 Programming Instructions](#) that follow this page.
5. Set Length 2 to the maximum length using the [QR Code Length 1, Length 2 Programming Instructions](#).

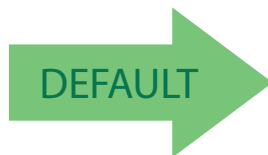

QR Code Length Control = Variable Length



QR Code Length Control = Fixed Length



QR Code Length 1, Length 2 Programming Instructions

If QR Code Length Control is set to Fixed-Length decoding, this feature specifies QR Code first fixed length. If QR Code Length Control is set to Variable-Length decoding, this feature specifies the minimum label length.



NOTE

Length 1 is the minimum label length if in variable length mode, or the first fixed length if in fixed length mode. Length 2 is the maximum label length if in variable length mode, or the second fixed length if in fixed length mode. Length includes the barcode's data characters only. Any value > 2710 will be considered to be 2710.

To set this feature:

1. Scan the ENTER/EXIT Programming Mode bar code.
2. Scan the barcode, [Set QR Code Length 1](#) or [Set QR Code Length 2](#) below. You'll need to cover any unused barcodes on this and the facing page to ensure that the scanner reads only the bar code you intend to scan.
3. Scan the appropriate digits from the [Keypad in Appendix C](#) that represent the desired label length. The selectable range for this option is 0001 to 2710. Pad all numbers with leading zeros to yield a four-digit entry (001-02710).
4. Complete the programming sequence by scanning the ENTER/EXIT Programming Mode bar code.

Default setting for this feature = 0001



Set QR Code Length 1



Set QR Code Length 2

Default setting for this feature = 2710

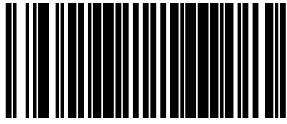

Enter/Exit Programming Mode

Micro QR Code Enable

Enables/disables the ability of the scanner to decode Micro QRCode labels.

To set this feature:

1. Scan the Enter/Exit Programming Mode bar code.
2. Scan either the enable or disable bar code below. You'll need to cover any unused bar codes on this and the facing page to ensure that the scanner reads only the bar code you intend to scan.
3. Complete the programming sequence by scanning the Enter/Exit Programming Mode bar code.

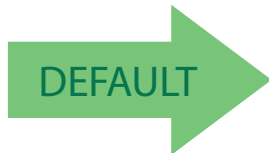

Micro QR Code = Disable



Micro QR Code = Enable



Micro QR Code Length Control

Fixed Length Decoding — When fixed length decoding is enabled, the scanner will decode a bar code if the label length matches one of the configurable fixed lengths.

Variable Length Decoding — When variable length decoding is enabled, the scanner will decode a bar code if the label length falls in the range of the configurable minimum and maximum length.

Configuring Fixed Length Decoding:

1. Scan the ENTER/EXIT Programming Mode bar code.
2. Scan the Fixed Length Decoding bar code.
3. Scan the ENTER/EXIT Programming Mode bar code.
4. Set Length 1 to the first fixed length using the [Micro QR Code Length 1, Length 2 Programming Instructions](#) that follow this page.
5. Set Length 2 to the second fixed length (or to '0000' if there is only one fixed length) using the [Micro QR Code Length 1, Length 2 Programming Instructions](#).

Configuring Variable Length Decoding:

1. Scan the ENTER/EXIT Programming Mode bar code.
2. Scan the Variable Length Decoding bar code.
3. Scan the ENTER/EXIT Programming Mode bar code.
4. Set Length 1 to the minimum length using the [Micro QR Code Length 1, Length 2 Programming Instructions](#) that follow this page.
5. Set Length 2 to the maximum length using the [Micro QR Code Length 1, Length 2 Programming Instructions](#).



Micro QR Code Length Control = Variable Length



Micro QR Code Length Control = Fixed Length

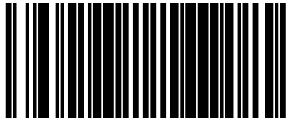

Micro QR Code Length 1, Length 2 Programming Instructions

If Micro QR Code Length Control is set to Fixed-Length decoding, this feature specifies Micro QR Code first fixed length. If Micro QR Code Length Control is set to Variable-Length decoding, this feature specifies the minimum label length.



NOTE

Length 1 is the minimum label length if in variable length mode, or the first fixed length if in fixed length mode. Length 2 is the maximum label length if in variable length mode, or the second fixed length if in fixed length mode. Length includes the barcode's data characters only. Any value > 3700 will be considered to be 3700.

To set this feature:

1. Scan the ENTER/EXIT Programming Mode bar code.
2. Scan the barcode, [Set Aztec Length 1](#) or [Set Micro QR Code Length 2](#) below. You'll need to cover any unused barcodes on this and the facing page to ensure that the scanner reads only the bar code you intend to scan.
3. Scan the appropriate digits from the [Keypad in Appendix C](#) that represent the desired label length. The selectable range for this option is 0001 to 3700. Pad all numbers with leading zeros to yield a four-digit entry (0001-3700).
4. Complete the programming sequence by scanning the ENTER/EXIT Programming Mode bar code.

Default setting for this feature = 0001



Set Micro QR Code Length 1



Set Micro QR Code Length 2

Default setting for this feature = 3700



Aztec Enable

Enables/disables the ability of the scanner to decode Aztec labels.

To set this feature:

1. Scan the Enter/Exit Programming Mode bar code.
2. Scan either the enable or disable bar code below. You'll need to cover any unused bar codes on this and the facing page to ensure that the scanner reads only the bar code you intend to scan.
3. Complete the programming sequence by scanning the Enter/Exit Programming Mode bar code.

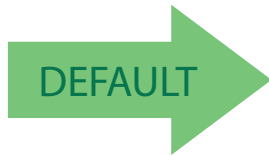

Aztec = Disable



Aztec = Enable

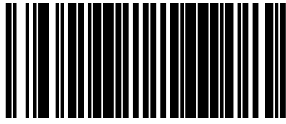

Aztec Length Control

Fixed Length Decoding — When fixed length decoding is enabled, the scanner will decode a bar code if the label length matches one of the configurable fixed lengths.

Variable Length Decoding — When variable length decoding is enabled, the scanner will decode a bar code if the label length falls in the range of the configurable minimum and maximum length.

Configuring Fixed Length Decoding:

1. Scan the ENTER/EXIT Programming Mode bar code.
2. Scan the Fixed Length Decoding bar code.
3. Scan the ENTER/EXIT Programming Mode bar code.
4. Set Length 1 to the first fixed length using the [Aztec Length 1, Length 2 Programming Instructions](#) that follow this page.
5. Set Length 2 to the second fixed length (or to '0000' if there is only one fixed length) using the [Aztec Length 1, Length 2 Programming Instructions](#).

Configuring Variable Length Decoding:

1. Scan the ENTER/EXIT Programming Mode bar code.
2. Scan the Variable Length Decoding bar code.
3. Scan the ENTER/EXIT Programming Mode bar code.
4. Set Length 1 to the minimum length using the [Aztec Length 1, Length 2 Programming Instructions](#) that follow this page.
5. Set Length 2 to the maximum length using the [Aztec Length 1, Length 2 Programming Instructions](#).

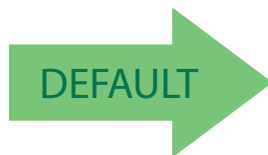

Aztec Length Control = Variable Length



Aztec Length Control = Fixed Length



Aztec Length 1, Length 2 Programming Instructions

If Aztec Length Control is set to Fixed-Length decoding, this feature specifies Aztec first fixed length. If Aztec Length Control is set to Variable-Length decoding, this feature specifies the minimum label length.



NOTE

Length 1 is the minimum label length if in variable length mode, or the first fixed length if in fixed length mode. Length 2 is the maximum label length if in variable length mode, or the second fixed length if in fixed length mode. Length includes the barcode's data characters only. Any value > 3700 will be considered to be 3700.

To set this feature:

1. Scan the ENTER/EXIT Programming Mode bar code.
2. Scan the barcode, [Set Aztec Length 1](#) or [Set Aztec Length 2](#) below. You'll need to cover any unused barcodes on this and the facing page to ensure that the scanner reads only the bar code you intend to scan.
3. Scan the appropriate digits from the [Keypad in Appendix C](#) that represent the desired label length. The selectable range for this option is 0001 to 3700. Pad all numbers with leading zeros to yield a four-digit entry (0001-3700).
4. Complete the programming sequence by scanning the ENTER/EXIT Programming Mode bar code.

Default setting for this feature = 0001



Set Aztec Length 1



Set Aztec Length 2

Default setting for this feature = 3700

NOTES

Appendix A

LED/Audio Indications & Controls

Good Read Indicators

The scanner features two prominent LED indicator bars on top of its vertical “bonnet” (item #2 in [Figure 57](#)) as well as another highly visible LED indicator for indicating Mobile Commerce reading activities atop the Top Down Reader (if a TDR is present) which is item #1 in [Figure 57](#).

Figure 57. Scanner and Scale Controls

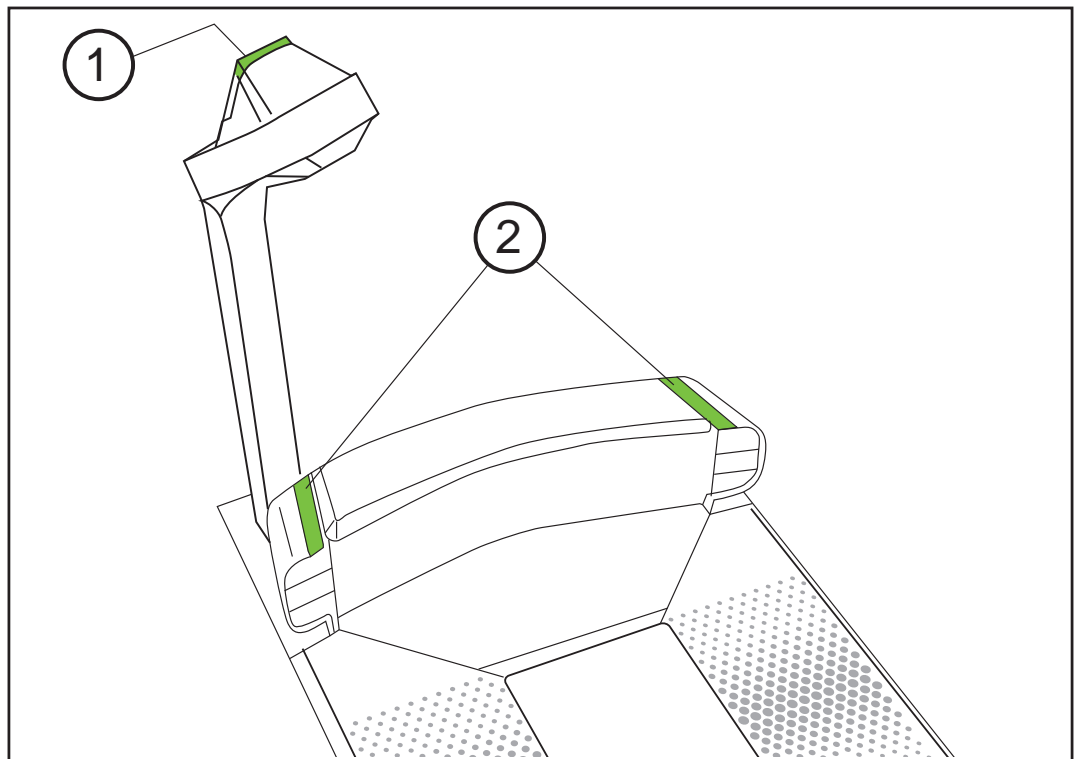









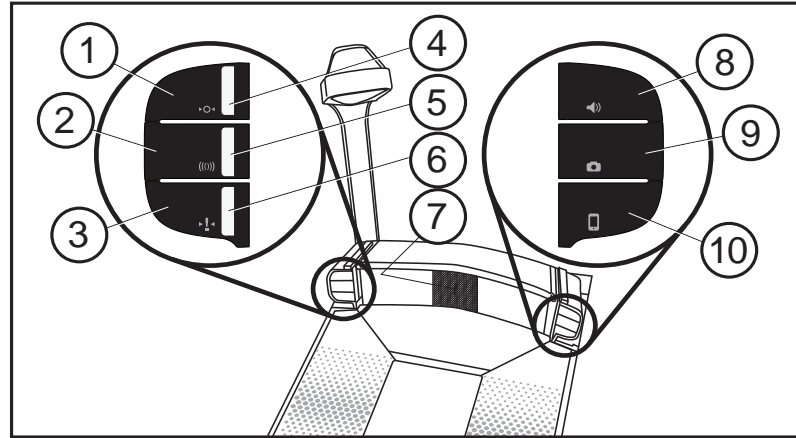

1	Mobile Commerce Indicator LED (option)	2	Good Read Indicator Bars
---	--	---	--------------------------

Controls and Indicators

As [Figure 58](#) illustrates, two panels on either side of the vertical scan windows contain control buttons and more LED indicators. Additionally, a configurable speaker is used to sound scanning, weighing and EAS deactivation indications.

Figure 58. Control Buttons and Indicator LEDs



1	Scale Zero Button	6	ScaleSentry Indicator LED (Red)
▶◀	With all weight removed from the scale, push this button to set the scale to zero.	 This LED indicates the current ScaleSentry condition. See the LED and Beeper Indications section for more information.	
((()))	Manual EAS Deactivation Button	7	Speaker
	When in EAS Manual Deactivation Mode, push this button to deactivate an item.	 Sounds ^a beeps, error tones and other audible signals to indicate good read, ScaleSentry alert, system error and other conditions.	
▶!▶	ScaleSentry / Scale Service Button	8	Scanner Control Button
	Performs ScaleSentry and Scale Service functions depending on the duration of the button press. See the topic ScaleSentry / Scale Service Button , in this section for more information.	 See the topic Scanner Control Button , in this section for more information.	
	Scale Indicator LED (Yellow)	9	Camera Button
	This LED indicates scale functions. See the Indicator Table for more information.	 Press this button to place the scanner in Camera Mode and to take pictures with the configured imager (either the Top Down Reader [TDR] or the Mobile Commerce Reader).	
	EAS Indicator LED (Red/Green/Orange)	10	Mobile Commerce Button
	This LED indicates EAS functions with red, green OR orange color. See the Indicator Table for more information.	 Press this button to place the scanner in Mobile Commerce state. Bar code(s) can be read by the Mobile Commerce Reader while in this state.	

^a. Some audible indications are configurable to be on or off, as well as offer their own programmable options for pitch, volume, etc.











Since audio indications are configurable, your unit may not be programmed to sound all the indications as listed. For more information, see the [Programming](#) section of this manual.

LED and Audio Indications

Scanner and Scale LEDs

The Green Good Read indicator bars (see item #2 in [Figure 57](#)) indicate scanner status, and the Scale LED (see item #4 in [Figure 58](#)) is primarily used to show scale status (see [Table 15](#)).

Table 15. Scanner and Scale LED Indications

LED INDICATION	DURATION	COMMENT
Scale at Zero ^a	Scale (Yellow) LED on steady 	The scale is at rest and reads zero weight. The scale is ready to weigh.
Scanner Active ^a (Normal Mode)	Scanner (Green) LED on steady and dim 	The scanner is ready for operation. Scanning is immediately available.
Good Read Indication ^a	Scanner (Green) LED - bright flash 	Indicates a bar code has been read and decoded.
Program Mode Indication	Scanner (Green) LED - Continuous flashing 	Indicates the scanner is in Label Programming Mode. Cycle power (or read an Exit Programming label) to exit Programming Mode.
Sleep Mode Indication	Scanner (Green) LED flashes slowly 10ms on, 1990ms off. 	The scanner has automatically switched off and the unit has entered Sleep Mode due to extended inactivity.
Scanner Disabled ^a	Scanner (Green) LED blinks 100ms on, 900ms off. 	Host has disabled scanning.
Field Replaceable Unit (FRU) Warning (Error Mode)	Audible low tone 1 second. Alternating Scanner/Scale /EAS and ScaleSentry LEDs flash continuously ^b . 	Serves notice that a fatal FRU failure has been detected. Consult in this manual for more details.
FRU Indication	Scanner (Green) LED flashes a coded sequence in concert with the speaker. 	Occurs ONLY upon Volume/Tone button push following a FRU warning. Enables service technicians to identify FRU failures.
ROM Failure	Scanner (Green) LED - Continuous flashing 200ms on, 200ms off. 	Indicates Boot ROM failure or Program ROM failure.

a. Certain functions of the Green and Yellow LEDs are selectable to be enabled or disabled. Your scanner may not be programmed to display all indications.

b. For FRU error 9, the Deactivator LED (tri-color) is off.

Audio Indications

The speaker (beeper) mounted in the scanner's bonnet will beep or sound other audio indications to announce scanning, weighing, errors or other functions (see [Table 16](#)). Beep indications specific to Electronic Article Surveillance (EAS) are listed in the next section.



The indications listed below are the factory default settings. Your scanner may have been configured with different beeper settings. For example, certain beeper indications may be turned off.

NOTE

Table 16. Audio Indications

AUDIO INDICATION	DESCRIPTION OF SOUND	COMMENT
Power-up tone	Unique WAV file sound. Synthesized tones ending with two bell sounds.	Indicates the scanner is powering-on.
Good Read Beep	One beep at current frequency and volume.	The duration of the beep is also at the current setting.
ROM Failure	One 200ms error beep at low frequency.	Indicates Boot ROM or Program ROM failure.
Chirp Indications	Six "Chirps" at highest frequency and current volume.	A "Chirp" is used to indicate the following: -Reading labels while in limited scanning mode. -Label rejection during label programming. -A label with no data. -Labels rejected through the auxiliary port when in Scanner Diagnostics Mode.
Bootload Entry Indications	The beeper sounds a series of beeps at highest frequency and current volume to indicate various	See Error Codes in the Problem Isolation section for more details.
Null Interface Selected	40 error beeps at highest volume, 20ms ON and 20 ms OFF.	This means that no interface has been selected. Refer to the Programming section for interface configuration information.
Insert microSD Card	Unique WAV file sound. Similar to a high-pitched plucked string.	This sound occurs upon a microSD Card being installed in the microSD slot. Click the icon in the left column to hear the sound.
Eject microSD Card	Unique WAV file sound. Similar to a medium-pitched plucked string.	Indicates that a microSD Card has been removed from the microSD Card slot. Click the icon in the left column to hear the sound.

Deactivator LED

The tri-color Deactivator LED (item #5 in [Figure 58](#)) designates EAS deactivation status (see [Table 17](#)). The table also provides information about special beeper indications which can be sounded in response to changes in deactivation status.

Table 17. EAS Indications

















EAS DEACTIVATION DISABLED			
INDICATION	LED DURATION	EAS BEEPER	COMMENT
Deactivation Disabled	Deactivation (Tri-color) LED is OFF	OFF	Deactivation mode must be selected via programming. Reference EAS Mode .
ALL MODES (COUPLED, DECOUPLED, HYBRID or HOST)			
Deactivation Ready	Deactivation (Tri-color) LED is lit steadily Green. 	OFF	Deactivation is ready.
EAS tag Detected	Deactivation (Tri-color) LED flashes Red. 	OFF	An EAS tag has been sensed in the scan volume.
Power-up Initialization	Deactivation (Tri-color) LED ^a blinks ON/OFF Red. 	OFF	System is attempting to initialize EAS
EAS Error	Deactivation (Tri-color) LED flashes Red while FRU Status LED flashes error code nine (9). 	Low frequency beep (1 second) 	EAS system is not on line.
COUPLED MODE ONLY			
Deactivation Indicated	Deactivation (Tri-color) LED flashes Red, then Orange, then returns to Green. 	Good read beep follows deactivation. 	The EAS antenna has been triggered ON to deactivate a label following successful bar code read.
Manual Deactivation in Progress	Deactivation (Tri-color) LED is lit steadily Green. 	Ticking sound (for configurable duration) 	The Manual EAS Deactivation Push Button was pressed & released ^b .
Manual Deactivation Successful	Deactivation (Tri-color) LED flashes Red, then Orange, then returns to Green. 	High frequency beep 	An EAS tag was successfully deactivated via manual push button.
Deactivate EAS System When Failed	Deactivation (Tri-color) LED is flashing slowly Red. FRU Status LED displays error code nine (9) 	Upon initiating this state (pressing EAS Button for 3 seconds): 3 high-pitched beeps 	Upon EAS malfunction/failure, scanning function can continue independent of EAS if the EAS button is held for 3 seconds.

Table 17. EAS Indications

DECOUPLLED MODE			
Deactivation Indicated	Deactivation (Tri-color) LED flashes Red. 	EAS Beep OFF	An EAS tag has been successfully deactivated.
HYBRID MODE			
Deactivation Indicated	Deactivation (Tri-color) LED flashes Red, then Orange, then returns to Green. 	High frequency beep 	An EAS tag has been successfully deactivated.

- a. Additionally, the FRU LED (Health & Status Indicator located in the bottom of the optic cavity — visible through the horizontal scan window) blinks the number '9'. If EAS deactivation fails to initiate, a low, error tone will be sounded, and the FRU LED will display the error code '9' steadily (without flashing).
- b. Ticking sound will stop upon one of the following: 1) Manual EAS Deactivation Push Button is pressed and released again, 2) EAS timer runs out, or 3) Following a successful EAS tag deactivation.

ScaleSentry / Scale Service Button

The ScaleSentry / Scale Service Button (item #3 in [Figure 58](#)) is used for multiple functions as listed in [Table 18](#).

Table 18. ScaleSentry / Scale Service Button Functions

PRESS DURATION	FUNCTION	COMMENT
Momentary	Override	If a ScaleSentry event is occurring, this will override the scale sentry event. If no ScaleSentry event is occurring, this will activate the manual tare function of the scale.
4 Seconds	Scale Diagnostics Mode ^a	This mode allows system support personnel to troubleshoot problems with the scale. Momentarily press the Scale Zero Button or cycle power to exit Scale Diagnostics Mode. See the topic, Scale Error Reporting in the Problem Isolation section for more details.
8 Seconds	Resets Scanner	Only system support personnel should perform a reset.
Momentary while in Scale Diagnostics Mode	Resets Scanner	A scanner reset can also be initiated by a momentary press of this button while in Scale Diagnostics Mode.

- a. Diagnostics Mode is meant for use by trained systems support personnel. Users should not need to initiate this function under normal circumstances.

Sensormatic EAS Button

The Sensormatic EAS Button (see item #2 in [Figure 58](#)) has configurable functions. Use the [Programming](#) section to configure the button to operate always, or only function when the scanner is enabled.

PRESS DURATION	FUNCTION	COMMENT
Momentary ^a	Manually initiates EAS deactivation	Place the item with the EAS tag downstream ^b of the horizontal scan window and push the button.
3 Seconds upon EAS error	Allows scanner to resume function despite EAS system failure (non-fatal error)	EAS Failure Mode is indicated ^c by: - EAS LED blinks ON/OFF red, scanning disabled. - FRU Status LED Indicator blinks '9' - Error tone is sounded for one second Upon pressing the button for 3 seconds, the scanner will sound 3 high-pitched beeps, then resume scan function. The EAS LED and FRU Status LED will continue blinking as above, but at a slower rate until EAS system function is restored.

- a. For use in Coupled Mode only
- b. "Downstream" in this case is defined as being the downstream side of the scan window from the direction of product flow, or scanning direction.
- c. If the EAS failure corrects itself, blinking will stop and the EAS LED will turn green.

Camera Button

The Camera Button (item #9 in [Figure 58](#)) is used for multiple functions as listed in [Table 19](#).

Table 19. Camera Button Functions

PRESS DURATION	FUNCTION	COMMENT
1st Momentary Press	Enables the Camera Function	Enables image capture mode for the unit.
2nd Momentary Press	Captures Image	Once in image capture mode, the second press captures the image.

Mobile Commerce Button

With a momentary press, the Mobile Commerce Button (item #10 in [Figure 58](#)) goes into and out of Mobile Commerce mode.

Scanner Control Button

The Scanner Control Button (item #8 in [Figure 58](#)) also performs multiple functions depending upon the duration of time it is pressed:



NOTE

Volume changes made using the Scanner Control Button are lost when the scanner is powered-down and are reset to the factory default setting. If you wish to permanently change the volume, use the special programming labels in the [Programming](#) section.

Table 20. Scanner Control Button Functions

PRESS DURATION	FUNCTION	COMMENT
Momentary (when scanner is asleep)	Wakes scanner from Sleep Mode	Alternatively, the scanner can be awakened by: <ul style="list-style-type: none"> - Moving an object through the scan zone. - A weight change on the scale. - Scanning with an attached auxiliary scanner.
Momentary (when scanner is awake)	Increments volume	Press the push button momentarily to increase speaker volume. When the loudest volume is reached, a repeated press of the push button cycles volume back to the lowest setting, then volume increases on subsequent press(es). Five volume levels are available.
5 to 9 Seconds	Scanner Diagnostics Mode ^a	This mode allows system support personnel to troubleshoot problems with the scanner. Upon entering Scanner Diagnostic Mode, view the Health & Status Indicator to view Interface Type, Bootloader Version Number, Application Version Number and Configuration File Number. This mode is used to determine if a scanner can read bar codes. Press the button for ten seconds or cycle power to exit Scanner Diagnostics Mode and reset the scanner.
10 Seconds	Resets Scanner ^b (soft reset)	Only system support personnel should perform a reset.

- a. By standard default, this function is normally disabled to prevent accidental activation by users.
- b. Users should not perform scanner resets except under the direction of trained systems support personnel.

Scale Zero Button

The Scale Zero Button (item #1 in [Figure 58](#)) is used for multiple functions as listed in [Table 21](#).



The Scale Zero Button has no function in a “scanner only” model.

NOTE

Table 21. Scale Zero Button Functions

PRESS DURATION	FUNCTION	COMMENT
Momentary	Zero Scale	When programmed to do so, the Scale Indicator LED (item#4 in Figure 58) should be lit when no weight is on the scale, indicating scale at zero. If it is not, press the switch to zero the scale. The unit will sound a “click” upon pressing the button.
8 Seconds	Resets Scanner	Only system support personnel should perform a reset.

Calibration Switch

This switch initiates the scale's calibration routine. A certified weight set is needed to perform the scale calibration steps detailed in [Chapter 6, Calibration Procedures](#). This switch is not included in scanners without scale modules.

Calibration Switch Seal

This seal allows you to secure the Calibration Switch access cover and restrict access to the Calibration Switch. If the calibration seal is broken or missing, you may be prohibited from operating the scale without recertification. Check local and state requirements for specific restrictions.

Calibration Switch Cover

This cover restricts access to the Calibration Switch to help guard against unauthorized tampering when sealed. See [Figure 59](#).

LEGAL NOTE

There are regulations that must be followed in order to ensure compliance when operating a weighing device such as the scanner/scale. Failure to observe and comply with these regulations could result in legal action.

LEGAL NOTE

Figure 59. Calibration Switch Cover

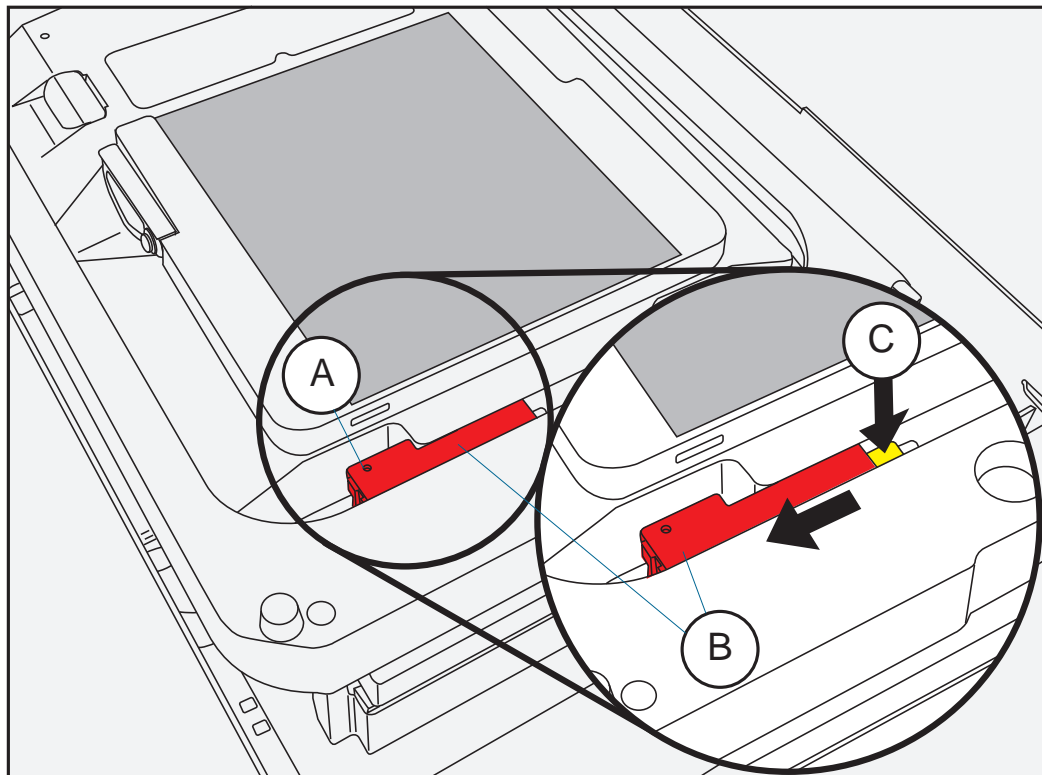

Appendix B

Cable Information

Introduction

The following pages contain pinout information, enabling you to create standard interface cables for use in interconnecting the scanner, scale, external handheld scanner, and POS terminal.

General Specifications

Wire Requirements

- Cable length should not exceed 15 feet.
- Wire gauge = Standard for RJ-45 connectors (28-26 AWG).
- 26 AWG wire size can improve performance for longer cables.

External Cable Pinouts

Connector Hardware RJ45, 10 Position

PIN	RS-232		IBM		AUXILIARY PORT		EAS COMM PORT	
	Scanner	Scale	IBM	IBM USB	External Input	Handheld	Sensormatic Control Box	
1	N/C	+5v pul-lup	N/C	USB D+	+5V pul-lup	+5V pul-lup	ERI OUT	
2	CTS in	Clear To Send (input)	N/C	No Connection	CTS in	Clear To Send (input)	VCC5	
3	N/C	No Connection	N/C	USB D-	N/C	No Connection	EAS LBL DEACT EN~	EAS Deactivation
4	RTS out	Request To Send (output)	LINE B	No Connection	RTS out	Request To Send (output)	SIGNAL GND	
5	RxD in	Receive Data (input)	N/C	No Connection	RxD out	Receive Data (input)	EAS LBL DETECT EN~	EAS tag Detect
6	TxD out	Transmit Data (output)	LINE A	No Connection	TxD out	Transmit Data (output)	GND	Signal Ground
7	ERI	No Connection	N/C	No Connection	N/C	No Connection	EAS TxD	
8	N/C	No Connection	N/C	No Connection	+5V out (500mA max)	+5V out	EAS RxD (SHIFT UP)	
9	GN D	Signal Ground	GND	Signal Ground	GND	Signal Ground	NO PIN (BLANK)	
10	N/C	No Connection	N/C	VBUS	N/C	No Connection	NO PIN (BLANK)	

Peripheral Ports / Connectors

PIN	REMOTE DISPLAY		POWER CABLE
	Hardware: 4 pin SDL		Hardware: 3 pin DIN
1	+12 OUT	+12 OUT	SIGNAL GND
2	LINE_A DSPLY	Line A Display	12V IN
3	LINE_A DSPLY	Line B Display	EARTH
4	GND	Ground	

NOTES

Appendix C

Keypad

Use the bar codes in this section to enter numbers and characters as you would select digits/characters from a keypad. Scan your selection from the bar codes below. You'll need to cover any unused bar codes on this and the facing page to ensure that the scanner reads only the bar code you intend to scan.

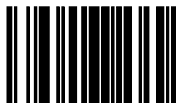

1

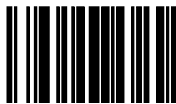

3

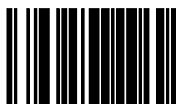

5



0

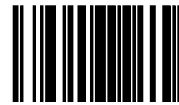

2

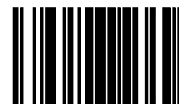

4



6

Use the bar codes in this section to enter numbers and characters as you would select digits/characters from a keypad. Scan your selection from the bar codes below. You'll need to cover any unused bar codes on this and the facing page to ensure that the scanner reads only the bar code you intend to scan.

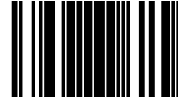

7

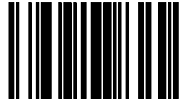

8

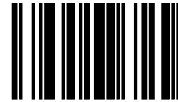

9

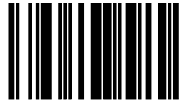

A

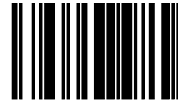

B



C

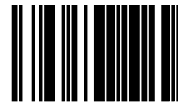

D



E



F

Appendix D

microSD Card

microSDHC Compatibility

At the time of this writing, the microSD card interface for this product supports SD-Memory Card Specifications/ Part 1. Physical Layer Specification; Version 1.01, but the processor MCI can communicate with SDHC Cards. For example, the scanner can perform the functions specified in this appendix for the SDA 2.0 specification. Both FAT16 and FAT32 formats are supported.

Filenames are limited to the 8.3 file naming format (i.e., FILENAME.EXT), and MUST be capitalized.

microSD Card Insertion

1. Read all of these instructions before starting.
2. Apply power to the scanner.
3. Lift the rubber cover to access the card slot as shown in Figure 60.

Figure 60. SD Card Location

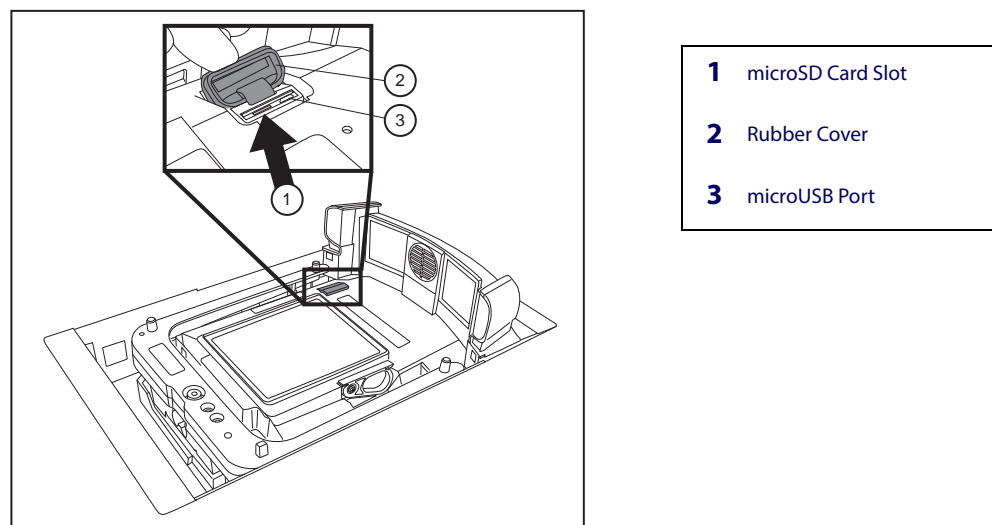

- Carefully insert the microSD card into the slot until it "clicks" into place.



The microSD card slot is spring-loaded. Keep your finger lightly in place atop the card until you are sure it is fully seated in place. See Figure 61

CAUTION Use your finger or thumbnail to push in on the top edge of the card to be slightly below flush with the scanner enclosure when inserting or removing the card. This will engage/disengage the spring mechanism.

Never insert tools or other foreign objects into the microSD card slot.

Figure 61. Inserting the microSD Card

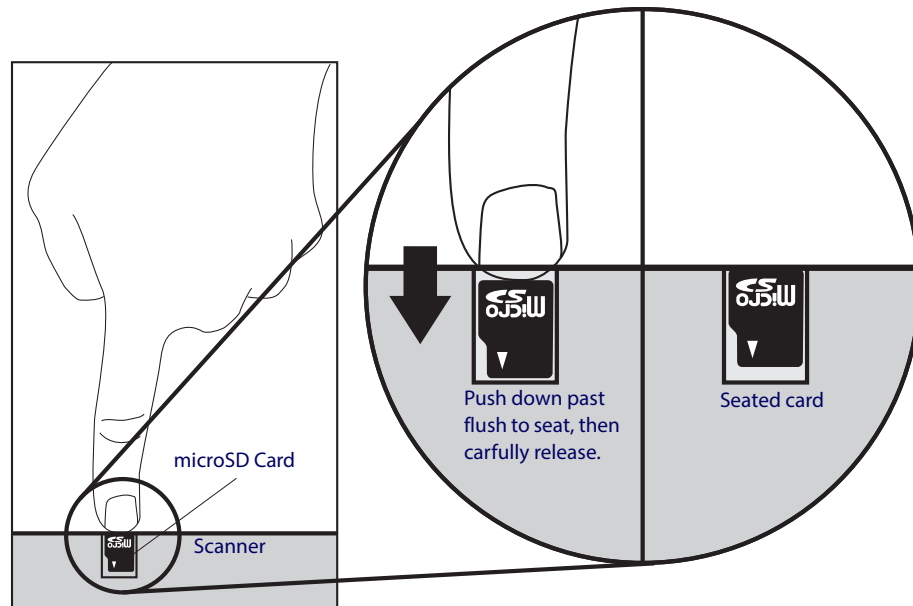

- If installed properly, you should immediately hear an audible signal upon insertion or removal of a microSD card. Various operations will also be indicated by the scanner's good read LED.

microSD Card Removal

Push in gently using your finger or thumbnail to disengage and remove the microSD card. Remember to keep your finger in place atop the card's edge to avoid accidentally "launching" the card from the spring-loaded slot.

Autorun File Processing

After insertion of the card, the scanner will mount the microSD card and search for the file “AUTORUN.DLS”. Embedded in that file is a validation pattern of the ASCII strings “\$START\$” and “\$END\$” located at the respective starting and ending of the file.

If the validation pattern is found, the file may contain any of the following commands. The scanner will parse the file taking action according to these commands. Filenames in italics specify a user-defined name.

Example AUTORUN.DLS file:

```
$START$ (required)
CONFIG, FILENAME.TEX
DUMPSTATS, FILENAME.TXT
DUMPCFG, FILENAME.TEX
LOADSW, FILENAME.BIN
$END$ (required)
```

microSD Function Summary

The following table summarizes various functions of microSD card.

FUNCTION		Image Capture	Export Status	Export Configuration	Load Applic	Load Config	Load CPLD Code	Feature Upgrade*
Direction	Scanner ⇒ microSD Card	√	√	√				
	microSD Card ⇒ Scanner				√	√	√	√
Initiated by	Scanning a label	√	√					
	AUTORUN.DLS file in microSD card		√	√	√	√	√	√

* Contact tech support for any available feature upgrade license.

microSD Function Details

From Scanner to microSD Card

Capture and save an image to a microSD card by scanning a label.

1. Insert the microSD card into the scanner

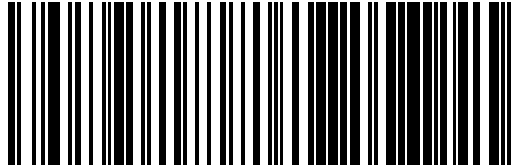

2. Scan the Capture Label

The scanner enters image capture mode.

3. Present the item to be captured to the scanner.

Press and release the Camera Button. The scanner will automatically capture and save the image to the microSD card.

4. Upon scanner audio indication of completion, an image is saved to the microSD card.



NOTE

The image file name range is from IMAGE000 to IMAGE999. If the same name already exists in the microSD card, the scanner skips that name and uses the next. For example, if IMAGE000.JPG is already used in the microSD card, the scanner uses IMAGE001.JPG. The time stamp is not real, since scanner does not have a real time clock.

Image format (.BMP, JPG), image size (VGA, WVGA, Full size), Brightness (0~9), contrast (0~9), and JPG compression ratio (0~100) are defined in configuration.

Export a Configuration file from the Scanner to the microSD card

By AUTORUN.DLS file

1. Generate a text file by any text editor as follows and save it as AUTORUN.DLS.

```
$START$
```

```
DUMPCFG,SDCONFIG.TEX (Filename can be anything, for example "SOME-THING.TEX")
```

```
$END$
```

2. Save or copy file AUTORUN.DLS to microSD card

3. Insert the microSD card to scanner

4. Wait for 3 seconds,

A scanner configuration file named SDCONFIG.TXT is saved to the microSD card.

Export Scanner Status to microSD card

The data includes scanner ID, statistics and scanner health.

By scanning a label

1. Insert the microSD card into the scanner
2. Scan the status export label

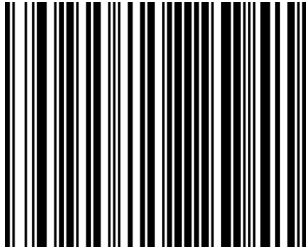

<FNC3>STATUS<CR>

3. Upon scanner audio indication of completion, the scanner status text file named STATUS.TXT is saved to the microSD card.

By AUTORUN.DLS file

1. Generate a text file by any text editor as follows and save it as AUTORUN.DLS
\$START\$
DUMPSTATS,DMPSTATS.TXT
\$END\$
2. Save or copy the AUTORUN.DLS file to the microSD card
3. Insert the microSD card into the scanner
4. Wait for about 3 seconds.

A scanner statistics file named DMPSTATS.TXT is saved to the microSD card.

From microSD Card to Scanner

Application code load to scanner

By AUTORUN.DLS file

1. Generate a text file by any text editor as follows and save it as AUTORUN.DLS
\$START\$
LOADSW,R96-APP1.BIN
\$END\$
2. Step 2: Save or copy file AUTORUN.DLS to microSD card and copy the application code (example R96-APP1.BIN) to the microSD card.
3. Insert the microSD card into the scanner.
4. Upon scanner audio indication of completion, the application code R96-APP1.BIN is loaded to the scanner. Typically, this takes about 45 seconds.

Configuration load to scanner

By Autorun file

1. Generate a text file by any text editor as follows and save it as AUTORUN.DLS
\$START\$
CONFIG,R96-CFG1.TEX
\$END\$
2. Save or copy the autorun.dls file, and copy the CPLD code (example R96-CFG1.TEX) to the microSD card
3. Insert the microSD card into to the scanner
4. Upon scanner audio indication of completion, configuration R96-CFG1.TEX is loaded to the scanner.

Appendix E

Host Commands

Accepting Commands from an RS-232 Scanner Host

The scanner responds to the following RS-232 commands:

COMMAND	ASCII	HEX	COMMENT
Enable Scanner	E	0x45	
Disable Scanner	D	0x44	
Reset Scanner	R	0x52	
Not On File Indication	F	0x46	Long series of beeps
Beep Good Read Tone	B	0x42	Beeps if Good Read Beep is enabled
Force Good Read Tone		0x01	Beeps regardless of beep setting
Bel		0x07	Force Good Read Tone
Identification request	i	0x69	Returns long response ^a
Health request	h	0x68	Returns long response ^a
Status request	s	0x73	Returns long response ^a

a. Call Tech Support for information.

If one of the above commands is received, the scanner will perform the steps indicated for the command. Host commands for other interfaces is also available. Contact Tech Support for more details.

NOTES

Appendix F

Factory Defaults

The following table provides a listing of the most common factory settings for the interfaces shown.



NOTE

Some of the individual interfaces listed in the defaults table below appear in the same column since they share similar feature settings with few (if any) exceptions. Keep in mind though, that the actual configuration storage area for each interface is unique and that updates & changes to factory defaults can be made at any time without notice.

Table 22. Factory Default Settings

Feature	Default Master	RS-232	RS-232 Wincor-Nixdorf	RS-232 Single Cable	Keyboard	USB COM / USB TEC	USB OEM	IBM Port 17 Port 9B Port 5B
Imaging Features								
Mobile Commerce Reader Enable	01 (enable)	01 (enable)	01 (enable)	01 (enable)	01 (enable)	01 (enable)	01 (enable)	01 (enable)
Mobile Commerce Imagers	00 (Mobile Commerce ONLY)	00 (Mobile Commerce ONLY)	00 (Mobile Commerce ONLY)	00 (Mobile Commerce ONLY)	00 (Mobile Commerce ONLY)	00 (Mobile Commerce ONLY)	00 (Mobile Commerce ONLY)	00 (Mobile Commerce ONLY)
Mobile Commerce Button Function	00 (Toggle)	00 (Toggle)	00 (Toggle)	00 (Toggle)	00 (Toggle)	00 (Toggle)	00 (Toggle)	00 (Toggle)
TDR Enable	01 (enable)	01 (enable)	01 (enable)	01 (enable)	01 (enable)	01 (enable)	01 (enable)	01 (enable)
Image Camera	02 (TDR)	02 (TDR)	02 (TDR)	02 (TDR)	02 (TDR)	02 (TDR)	02 (TDR)	02 (TDR)
Image Format	00 (JPG)	00 (JPG)	00 (JPG)	00 (JPG)	00 (JPG)	00 (JPG)	00 (JPG)	00 (JPG)
Image Size	00 (VGA)	00 (VGA)	00 (VGA)	00 (VGA)	00 (VGA)	00 (VGA)	00 (VGA)	00 (VGA)
Image Brightness	Level 0	Level 0	Level 0	Level 0	Level 0	Level 0	Level 0	Level 0
Image Contrast	Level 0	Level 0	Level 0	Level 0	Level 0	Level 0	Level 0	Level 0
General Scanner and Scale Features								
1D Double Read Timeout	28 (400ms)	28 (400ms)	28 (400ms)	28 (400ms)	28 (400ms)	28 (400ms)	28 (400ms)	28 (400ms)
2D Double Read Timeout	46 (700ms)	46 (700ms)	46 (700ms)	46 (700ms)	46 (700ms)	46 (700ms)	46 (700ms)	46 (700ms)

Feature	Default Master	RS-232	RS-232 Wincor-Nixdorf	RS-232 Single Cable	Keyboard	USB COM / USB TEC	USB OEM	IBM Port 17 Port 9B Port 5B
Label Gone Time-out	10 (16 cycles)	10 (16 cycles)	10 (16 cycles)	10 (16 cycles)	10 (16 cycles)	10 (16 cycles)	10 (16 cycles)	10 (16 cycles)
Sleep Mode Timer	5 minutes	5 minutes	5 minutes	5 minutes	5 minutes	5 minutes	5 minutes	5 minutes
1D Inverse Read Control	00 (disable)	00 (disable)	00 (disable)	00 (disable)	00 (disable)	00 (disable)	00 (disable)	00 (disable)
2D Inverse Read Control	00 (disable)	00 (disable)	00 (disable)	00 (disable)	00 (disable)	00 (disable)	00 (disable)	00 (disable)
Illumination Control	00 (disable)	00 (disable)	00 (disable)	00 (disable)	00 (disable)	00 (disable)	00 (disable)	00 (disable)
2D Contrast Improvement	00 (disable)	00 (disable)	00 (disable)	00 (disable)	00 (disable)	00 (disable)	00 (disable)	00 (disable)
Good Read LED Idle State	02 (on dim)	02 (on dim)	02 (on dim)	02 (on dim)	02 (on dim)	02 (on dim)	02 (on dim)	02 (on dim)
Scanner Control Button Options	00 (enable all)	00 (enable all)	00 (enable all)	00 (enable all)	00 (enable all)	00 (enable all)	00 (enable all)	00 (enable all)
Power-up Tone Control	01 (1 beep)	01 (1 beep)	01 (1 beep)	01 (1 beep)	01 (1 beep)	01 (1 beep)	01 (1 beep)	01 (1 beep)
Good Read Beep Control	01 (enable)	01 (enable)	01 (enable)	01 (enable)	01 (enable)	01 (enable)	01 (enable)	01 (enable)
Good Read Beep Frequency	01 (med.)	01 (med.)	01 (med.)	01 (med.)	01 (med.)	01 (med.)	01 (med.)	01 (med.)
Good Read Beep Length	008 (80ms)	008 (80ms)	008 (80ms)	008 (80ms)	008 (80ms)	008 (80ms)	008 (80ms)	008 (80ms)
Good Read Beep Volume	04 (high)	04 (high)	04 (high)	04 (high)	04 (high)	04 (high)	04 (high)	04 (high)
Good Read When to Indicate	00 (after decode)	00 (after decode)	00 (after decode)	00 (after decode)	00 (after decode)	00 (after decode)	00 (after decode)	00 (after decode)
Scale Zero Button and Scale Indicator LED	03 (zero button & LED disconnected)	03 (zero button & LED disconnected)	03 (zero button & LED disconnected)	03 (zero button & LED disconnected)		03 (zero button & LED disconnected)	03 (zero button & LED disconnected)	03 (zero button & LED disconnected)
Scale Sentry	01 (enable)	01 (enable)	01 (enable)	01 (enable)		01 (enable)	01 (enable)	01 (enable)
Scale Sentry Block Weight Transmission	01 (enable)	01 (enable)	01 (enable)	01 (enable)	01 (enable)	01 (enable)	01 (enable)	01 (enable)
Scale Sentry Override Button	01 (enable)	01 (enable)	01 (enable)	01 (enable)	01 (enable)	01 (enable)	01 (enable)	01 (enable)
Scale Enable	01 (enable)	01 (enable)	01 (enable)	01 (enable)		01 (enable)	01 (enable)	01 (enable)
Scale Diagnostics Mode	01 (enable)	01 (enable)	01 (enable)	01 (enable)		01 (enable)	01 (enable)	01 (enable)
Scale Stale Weight Timeout	330ms			330ms				

Feature	Default Master	RS-232	RS-232 Wincor-Nixdorf	RS-232 Single Cable	Keyboard	USB COM / USB TEC	USB OEM	IBM Port 17 Port 9B Port 5B
Scale Enforced Zero Return	03 (non-zero for 4 min.)	03 (non-zero for 4 min.)	03 (non-zero for 4 min.)	00 (disable)		03 (non-zero for 4 min.)	03 (non-zero for 4 min.)	03 (non-zero for 4 min.)
Scale Interface Type	04 (RS-232 SASI)	04 (RS-232 SASI)	04 (RS-232 SASI)			04 (RS-232 SASI)	04 (RS-232 SASI)	
Scale Calibration Notification	00 (disable)	00 (disable)	00 (disable)	00 (disable)		00 (disable)	00 (disable)	00 (disable)
Scale Intercharacter Delay	00 (no delay)	00 (no delay)	00 (no delay)			00 (no delay)		
Remote Display — Enable/Disable	01 (enable)	01 (enable)	01 (enable)	01 (enable)		01 (enable)	01 (enable)	01 (enable)
Auxiliary Port Mode	00 (disable)	00 (disable)	01 (external HH input)	00 (disable)	00 (disable)	00 (disable)	00 (disable)	00 (disable)
Auxiliary USB Mode	00 (disable)	00 (disable)	00 (disable)	00 (disable)	00 (disable)	00 (disable)	00 (disable)	00 (disable)
Productivity Index Reporting (PIR) / Cashier Training (CT)	00 (disable)	00 (disable)	00 (disable)	00 (disable)	00 (disable)	00 (disable)	00 (disable)	00 (disable)
PIR/CT Auxiliary Port Baud Rate	00 (19200)	00 (19200)	00 (19200)	00 (19200)	00 (19200)	00 (19200)	00 (19200)	00 (19200)
EAS Features								
EAS Mode	00 (disable)	00 (disable)	00 (disable)	00 (disable)	00 (disable)	00 (disable)	00 (disable)	00 (disable)
EAS Notification	00 (disable)	00 (disable)	00 (disable)	00 (disable)	00 (disable)	00 (disable)	00 (disable)	00 (disable)
EAS Security Level	01 (med.)	01 (med.)	01 (med.)	01 (med.)	01 (med.)	01 (med.)	01 (med.)	01 (med.)
EAS Good Beep Mode	00 (disable)	00 (disable)	00 (disable)	00 (disable)	00 (disable)	00 (disable)	00 (disable)	00 (disable)
EAS Beep Duration	008 (80ms)	008 (80ms)	008 (80ms)	008 (80ms)	008 (80ms)	008 (80ms)	008 (80ms)	008 (80ms)
EAS Retry Count	03 (retry 3 times)	03 (retry 3 times)	03 (retry 3 times)	03 (retry 3 times)	03 (retry 3 times)	03 (retry 3 times)	03 (retry 3 times)	03 (retry 3 times)
EAS Exception Button	02 (enable only when scanner enabled)	02 (enable only when scanner enabled)	02 (enable only when scanner enabled)	02 (enable only when scanner enabled)	02 (enable only when scanner enabled)	02 (enable only when scanner enabled)	02 (enable only when scanner enabled)	02 (enable only when scanner enabled)
EAS Deactivation Duration — Coupled	040 (400ms)	040 (400ms)	040 (400ms)	040 (400ms)	040 (400ms)	040 (400ms)	040 (400ms)	040 (400ms)
EAS Deactivation Duration — Retry	050 (500ms)	050 (500ms)	050 (500ms)	050 (500ms)	050 (500ms)	050 (500ms)	050 (500ms)	050 (500ms)
EAS Deactivation Duration — Exception	100 (1 sec.)	100 (1 sec.)	100 (1 sec.)	100 (1 sec.)	100 (1 sec.)	100 (1 sec.)	100 (1 sec.)	100 (1 sec.)

Feature	Default Master	RS-232	RS-232 Wincor-Nixdorf	RS-232 Single Cable	Keyboard	USB COM / USB TEC	USB OEM	IBM Port 17 Port 9B Port 5B
EAS Pre-Read Time	025 (250ms)	025 (250ms)	025 (250ms)	025 (250ms)	025 (250ms)	025 (250ms)	025 (250ms)	025 (250ms)
ERI Active State	00 (low)	00 (low)	00 (low)	00 (low)	00 (low)	00 (low)	00 (low)	00 (low)
ERI Timeout	02 (20ms)	02 (20ms)	02 (20ms)	02 (20ms)	02 (20ms)	02 (20ms)	02 (20ms)	02 (20ms)

Interface Related Features								
Maximum Host-Transmitted Message Length	000 (no gen. limit imposed)	000 (no gen. limit imposed)	000 (no gen. limit imposed)	000 (no gen. limit imposed)	000 (no gen. limit imposed)	000 (no gen. limit imposed)	000 (no gen. limit imposed)	000 (no gen. limit imposed)
IBM Interface Options	00	00	00	10	00	00	00	00
IBM Scale Address	6E						6E	6E
IBM Transmit Labels in Code 39 Format	00 (disable)						00 (disable)	00 (disable)
46XX Number of Host Resets	06						06	06
46XX Label Slicing Control	01 (multi pieces)						01 (multi pieces)	01 (multi pieces)
46XX Maximum Label Slice Length	064 (64 characters)						064 (64 characters)	064 (64 characters)
USB OEM Interface Options	02	02	02	02	02	02	01	02
USB OEM Scanner Device Type	00 (table top)						00 (table top)	00 (table top)
RS-232 Baud Rate	01 (9600)	01 (9600)	01 (9600)	01 (9600)		01 (9600)		
RS-232 Number of Data Bits	01 (8 data bits)	01 (8 data bits)	01 (8 data bits)	00 (7 data bits)		01 (8 data bits)		
RS-232 Number of Stop Bits	00 (1 stop bit)	00 (1 stop bit)	00 (1 stop bit)	00 (1 stop bit)		00 (1 stop bit)		
RS-232 Parity	00 (none)	00 (none)	02 (odd)	02 (odd)		00 (none)		
RS-232 Hardware Control	00 (disable)	00 (disable)	01 (enable CTS flow control)			00 (disable)		
RS-232 Intercharacter Delay	00 (no delay)	00 (no delay)	00 (no delay)			00 (no delay)		
RS-232 Software Flow Control	00 (disable)	00 (disable)	00 (disable)	00 (disable)		00 (disable)		
RS-232 Ignore Host Commands	01 (ignore)	01 (ignore)	01 (ignore)	01 (ignore)	01 (ignore)	01 (ignore)	01 (ignore)	01 (ignore)

Feature	Default Master	RS-232	RS-232 Wincor-Nixdorf	RS-232 Single Cable	Keyboard	USB COM / USB TEC	USB OEM	IBM Port 17 Port 9B Port 5B
RS-232 TTL	00 (normal)	00 (normal)	00 (normal)			00 (normal)		
RS-232 TTL Invert	00 (disable)	00 (disable)	00 (disable)			00 (disable)		
RS-232 Beep on ASCII BEL	00 (disable)	00 (disable)	00 (disable)			00 (disable)		
RS-232 Beep After Weigh	00 (disable)	00 (disable)	00 (disable)	00 (disable)		00 (disable)		
Beep on Not on File	01 (low vol)	01 (low vol)	01 (low vol)	01 (low vol)		01 (low vol)	01 (low vol)	01 (low vol)
RS-232 ACK NAK Enable	00 (disable)	00 (disable)	00 (disable)			00 (disable)		
RS-232 ACK Character	06 (ACK)	06 (ACK)	06 (ACK)			06 (ACK)		
RS-232 NAK Character	15 (NAK)	15 (NAK)	15 (NAK)			15 (NAK)		
RS-232 Retry on ACK NAK Timeout	01 (enable)	01 (enable)	01 (enable)			01 (enable)		
RS-232 ACK NAK Timeout Value	01 (200ms)	01 (200ms)	01 (200ms)			01 (200ms)		
RS-232 ACK NAK Retry Count	03 (3 retries)	03 (3 retries)	03 (3 retries)			03 (3 retries)		
RS-232 ACK NAK Error Handling	00 (ignore)	00 (ignore)	00 (ignore)			00 (ignore)		
RS-232 Indicate Transmission Failure	01 (enable)	01 (enable)	01 (enable)			01 (enable)		
Single Cable RS-232 Scanner Only Protocol	00 (scanner/scale RS-232)			00 (scanner/scale RS-232)				
Single Cable RS-232 RTS CTS Selection	05 (RTS high, wait for CTS)			05 (RTS high, wait for CTS)				
Single Cable RS-232 Use BCC	00 (disable)			00 (disable)				
Single Cable RS-232 Use ACK/NAK	00 (disable)			00 (disable)				
Single Cable RS-232 Use STX	01 (enable)			01 (enable)				
Set Single Cable RS-232 STX Character	053 (S)			053 (S)				
Single Cable RS-232 Use ETX	01 (enable)			01 (enable)				
Set Single Cable RS-232 ETX Character	00D (CR)			00D (CR)				

Feature	Default Master	RS-232	RS-232 Wincor-Nixdorf	RS-232 Single Cable	Keyboard	USB COM / USB TEC	USB OEM	IBM Port 17 Port 9B Port 5B
Single Cable RS-232 Datalogic Extensions	00 (std. protocol)			00 (std. protocol)				
Single Cable RS-232 Pacesetter Plus	00 (do not send)			00 (do not send)				
USB Keyboard and Keyboard Wedge Intercharacter Delay	01 (10ms)				01 (10ms)			
Keyboard Wedge No Keyboard Support	00 (disable)				00 (disable)			
USB Keyboard and Keyboard Wedge Send Control Characters	00 (disable)				00 (disable)			
USB Keyboard and Keyboard Wedge Country Mode	00 (USA)				00 (USA)			
Keyboard Wedge Quiet Interval	0A (100ms)				0A (100ms)			
USB Keyboard and Keyboard Wedge Caps Lock State	00 (caps lock OFF)				00 (caps lock OFF)			
Data Editing								
Case Conversion	00 (no case convers'n)	00 (no case convers'n)	00 (no case convers'n)	00 (no case convers'n)	00 (no case convers'n)	00 (no case convers'n)	00 (no case convers'n)	00 (no case convers'n)
Character Conversion	FFFFFFFF FFFFFFF (no char. convers'n)	FFFFFFFF FFFFFFF (no char. convers'n)	FFFFFFFF FFFFFFF (no char. convers'n)	FFFFFFFF FFFFFFF (no char. convers'n)	FFFFFFFF FFFFFFF (no char. convers'n)	FFFFFFFF FFFFFFF (no char. convers'n)	FFFFFFFF FFFFFFF (no char. convers'n)	FFFFFFFF FFFFFFF (no char. convers'n)
Global Prefix	00 (no prefix)	00 (no prefix)	00 (no prefix)	00 (no prefix)	00 (no prefix)	00 (no prefix)	00 (no prefix)	00 (no prefix)
Global Suffix	0D00 (CR)	0D00 (CR)	0D00 (CR)	0000 (CR)	0D00 (CR)	0D00 (CR)	0D00 (CR)	0D00 (CR)
Global AIM ID Enable	00 (disable)	00 (disable)	00 (disable)	00 (disable)	00 (disable)	00 (disable)		
Label ID Control	01 (Enable as prefix)	01 (Enable as prefix)	01 (Enable as prefix)	01 (Enable as prefix)	01 (Enable as prefix)	01 (Enable as prefix)		
Global Mid-Label ID	00 (no mid-label ID)	00 (no mid-label ID)	00 (no mid-label ID)	00 (no mid-label ID)	00 (no mid-label ID)	00 (no mid-label ID)		
1D Symbology Programming								
Coupon Control	01 (enable UPC-A)	01 (enable UPC-A)	01 (enable UPC-A)	01 (enable UPC-A)	01 (enable UPC-A)	01 (enable UPC-A)	01 (enable UPC-A)	01 (enable UPC-A)

Feature	Default Master	RS-232	RS-232 Wincor-Nixdorf	RS-232 Single Cable	Keyboard	USB COM / USB TEC	USB OEM	IBM Port 17 Port 9B Port 5B
UPC-A Enable	01 (enable)	01 (enable)	01 (enable)	01 (enable)	01 (enable)	01 (enable)	01 (enable)	01 (enable)
UPC-A Number System Character Transmission	01 (enable)	01 (enable)	01 (enable)	01 (enable)	01 (enable)	01 (enable)	01 (enable)	01 (enable)
UPC-A Check Character Transmission	01 (enable)	01 (enable)	01 (enable)	00 (disable)	01 (enable)	01 (enable)	01 (enable)	01 (enable)
UPC-A Minimum Read	01 (1 read)	01 (1 read)	01 (1 read)	01 (1 read)	01 (1 read)	01 (1 read)	01 (1 read)	01 (1 read)
Expand UPC-A to EAN-13	00 (disable)	00 (disable)	01 (enable)	00 (disable)	00 (disable)	00 (disable)	00 (disable)	00 (disable)
UPC-E Enable	01 (enable)	01 (enable)	01 (enable)	01 (enable)	01 (enable)	01 (enable)	01 (enable)	01 (enable)
UPC-E Number System Character Transmission	01 (enable)	01 (enable)	01 (enable)	01 (enable)	01 (enable)	01 (enable)	01 (enable)	01 (enable)
UPC-E Check Character Transmission	01 (enable)	01 (enable)	00 (disable)	01 (enable)	01 (enable)	01 (enable)	01 (enable)	01 (enable)
Expand UPC-E to UPC-A	00 (disable)	00 (disable)	00 (disable)	00 (disable)	00 (disable)	00 (disable)	00 (disable)	00 (disable)
Expand UPC-E to EAN-13	00 (disable)	00 (disable)	00 (disable)	00 (disable)	00 (disable)	00 (disable)	00 (disable)	00 (disable)
UPC-E Minimum Read	01 (1 read)	01 (1 read)	01 (1 read)	01 (1 read)	01 (1 read)	01 (1 read)	01 (1 read)	01 (1 read)
EAN-13 Enable	01 (enable)	01 (enable)	01 (enable)	01 (enable)	01 (enable)	01 (enable)	01 (enable)	01 (enable)
EAN-13 First Character Transmission	01 (enable)	01 (enable)	01 (enable)	01 (enable)	01 (enable)	01 (enable)	01 (enable)	01 (enable)
EAN-13 Check Character Transmission	01 (enable)	01 (enable)	01 (enable)	00 (disable)	01 (enable)	01 (enable)	01 (enable)	01 (enable)
EAN-13 ISBN Conversion Enable	00 (disable)	00 (disable)	00 (disable)	00 (disable)	00 (disable)	00 (disable)	00 (disable)	00 (disable)
EAN-13 Minimum Read	01 (1 read)	01 (1 read)	01 (1 read)	01 (1 read)	01 (1 read)	01 (1 read)	01 (1 read)	01 (1 read)
EAN-8 Enable	01 (enable)	01 (enable)	01 (enable)	01 (enable)	01 (enable)	01 (enable)	01 (enable)	01 (enable)
EAN-8 Check Character Transmission	01 (enable)	01 (enable)	01 (enable)	00 (disable)	01 (enable)	01 (enable)	01 (enable)	01 (enable)
Expand EAN-8 to EAN-13	00 (disable)	00 (disable)	00 (disable)	00 (disable)	00 (disable)	00 (disable)	00 (disable)	00 (disable)
EAN-8 Minimum Read	01 (1 read)	01 (1 read)	01 (1 read)	01 (1 read)	01 (1 read)	01 (1 read)	01 (1 read)	01 (1 read)
EAN-8 Guard Insertion	00 (disable)	00 (disable)	00 (disable)	00 (disable)	00 (disable)	00 (disable)	00 (disable)	00 (disable)

Feature	Default Master	RS-232	RS-232 Wincor-Nixdorf	RS-232 Single Cable	Keyboard	USB COM / USB TEC	USB OEM	IBM Port 17 Port 9B Port 5B
EAN-8 Guard Substitution	00 (disable)	00 (disable)	00 (disable)	00 (disable)	00 (disable)	00 (disable)	00 (disable)	00 (disable)
EAN-8 Stitch Exact Label Halves	00 (disable)	00 (disable)	00 (disable)	00 (disable)	00 (disable)	00 (disable)	00 (disable)	00 (disable)
EAN-8 Stitch Unlike Label Halves	00 (disable)	00 (disable)	00 (disable)	00 (disable)	00 (disable)	00 (disable)	00 (disable)	00 (disable)
In-Store Printed Label Minimum Read	01 (1 read)	01 (1 read)	01 (1 read)	01 (1 read)	01 (1 read)	01 (1 read)	01 (1 read)	01 (1 read)
UPC/EAN Reconstruction	00 (disable)	00 (disable)	00 (disable)	00 (disable)	00 (disable)	00 (disable)		
UPC/EAN Correlation	00 (disable)	00 (disable)	00 (disable)	00 (disable)	00 (disable)	00 (disable)	00 (disable)	00 (disable)
UPC/EAN Guard Insertion	00 (disable)	00 (disable)	00 (disable)	00 (disable)	00 (disable)	00 (disable)	00 (disable)	00 (disable)
UPC/EAN Stitch Exact Label Halves	00 (disable)	00 (disable)	00 (disable)	00 (disable)	00 (disable)	00 (disable)	00 (disable)	00 (disable)
UPC/EAN Stitch Unlike Label Halves	00 (disable)	00 (disable)	00 (disable)	00 (disable)	00 (disable)	00 (disable)	00 (disable)	00 (disable)
UPC/EAN Minimum Segment Length	05 (5 char.)	05 (5 char.)	05 (5 char.)	05 (5 char.)	05 (5 char.)	05 (5 char.)	05 (5 char.)	05 (5 char.)
Price Weight Check	00 (disable)	00 (disable)	00 (disable)	00 (disable)	00 (disable)	00 (disable)	00 (disable)	00 (disable)
Enable EAN Two Label	00 (disable)	00 (disable)	00 (disable)	00 (disable)	00 (disable)	00 (disable)	00 (disable)	00 (disable)
EAN Two Label Minimum Read	01 (1 read)	01 (1 read)	01 (1 read)	01 (1 read)	01 (1 read)	01 (1 read)	01 (1 read)	01 (1 read)
Addons	disable all	disable all	disable all	disable all	disable all	disable all	disable all	disable all
P2 Addon Minimum Read	02 (2 reads)	02 (2 reads)	02 (2 reads)	02 (2 reads)	02 (2 reads)	02 (2 reads)	02 (2 reads)	02 (2 reads)
P5 Addon Minimum Read	01 (1 read)	01 (1 read)	01 (1 read)	01 (1 read)	01 (1 read)	01 (1 read)	01 (1 read)	01 (1 read)
GTIN Enable	00 (disable)	00 (disable)	00 (disable)	00 (disable)	00 (disable)	00 (disable)		
DataBar Omnidirectional Enable	00 (disable)	00 (disable)	00 (disable)	00 (disable)	00 (disable)	00 (disable)	00 (disable)	00 (disable)
DataBar Omnidirectional/EAN-128 Emulation	00 (disable)	00 (disable)	00 (disable)	00 (disable)	00 (disable)	00 (disable)	00 (disable)	00 (disable)
DataBar Omnidirectional 2D Component Enable	00 (disable)	00 (disable)	00 (disable)	00 (disable)	00 (disable)	00 (disable)	00 (disable)	00 (disable)

Feature	Default Master	RS-232	RS-232 Wincor-Nixdorf	RS-232 Single Cable	Keyboard	USB COM / USB TEC	USB OEM	IBM Port 17 Port 9B Port 5B
DataBar Omnidirectional Minimum Read	01 (1 read)	01 (1 read)	01 (1 read)	01 (1 read)	01 (1 read)	01 (1 read)	01 (1 read)	01 (1 read)
DataBar Expanded Enable	00 (disable)	00 (disable)	00 (disable)	00 (disable)	00 (disable)	00 (disable)	00 (disable)	00 (disable)
DataBar Expanded EAN-128 Emulation	00 (disable)	00 (disable)	00 (disable)	00 (disable)	00 (disable)	00 (disable)	00 (disable)	00 (disable)
DataBar Expanded 2D Component Enable	00 (disable)	00 (disable)	00 (disable)	00 (disable)	00 (disable)	00 (disable)	00 (disable)	00 (disable)
DataBar Expanded Minimum Read	01 (1 read)	01 (1 read)	01 (1 read)	01 (1 read)	01 (1 read)	01 (1 read)	01 (1 read)	01 (1 read)
DataBar Expanded Length Control	00 (variable)	00 (variable)	00 (variable)	00 (variable)	00 (variable)	00 (variable)	00 (variable)	00 (variable)
DataBar Expanded Length 1	01	01	01	01	01	01	01	01
DataBar Expanded Length 2	74	74	74	74	74	74	74	74
Code 39 Enable	01 (enable)	01 (enable)	00 (disable)	01 (enable)	01 (enable)	01 (enable)	01 (enable)	01 (enable)
Code 39 Start Stop Character Transmission	00 (disable)	00 (disable)	00 (disable)	00 (disable)	00 (disable)	00 (disable)	00 (disable)	00 (disable)
Code 39 Check Character Calculation	00 (disable)	00 (disable)	00 (disable)	00 (disable)	00 (disable)	00 (disable)	00 (disable)	00 (disable)
Code 39 Check Character Transmission	01 (enable)	01 (enable)	01 (enable)	01 (enable)	01 (enable)	01 (enable)	01 (enable)	01 (enable)
Code 39 Full ASCII	00 (disable)	00 (disable)	00 (disable)	00 (disable)	00 (disable)	00 (disable)	00 (disable)	00 (disable)
Code 39 Minimum Read	01 (1 read)	01 (1 read)	01 (1 read)	01 (1 read)	01 (1 read)	01 (1 read)	01 (1 read)	01 (1 read)
Code 39 Correlation	00 (disable)	00 (disable)	00 (disable)	00 (disable)	00 (disable)	00 (disable)	00 (disable)	00 (disable)
Code 39 Length Control	00 (variable)	00 (variable)	00 (variable)	00 (variable)	00 (variable)	00 (variable)	00 (variable)	00 (variable)
Code 39 Length 1	02	02	02	02	02	02	02	02
Code 39 Length 2	50	50	50	50	50	50	50	50
Code 39 Stitching	01 (enable)	01 (enable)	01 (enable)	01 (enable)	01 (enable)	01 (enable)	01 (enable)	01 (enable)
Code 39 Require Margins	00 (disable)	00 (disable)	00 (disable)	00 (disable)	00 (disable)	00 (disable)	00 (disable)	00 (disable)
Code 32 Italian Pharmacode Enable	00 (disable)	00 (disable)	00 (disable)	00 (disable)	00 (disable)	00 (disable)	00 (disable)	00 (disable)

Feature	Default Master	RS-232	RS-232 Wincor-Nixdorf	RS-232 Single Cable	Keyboard	USB COM / USB TEC	USB OEM	IBM Port 17 Port 9B Port 5B
Code 32 Start Stop Character Transmission	00 (disable)	00 (disable)	00 (disable)	00 (disable)	00 (disable)	00 (disable)	00 (disable)	00 (disable)
Code 32 Check Character Transmission	00 (disable)	00 (disable)	00 (disable)	00 (disable)	00 (disable)	00 (disable)		00 (disable)
Code 128 Enable	01 (enable)	01 (enable)	01 (enable)	01 (enable)	01 (enable)	01 (enable)	01 (enable)	01 (enable)
Code 128 Transmit Function Characters	00 (disable)	00 (disable)	00 (disable)	00 (disable)	00 (disable)	00 (disable)	00 (disable)	00 (disable)
Expand Code128 to Code 39	00 (disable)	00 (disable)	00 (disable)	00 (disable)	00 (disable)	00 (disable)	00 (disable)	00 (disable)
Code 128 Minimum Read	01 (1 read)	01 (1 read)	01 (1 read)	01 (1 read)	01 (1 read)	01 (1 read)	01 (1 read)	01 (1 read)
Code 128 Correlation	00 (disable)	00 (disable)	00 (disable)	00 (disable)	00 (disable)	00 (disable)	00 (disable)	00 (disable)
Code 128 Length Control	00 (variable)	00 (variable)	00 (variable)	00 (variable)	00 (variable)	00 (variable)	00 (variable)	00 (variable)
Code 128 Length 1	01	01	01	01	01	01	01	01
Code 128 Length 2	80	80	80	80	80	80	80	80
Code 128 Stitching	01 (enable)	01 (enable)	01 (enable)	01 (enable)	01 (enable)	01 (enable)	01 (enable)	01 (enable)
EAN-128 Enable	00 (disable)	00 (disable)	00 (disable)	00 (disable)	00 (disable)	00 (disable)	00 (disable)	00 (disable)
Interleaved 2 of 5 (I 2 OF 5) Enable	00 (disable)	00 (disable)	00 (disable)	00 (disable)	00 (disable)	00 (disable)	00 (disable)	00 (disable)
I 2 of 5 Check Character Calculation	00 (disable)	00 (disable)	00 (disable)	00 (disable)	00 (disable)	00 (disable)	00 (disable)	00 (disable)
I 2 of 5 Check Character Transmission	01 (enable)	01 (enable)	01 (enable)	01 (enable)	01 (enable)	01 (enable)	01 (enable)	01 (enable)
I 2 of 5 Minimum Read	01 (1 read)	01 (1 read)	01 (1 read)	01 (1 read)	01 (1 read)	01 (1 read)	01 (1 read)	01 (1 read)
I 2 of 5 Correlation	00 (disable)	00 (disable)	00 (disable)	00 (disable)	00 (disable)	00 (disable)	00 (disable)	00 (disable)
I 2 of 5 Length Control	00 (variable)	00 (variable)	00 (variable)	00 (variable)	00 (variable)	00 (variable)	00 (variable)	00 (variable)
I 2 of 5 Length 1	06	06	06	06	06	06	06	06
I 2 of 5 Length 2	50	50	50	50	50	50	50	50
I 2 of 5 Stitching	00 (disable)	00 (disable)	00 (disable)	00 (disable)	00 (disable)	00 (disable)	00 (disable)	00 (disable)
Codabar Enable	00 (disable)	00 (disable)	00 (disable)	00 (disable)	00 (disable)	00 (disable)	00 (disable)	00 (disable)
Codabar Start Stop Character Transmission	01 (enable)	01 (enable)	01 (enable)	01 (enable)	01 (enable)	01 (enable)	01 (enable)	01 (enable)

Feature	Default Master	RS-232	RS-232 Wincor-Nixdorf	RS-232 Single Cable	Keyboard	USB COM / USB TEC	USB OEM	IBM Port 17 Port 9B Port 5B
Codabar Start Stop Character Set	03 (abcd/abcd)	03 (abcd/abcd)	03 (abcd/abcd)	03 (abcd/abcd)	03 (abcd/abcd)	03 (abcd/abcd)	03 (abcd/abcd)	03 (abcd/abcd)
Codabar Start Stop Character Match	00 (disable)	00 (disable)	00 (disable)	00 (disable)	00 (disable)	00 (disable)	00 (disable)	00 (disable)
Codabar Check Character Calculation	00 (disable)	00 (disable)	00 (disable)	00 (disable)	00 (disable)	00 (disable)	00 (disable)	00 (disable)
Codabar Check Character Transmission	01 (enable)	01 (enable)	01 (enable)	01 (enable)	01 (enable)	01 (enable)	01 (enable)	01 (enable)
Codabar Minimum Read	01 (1 read)	01 (1 read)	01 (1 read)	01 (1 read)	01 (1 read)	01 (1 read)	01 (1 read)	01 (1 read)
Codabar Correlation	00 (disable)	00 (disable)	00 (disable)	00 (disable)	00 (disable)	00 (disable)	00 (disable)	00 (disable)
Codabar Length Control	00 (variable)	00 (variable)	00 (variable)	00 (variable)	00 (variable)	00 (variable)	00 (variable)	00 (variable)
Codabar Length 1	03	03	03	03	03	03	03	03
Codabar Length 2	50	50	50	50	50	50	50	50
Codabar Stitching	00 (disable)	00 (disable)	00 (disable)	00 (disable)	00 (disable)	00 (disable)	00 (disable)	00 (disable)
Codabar Require Margins	00 (disable)	00 (disable)	00 (disable)	00 (disable)	00 (disable)	00 (disable)	00 (disable)	00 (disable)
Code 93 Enable	00 (disable)	00 (disable)	00 (disable)	00 (disable)	00 (disable)	00 (disable)	00 (disable)	00 (disable)
Code 93 Minimum Read	01 (1 read)	01 (1 read)	01 (1 read)	01 (1 read)	01 (1 read)	01 (1 read)	01 (1 read)	01 (1 read)
Code 93 Correlation	00 (disable)	00 (disable)	00 (disable)	00 (disable)	00 (disable)	00 (disable)	00 (disable)	00 (disable)
Code 93 Length Control	00 (variable)	00 (variable)	00 (variable)	00 (variable)	00 (variable)	00 (variable)	00 (variable)	00 (variable)
Code 93 Length 1	01	01	01	01	01	01	01	01
Code 93 Length 2	50	50	50	50	50	50	50	50
Code 93 Stitching	01 (enable)	01 (enable)	01 (enable)	01 (enable)	01 (enable)	01 (enable)	01 (enable)	01 (enable)
MSI Enable	00 (disable)	00 (disable)	00 (disable)	00 (disable)	00 (disable)	00 (disable)		
MSI Check Character Calculation	01 (enable)	01 (enable)	01 (enable)	01 (enable)	01 (enable)	01 (enable)		
MSI Number of Check Characters	00 (1 char)	00 (1 char)	00 (1 char)	00 (1 char)	00 (1 char)	00 (1 char)		
MSI Check Character Transmission	01 (enable)	01 (enable)	01 (enable)	01 (enable)	01 (enable)	01 (enable)		
MSI Minimum Read	01 (1 read)	01 (1 read)	01 (1 read)	01 (1 read)	01 (1 read)	01 (1 read)		
MSI Correlation	00 (disable)	00 (disable)	00 (disable)	00 (disable)	00 (disable)	00 (disable)		

Feature	Default Master	RS-232	RS-232 Wincor-Nixdorf	RS-232 Single Cable	Keyboard	USB COM / USB TEC	USB OEM	IBM Port 17 Port 9B Port 5B
MSI Length Control	00 (variable)	00 (variable)	00 (variable)	00 (variable)	00 (variable)	00 (variable)		
MSI Length 1	04	04	04	04	04	04		
MSI Length 2	16	16	16	16	16	16		
MSI Stitching	00 (disable)	00 (disable)	00 (disable)	00 (disable)	00 (disable)	00 (disable)		
Standard 2 of 5 Enable	00 (disable)	00 (disable)	00 (disable)	00 (disable)	00 (disable)	00 (disable)	00 (disable)	00 (disable)
Standard 2 of 5 Check Character Calculation	00 (disable)	00 (disable)	00 (disable)	00 (disable)	00 (disable)	00 (disable)	00 (disable)	00 (disable)
Standard 2 of 5 Check Character Transmission	01 (enable)	01 (enable)	01 (enable)	01 (enable)	01 (enable)	01 (enable)	01 (enable)	01 (enable)
Standard 2 of 5 Minimum Read	01 (1 read)	01 (1 read)	01 (1 read)	01 (1 read)	01 (1 read)	01 (1 read)	01 (1 read)	01 (1 read)
Standard 2 of 5 Correlation	00 (disable)	00 (disable)	00 (disable)	00 (disable)	00 (disable)	00 (disable)	00 (disable)	00 (disable)
Standard 2 of 5 Length Control	00 (variable)	00 (variable)	00 (variable)	00 (variable)	00 (variable)	00 (variable)	00 (variable)	00 (variable)
Standard 2 of 5 Length 1	08	08	08	08	08	08	08	08
Standard 2 of 5 Length 2	50	50	50	50	50	50	50	50
Standard 2 of 5 Stitching	00 (disable)	00 (disable)	00 (disable)	00 (disable)	00 (disable)	00 (disable)	00 (disable)	00 (disable)
2D Symbology Programming								
Data Matrix Enable	00 (disable)	00 (disable)	00 (disable)	00 (disable)	00 (disable)	00 (disable)	00 (disable)	00 (disable)
Data Matrix Length Control	00 (variable)	00 (variable)	00 (variable)	00 (variable)	00 (variable)	00 (variable)	00 (variable)	00 (variable)
Set Data Matrix Length 1	0001	0001	0001	0001	0001	0001	0001	0001
Set Data Matrix Length 2	0800	0800	0800	0800	0800	0800	0800	0800
PDF 417 Enable	01 (enable)	01 (enable)	01 (enable)	01 (enable)	01 (enable)	01 (enable)	01 (enable)	01 (enable)
PDF 417 Length Control	00 (variable)	00 (variable)	00 (variable)	00 (variable)	00 (variable)	00 (variable)	00 (variable)	00 (variable)
Set PDF 417 Length 1	0001	0001	0001	0001	0001	0001	0001	0001
Set PDF 417 Length 2	2710	2710	2710	2710	2710	2710	2710	2710
PDF 417 Read Option	00 (none)	00 (none)	00 (none)	00 (none)	00 (none)	00 (none)	00 (none)	00 (none)

Feature	Default Master	RS-232	RS-232 Wincor-Nixdorf	RS-232 Single Cable	Keyboard	USB COM / USB TEC	USB OEM	IBM Port 17 Port 9B Port 5B
Micro PDF 417 Enable	00 (disable)	00 (disable)	00 (disable)	00 (disable)	00 (disable)	00 (disable)	00 (disable)	00 (disable)
Micro PDF 417 Length Control	00 (variable)	00 (variable)	00 (variable)	00 (variable)	00 (variable)	00 (variable)	00 (variable)	00 (variable)
Set Micro PDF 417 Length 1	0001	0001	0001	0001	0001	0001	0001	0001
Set Micro PDF 417 Length 2	0366	0366	0366	0366	0366	0366	0366	0366
Micro PDF 417 128 Emulation	00 (Micro PDF 417 AIM ID & label type)	00 (Micro PDF 417 AIM ID & label type)	00 (Micro PDF 417 AIM ID & label type)	00 (Micro PDF 417 AIM ID & label type)	00 (Micro PDF 417 AIM ID & label type)	00 (Micro PDF 417 AIM ID & label type)	00 (Micro PDF 417 AIM ID & label type)	00 (Micro PDF 417 AIM ID & label type)
QR Code Enable	00 (disable)	00 (disable)	00 (disable)	00 (disable)	00 (disable)	00 (disable)	00 (disable)	00 (disable)
QR Code Length Control	00 (variable)	00 (variable)	00 (variable)	00 (variable)	00 (variable)	00 (variable)	00 (variable)	00 (variable)
Set QR Code Length 1	0001	0001	0001	0001	0001	0001	0001	0001
Set QR Code Length 2	2710	2710	2710	2710	2710	2710	2710	2710
Micro QR Code Enable	00 (disable)	00 (disable)	00 (disable)	00 (disable)	00 (disable)	00 (disable)	00 (disable)	00 (disable)
Micro QR Code Length Control	00 (variable)	00 (variable)	00 (variable)	00 (variable)	00 (variable)	00 (variable)	00 (variable)	00 (variable)
Set Micro QR Code Length 1	0001	0001	0001	0001	0001	0001	0001	0001
Set Micro QR Code Length 2	3700	3700	3700	3700	3700	3700	3700	3700
Aztec Enable	00 (disable)	00 (disable)	00 (disable)	00 (disable)	00 (disable)	00 (disable)	00 (disable)	00 (disable)
Aztec Length Control	00 (variable)	00 (variable)	00 (variable)	00 (variable)	00 (variable)	00 (variable)	00 (variable)	00 (variable)
Set Aztec Length 1	0001	0001	0001	0001	0001	0001	0001	0001
Set Aztec Length 2	3700	3700	3700	3700	3700	3700	3700	3700

NOTES

Appendix G

Handheld Data Format Requirements

This appendix provides application notes to describe the general format of data that can be accepted by the scanner through the auxiliary port as transmitted from a handheld scanner.

Handheld Data Format Requirements General

- RS232 - 9600 bps, 8 data bits, 1 stop bit, no parity.
- RS-232 RTS is used to “bracket” the data received from the handheld: RTS must be asserted high during data transmission, and de-asserted after label transmission is complete.
No other flow control mechanisms are required or supported.
There must be a delay of at least 2 bit cell times (approximately 208 microseconds) following the transmission of the last character before de-assertion of the RTS signal. The de-assertion of the RTS signal must happen in less than 50 milliseconds after the last character is transmitted.
- USB handhelds enumerate as a CDC ACM serial device.
- USB devices should also bracket the data with the RTS equivalent.
- The time between character transmission can be no longer than 50 milliseconds.
- Symbologies requiring fixed lengths (UPC/EAN) will enforce length requirements for validation of the label.
- Handheld will be required to transmit start and stop characters for Codabar and Code39 labels.
- Appropriate industrial length requirements will be enforced (if configured) for validation of the label.
- Maximum label lengths will be enforced for label validation (i.e. labels longer than the maximum label size will not be validated).
- Standard Datalogic formats generally use a single prefix character. see specific formats section.
- Maximum label size allowed including identifiers is 2714 bytes
- Recommendations:
 - Handheld should not be configured for audible label read indication.
 - Handheld should not be configured for visual label read indication.
 - Handheld should not be configured for continuous label read mode.

Datalogic Handheld Data Format Requirements

The following sections describe label transmission formats that are typically observed in factory configurations of Datalogic handheld scanners.

UPC-A

- Number system must be included in label data
- Check digit must be included in label data and is assumed to be correct
- Prefix must be an ASCII character 'A' - total length including prefix must be 13
- Example: 'A060992011187'

UPC-A with 2-Digit Supplemental

- Number system must be included in label data
- Check digit must be included in label data and is assumed to be correct
- Supplemental data is appended to base label
- Prefix must be an ASCII character 'A' - total length including prefix must be 15
- Example: 'A06099201118712'

UPC-A with 5-Digit Supplemental

- Number system must be included in label data
- Check digit must be included in label data and is assumed to be correct
- Prefix must be an ASCII character 'A' - total length including prefix must be 18
- Example: 'A06099201118712345'

UPC-A with Code128 Supplemental

- Number system must be included in label data
- Check digit must be included in label data and is assumed to be correct
- Supplemental data is appended to base label
- Prefix must be an ASCII character 'A' - total length including prefix must be greater or equal to 19 (code 128 supplemental codes are variable length having a minimum of 2 data characters)
- Characters immediately following base label must be of the form '8100', '8101' or '8102'
- Example: 'A0609920111878100000951'

UPC-E

- Number system must be included in label data
- Check digit must be included in label data and is assumed to be correct
- Prefix must be an ASCII character 'E' - total length including prefix must be 9
- Example: 'E09988750'

UPC-E with 2-Digit Supplemental

- Number system must be included in label data
- Check digit must be included in label data and is assumed to be correct
- Supplemental data is appended to base label
- Prefix must be an ASCII character 'E' - total length including prefix must be 11
- Example: 'E0998875012'

UPC-E with 5-Digit Supplemental

- Number system must be included in label data
- Check digit must be included in label data and is assumed to be correct
- Prefix must be an ASCII character 'E' - total length including prefix must be 14
- Example: 'E0998875012345'

UPC-E with Code128 Supplemental

- Number system must be included in label data
- Check digit must be included in label data and is assumed to be correct
- Supplemental data is appended to base label
- Prefix must be an ASCII character 'E' - total length including prefix must be greater or equal to 15 (code 128 supplemental codes are variable length having a minimum of 2 data characters)
- Characters immediately following base label must be of the form '8100', '8101' or '8102'
- Example: 'E099887508101000951'

EAN8

- Check digit must be included in label data and is assumed to be correct
- Prefix must be an ASCII characters 'FF' - total length including prefix must be 10
- Example: 'FF00210126'

EAN8 with 2-Digit Supplemental

- Check digit must be included in label data and is assumed to be correct
- Supplemental data is appended to base label
- Prefix must be an ASCII characters 'FF' - total length including prefix must be 12
- Example: 'FF0021012612'

EAN8 with 5-Digit Supplemental

- Check digit must be included in label data and is assumed to be correct
- Prefix must be an ASCII characters 'FF' - total length including prefix must be 15
- Example: 'FF0021012612345'

EAN8 with Code128 Supplemental

- Check digit must be included in label data and is assumed to be correct
- Supplemental data is appended to base label
- Prefix must be an ASCII characters ‘FF’ - total length including prefix must be greater than 16 (code 128 supplemental codes are variable length having a minimum of 2 data characters)
- Characters immediately following base label must be of the form ‘8100’, ‘8101’ or ‘8102’
- Example: ‘FF002101268102000951’

EAN13

- Check digit must be included in label data and is assumed to be correct
- Prefix must be an ASCII character ‘F’ - total length including prefix must be 14
- Example: ‘F1101234567891’

EAN13 with 2-Digit Supplemental

- Check digit must be included in label data and is assumed to be correct
- Supplemental data is appended to base label
- Prefix must be an ASCII character ‘F’ - total length including prefix must be 16
- Example: ‘F110123456789112’

EAN13 with 5-Digit Supplemental

- Check digit must be included in label data and is assumed to be correct
- Prefix must be an ASCII character ‘F’ - total length including prefix must be 19
- Example: ‘F110123456789112345’

EAN13 with Code128 Supplemental

- Check digit must be included in label data and is assumed to be correct
- Supplemental data is appended to base label
- Prefix must be an ASCII character ‘F’ - total length including prefix must be greater or equal to 20 (code 128 supplemental codes are variable length having a minimum of 2 data characters)
- Characters immediately following base label must be of the form ‘8100’, ‘8101’ or ‘8102’
- Example: ‘F1101234567891810000951’

Code 39

- Check character must be included in label data
- Label length including start, stop and check characters and excluding prefix character must meet requirements imposed by the main scanner’s fixed or variable label length control for this symbology type.
- Start and stop characters “*” must be included in label
- Prefix must be an ASCII character ‘*’

-
- Example : ‘**CODE39.TEST*’

Code 39-Pharmacode (Code 32)

- Check character must be included in label data
- Label length including start, stop and check characters and excluding prefix character must meet requirements imposed by the main scanner’s fixed or variable label length control for this symbology type.
- Start and stop characters “**” must be included in label
- Prefix must be an ASCII character ‘p’
- Example: ‘p*123456789*’

Interleaved 2 of 5 (I 2 of 5)

- Check character must be included in label data
- Label length including check characters and excluding prefix character must meet requirements imposed by the main scanner’s fixed or variable label length control for this symbology type.
- Prefix must be an ASCII character ‘i’
- Example: ‘*i0123456789’

Codabar

- Check character must be included in label data
- Label length including check character and excluding prefix character must meet requirements imposed by the main scanner’s fixed or variable label length control for this symbology type.
- Prefix must be an ASCII character ‘%’
- Start stop character sets must meet the matching requirement set forth by the scanner configuration item CI_CBAR_START_STOP_CHAR_MATCH
- Start stop character sets s must be of the form ABCD/ABCD and must be included in the label
- Example: ‘%s\$99.95s’

Code 128

- Prefix must be an ASCII character ‘#’
- Label length excluding prefix character must meet requirements imposed by the main scanner’s fixed or variable label length control for this symbology type.
- Function characters may be transmitted as a hexadecimal value 8x. Where x correlates to function characters 1 thru 4 as follows:
 - x80 = function code 1
 - x81 = function code 2
 - x82 = function code 3
 - x83 = function code 4
- For Code128 programming labels the format is of the general form ‘#/82nnnnn/r ‘ - / 82 is hexadecimal 82 and /r is carriage return
- Example: ‘#Code_128.Test’

MSI Plessey

- Check character must be included in label data
- Label length including check character and excluding prefix character must meet requirements imposed by the main scanner's fixed or variable label length control for this symbology type.
- Prefix must be an ASCII character '@'
- Example: '@144769254'

Code 93

- Prefix must be an ASCII character '&'
- Label length excluding prefix character must meet requirements imposed by the main scanner's fixed or variable label length control for this symbology type.
- Example: '&Code93-test'

GS1 DataBar Omnidirectional

- Prefix must be ASCII characters 'R4'
- Check character must be included in label
- Application identifier "01" must follow the prefix and precede the base label
- Label length excluding prefix characters must be 16 characters.
- Example: 'R40101044123456789'

GS1 DataBar Expanded

- Prefix must be ASCII characters 'R4'
- Label length excluding prefix characters must be at least 1 character. Maximum length is the maximum label size supported by the scanner.
- The format of the label must not be of the same format as RSS-14 (application id '01' & length equal to 16)
- Example: 'R4002900123456789083103001750'

Standard 2 of 5 (S 2 of 5)

- Prefix must be ASCII character 's'
- Label length excluding prefix character must meet requirements imposed by the main scanner's fixed or variable label length control for this symbology type.
- Example 's1234567890'

PDF 417

- Prefix must be ASCII character 'P'
- Label length excluding prefix character cannot exceed 2714 characters +3, or 2717 characters. In addition to this, label length excluding prefix character must meet requirements imposed by the main scanner's fixed or variable label length control for this symbology type.
- Example: 'Ppdf test label'

AIM Formats

AIM specifies a 3-character string that is attached as a prefix to the label data for transmission. Because AIM specifies one identifier for UPCA, UPCE and EAN13 labels, UPCA, UPCE and EAN13 will be received from the handheld and transmitted by the scanner as EAN13. The 'J' character must be the first character received in the label transmission from the handheld.

The following sections describe the prefix strings and identify what specific label characteristics can be supported.

UPC-A

- AIM does not specify UPCA as a separate symbology using this transmission format - labels will be transmitted as EAN13 (refer to section 8.5.4.3).
- Examples: 'JE00060992011187' or 'JE30060992011187'

UPC-E

- AIM does not specify UPCE as a separate symbology using this transmission format - labels will be transmitted as EAN13 (refer to section 8.5.4.3)..
- Examples: 'JE00000000998875' or 'JE30000000998875'

EAN13

- Check digit must be included in label data and is assumed to be correct.
- Prefix must be ASCII characters 'JE0' or 'JE3'.
- Total length including prefix must be 16.
- Examples: 'JE01101234567891' or 'JE31101234567891'.

EAN8

- Check digit must be included in label data and is assumed to be correct.
- Prefix must be ASCII characters 'JE4'.
- Total length including prefix must be 11.
- Example: 'JE400210126'

2-Digit Add-on

- Add-on data is appended to the end of an EAN base label.
- If the main label has an AIM Id prefix with the ASCII characters 'JE0', the add-on data must have an AIM Id prefix with the ASCII characters 'JE1'.
- If the add-on data has an AIM Id prefix, the length of add-on data including AIM Id prefix must be 5.
- If the main label has an AIM Id prefix with the ASCII characters 'JE3', the add-on data does not have an AIM Id prefix.
- If the add-on data does not have an AIM Id prefix, the length of add-on data must be 2.
- Examples: add-on portion is highlighted data is underlined

UPC-A 2-digit add-on	'JE00060992011187JE112'
UPC-E 2-digit add-on	'JE00000000998875JE112'
EAN8 2-digit add-on	'JE400210126JE112'
EAN13 2-digit add-on	'JE01101234567891JE112'
UPC-A 2-digit add-on	'JE3006099201118712'
UPC-E 2-digit add-on	'JE3000000099887512'
EAN13 2-digit add-on	'JE3110123456789112'

5-Digit Add-on

- Add-on data is appended to the end of an EAN base label.
- If the main label has an AIM Id prefix with the ASCII characters 'JE0', the add-on data must have an AIM Id prefix with the ASCII characters 'JE2'.
- If the add-on data has an AIM Id prefix, the length of add-on data including AIM Id prefix must be 8.
- If the main label has an AIM Id prefix with the ASCII characters 'JE3', the add-on data does not have an AIM Id prefix.
- If the add-on data does not have an AIM Id prefix, the length of add-on data must be 5.
- Examples: add-on portion is highlighted data is underlined

UPC-A 5-digit add-on	'JE00060992011187JE212345'
UPC-E 5-digit add-on	'JE00000000998875JE212345'
EAN8 5-digit add-on	'JE400210126JE212345'
EAN13 5-digit add-on	'JE01101234567891JE212345'
UPC-A 5-digit add-on	'JE3006099201118712345'
UPC-E 5-digit add-on	'JE3000000099887512345'
EAN13 5-digit add-on	'JE3110123456789112345'

Code128 Add-on

Code 128 add-on is not supported in the AIM format.

Bookland

- The 'Bookland' / ISBN code will be formatted as a vendor specific AIM label.
- Prefix must be ASCII characters 'JX0'
- Length of label data including prefix is 13.
- Examples: 'JX01234567890'

Code 39

- Check character must be included in label data
- Label length including start, stop and check characters and excluding prefix characters must meet requirements imposed by the main scanner's fixed or variable label length control for this symbology type.
- Start and stop characters "*" must be included in label
- Prefix must be ASCII characters 'JA0' or 'JA1'
- Example: 'JA0*CODE39.TEST*'

Codabar

- Check character must be included in label data
- Label length including check character and excluding prefix characters must meet requirements imposed by the main scanner's fixed or variable label length control for this symbology type.
- Prefix must be ASCII characters 'JF0'
- Start stop character sets must meet the matching requirement set forth by the scanner configuration item CI_CBAR_START_STOP_CHAR_MATCH
- Start stop character sets s must be of the form ABCD/ABCD and must be included in the label
- Example: 'JF0s\$99.95s'

MSI Plessey

- Check character must be included in label data
- Label length including check character and excluding prefix characters must meet requirements imposed by the main scanner's fixed or variable label length control for this symbology type.
- Prefix must be ASCII characters 'JM0'
- Example: 'JM0144769254'

Code 93

- Prefix must be ASCII characters 'JG0'
- Label length excluding prefix characters must meet requirements imposed by the main scanner's fixed or variable label length control for this symbology type.
- Example : 'JG0Code93-test'

GS1 DataBar Omnidirectional

- Prefix must be ASCII characters ‘je0’
- Check character must be included in label
- Application identifier “01” must follow the prefix and precede the base label
- Label length excluding prefix characters must be 16 characters.
- Example: ‘je00101044123456789’

GS1 DataBar Expanded

- Prefix must be ASCII characters ‘je0’
- Label length excluding prefix characters must be at least 1 character. Maximum length is the maximum label size supported by the scanner.
- The format of the label must not be of the same format as RSS-14 (application id & length equal to 16)
- Example: ‘je002900123456789083103001750’

Interleaved 2 of 5 (I 2 of 5)

- Check character must be included in label data
- Label length including check characters and excluding prefix characters must meet requirements imposed by the main scanner’s fixed or variable label length control for this symbology type.
- Prefix must be an ASCII character ‘jI1’ (other prefixes specify different check character properties which are not supported).
- Example: ‘jI10123456789’

Code 128 / EAN 128

- Prefix must be either ASCII characters ‘jC0’, ‘jC1’ or ‘jC2’
- Label length excluding prefix character must meet requirements imposed by the main scanner’s fixed or variable label length control for this symbology type.
- If `CI_EAN128_ENABLED` is TRUE and prefix is ‘jC1’, label will be identified as an EAN128 otherwise it is identified as a Code 128.
- A prefix of ‘jC0’ designates that no function code is present in the 1st or 2nd character position
- A prefix of ‘jC2’ designates that a function code 1 is present in the 2nd character.
- Example : ‘jC0Code_128.Test’

Standard 2 of 5 (S 2 of 5)

- Prefix must be ASCII characters ‘jS0’
- Label length excluding prefix characters must meet requirements imposed by the main scanner’s fixed or variable label length control for this symbology type.
- Example : ‘jS01234567890’

PDF 417

- Prefix must be ASCII characters 'JL0' thru 'JL5' ('0' thru '5' inclusive)
- Label length excluding prefix character must meet requirements imposed by the main scanner's fixed or variable label length control for this symbology type.
- Example : 'JL0pdf_test_label'

Data Matrix

- Prefix must be ASCII characters `jd0' thru 'jd6' ('0' thru '6' inclusive)
- Label length excluding prefix character must meet requirements imposed by the main scanner's fixed or variable label length control for this symbology type.
- Example : `jd0dm_label_test'

Aztec

- Prefix must be ASCII characters `jz0' thru 'jzC' ('0' thru 'C' inclusive 0-9,A-C)
- Label length excluding prefix character must meet requirements imposed by the main scanner's fixed or variable label length control for this symbology type.
- Example : `jz0aztec_label_test'

QR Code

- Prefix must be ASCII characters `jQ0' thru 'jQ6' ('0' thru '6' inclusive)
- Label length excluding prefix character must meet requirements imposed by the main scanner's fixed or variable label length control for this symbology type.
- AIM does not distinguish QR from micor QR so devices may read microQR but transmit and be interpreted as QR.
- Example : `jQ0QR_label_test'

Labels with an "unknown" AIM Id (an AIM Id not specified above)

- If a label is received that does not have an AIM Id specified above, and the first 3 label characters qualify as follows:
 - the first characters is a 'j'
 - the second character is a capital or small letter
 - the third character is a digit
 - then the label type is set to GENERIC_DATA and the "unknown" AIM Id is left appended to the beginning of the label data.

NOTES

ASCII Character Set

The table on this page shows a set of ASCII characters and their corresponding Hex Values. The Hex Values in this table are needed for setting symbology specific label identifiers, as well as enabling custom prefix and suffix characters.

ASCII Char.	Hex No.	ASCII Char.	Hex No.	ASCII Char.	Hex No.	ASCII Char.	Hex No.
NUL	00	SP	20	@	40	'	60
SOH	01	!	21	A	41	a	61
STX	02	"	22	B	42	b	62
ETX	03	#	23	C	43	c	63
EOT	04	\$	24	D	44	d	64
ENQ	05	%	25	E	45	e	65
ACK	06	&	26	F	46	f	66
BEL	07	'	27	G	47	g	67
BS	08	(28	H	48	h	68
HT	09)	29	I	49	i	69
LF	0A	*	2A	J	4A	j	6A
VT	0B	+	2B	K	4B	k	6B
FF	0C	,	2C	L	4C	l	6C
CR	0D	-	2D	M	4D	m	6D
SO	0E	.	2E	N	4E	n	6E
SI	0F	/	2F	O	4F	o	6F
DLE	10	0	30	P	50	p	70
DC1	11	1	31	Q	51	q	71
DC2	12	2	32	R	52	r	72
DC3	13	3	33	S	53	s	73
DC4	14	4	34	T	54	t	74
NAK	15	5	35	U	55	u	75
SYN	16	6	36	V	56	v	76
ETB	17	7	37	W	57	w	77
CAN	18	8	38	X	58	x	78
EM	19	9	39	Y	59	y	79
SUB	1A	:	3A	Z	5A	z	7A
ESC	1B	;	3B	[5B	{	7B
FS	1C	<	3C	\	5C		7C
GS	1D	=	3D]	5D	}	7D
RS	1E	>	3E	^	5E	~	7E
US	1F	?	3F	_	5F	DEL	7F



www.datalogic.com

© 2012-2013 Datalogic ADC, Inc. • All rights reserved. •
Datalogic and the Datalogic logo are registered trademarks of
Datalogic S.p.A. in many countries, including the U.S.A. and the E.U.

Datalogic ADC, Inc.

959 Terry Street | Eugene | OR 97402 | USA
Telephone: (1) 541-683-5700 | Fax: (1) 541-345-7140

