

# NCR RealPOS™ Low Profile Bi-Optic Scanner/Scale (7874)

Release 1.1

## User Guide

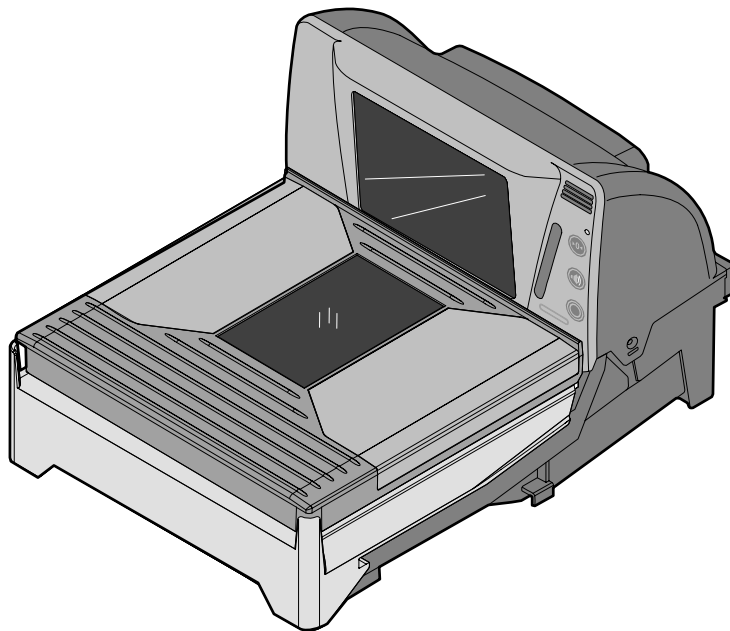

25315

B005-0000-1822  
Issue D

---

The product described in this book is a licensed product of NCR Corporation.

NCR is a registered trademark of NCR Corporation.

NCR RealPOS, NCR RealPrice, NCR RealScan, NCR EasyPoint and NCR FastLane are either registered trademarks or trademarks of NCR Corporation in the United States and/or other countries.

IBM is a registered trademark of IBM Corporation.

Symbol is a registered trademark of Symbol Technologies Incorporated.

Metrologic is a registered trademark of Metrologic Instruments Incorporated.

Sensormatic is a registered trademark of Sensormatic Electronics Corporation.

Checkpoint is a registered trademark of Checkpoint Systems Incorporated.

Mettler Toledo is a registered trademark of Mettler Toledo Corporation.

It is the policy of NCR Corporation (NCR) to improve products as new technology, components, software, and firmware become available. NCR, therefore, reserves the right to change specifications without prior notice.

All features, functions, and operations described herein may not be marketed by NCR in all parts of the world. In some instances, photographs are of equipment prototypes. Therefore, before using this document, consult with your NCR representative or NCR office for information that is applicable and current.

To maintain the quality of our publications, we need your comments on the accuracy, clarity, organization, and value of this book.

Address correspondence to:

Manager, Information Products  
NCR Corporation  
2651 Satellite Blvd.  
Duluth, GA 30096

Copyright © 2009  
By NCR Corporation  
Dayton, Ohio U.S.A.  
All Rights Reserved

# Preface

## Audience

This book is written for hardware installer/service personnel, system integrators, and field engineers.

**Notice:** This document is NCR proprietary information and is not to be disclosed or reproduced without consent.

## References

- *NCR RealPOS Low Profile Bi-Optic Scanner/Scale (7874) Hardware Service Guide*  
(B005-0000-1823)
- *NCR Scanner Programming Tags*  
(BST0-2121-74)
- *NCR Scanner/Scale Interface Programmer's Guide*  
(BD20-1074-A)
- *NCR RealPOS Scanners Safety and Regulatory Information*  
(B005-0000-1699)

# Table of Contents

## Chapter 1: Product Information

Available Models.....	1-2
Features and Options.....	1-2
Bi-Optic Scanning .....	1-2
Communications Protocol .....	1-4
Autodiscrimination.....	1-4
Remote Compact Display .....	1-5
Dual Peripheral RS232 Ports .....	1-5
USB.....	1-7
Firmware Flashing .....	1-7
Operator Interface.....	1-8
Voice Messages .....	1-8
Power Supply .....	1-9
PACESETTER.....	1-9
PACESETTER <i>Plus</i> .....	1-10
PACESETTER III.....	1-10
Parameter Programming .....	1-11
Scan Doctor Diagnostics .....	1-11
Power-on Wellness Check .....	1-12
Ongoing Wellness Check.....	1-12
Service Diagnostics.....	1-12
Soft Power Down/Power Up.....	1-12

## Chapter 2: Site Preparation

Customer Responsibilities.....	2-1
Preparing the Site .....	2-2
Weight.....	2-3
Scanner Dimensions.....	2-3
Checkstand Cutout.....	2-4
7874-3000/3020 (35.3 cm / 13.9 inch).....	2-4
7874-3000/4xxx/5xxx (15.7 inch).....	2-5
7874-3000 When Third-Party Scale Attached.....	2-5
7874-4xxx/5xxx with F030 / K002 (40.6 cm / 16 inch).....	2-6
7874-4xxx/5xxx with 7874-K200 (50.8 cm / 20 inch) .....	2-7
With Side Rails .....	2-7

No Side Rails .....	2-8
Checkstand Wiring .....	2-9
Power Considerations .....	2-10
Power Transient Protection .....	2-10
Cable Connections .....	2-10
Service Clearance .....	2-11
Environmental Considerations .....	2-12
Ventilation Requirements .....	2-12
RealScan 25 Compact Display Dimensions .....	2-13

### Chapter 3: Installation

Installation Steps .....	3-2
Step 1: Verify Installation Preparation .....	3-2
Reporting a Damaged Unit .....	3-2
Package Contents .....	3-2
Step 2: Cable Installation Preparation .....	3-3
Step 3: Sensormatic® Coil Installation .....	3-4
Step 4: Cable Connection .....	3-9
Step 5: 7874 Installation in Checkstand Cutout .....	3-11
Step 6: Top Plate Alignment Verification .....	3-12
Step 7: Scale Calibration .....	3-12
Perform the Calibration Procedure .....	3-13
Increasing Load Test .....	3-21
Over-Capacity Test .....	3-21
Decreasing Load Test .....	3-22
Shift Test .....	3-23
Securing the Calibration Switch .....	3-24
Step 8: Sensormatic® Deactivation Setup .....	3-26
Sensormatic Tag Deactivation .....	3-26
Sensormatic® Online Offline Indication .....	3-26
Specific Function Programming .....	3-28
Power-up the System .....	3-32
Check Sensormatic® Deactivation System .....	3-33
Step 9: Operational Unit Verification .....	3-34
NCR 7874 Scanner-Only Models .....	3-34
NCR 7874 Scanner/Scale Models .....	3-34
7874 Power-On Wellness Check .....	3-35
Checkout Reading Operation .....	3-35
Flash Latest Firmware .....	3-35

Special Host Terminal Connections.....	3-36
Scanner Connected to IBM Terminals.....	3-36
SNI Beetle Host Terminal .....	3-36
Peripheral Connections .....	3-37
Metrologic Hand-Held Scanner.....	3-37
Programming the Metrologic Hand-Held Scanner if Connected through the Auxiliary RS232 Port .....	3-38
Programming the 7874.....	3-41
NCR 2357 and Hand-Held Products (Honeywell) Type Hand-Held Scanner .....	3-42
Programming Hand-Held Products Scanner if Connected through the Auxiliary RS232 Port .....	3-42
Programming the 7874.....	3-43
Programming NCR 2357 Hand-Held Scanner if Connected through the USB Peripheral Port .....	3-44
NCR 2356 and Symbol (Motorola) Type Hand-Held Scanner .....	3-45
Programming the NCR 2356 Hand-Held if Connected through the Auxiliary RS232 Port .....	3-45
Programming the 7874.....	3-46
Programming NCR 2356 Hand-Held Scanner if Connected through the USB Peripheral Port .....	3-47
NCR 2356-4278 Wireless Hand-Held Scanner .....	3-49
Programming the NCR 2356 Wireless Hand-Held Scanner.....	3-49
Programming the 7874.....	3-50

#### **Chapter 4: Operation**

System Components .....	4-2
Operator Display Panel.....	4-2
Motion Detector .....	4-2
Scan Adviser Status Indicator.....	4-3
Scale Zero Button.....	4-4
Volume Adjust Button .....	4-4
Manual Deactivation Button.....	4-5
Remote Compact Display .....	4-6
Scan Adviser LED Scanner State Indicators.....	4-7
Speaker .....	4-8
Vertical and Horizontal Scan Windows .....	4-8
Top Plate.....	4-9
Label Orientation.....	4-10
Active Scan Zone.....	4-10

Multiple Reads .....	4-10
Operating Instructions.....	4-11
Turning the 7874 On and Off .....	4-11
Scanner Only Model.....	4-11
Scanner/Scale Model .....	4-11
Scanning Procedure .....	4-12
Weighing Procedure.....	4-12
Sensormatic® Security Tag Deactivation Procedure .....	4-13
Normal Operation .....	4-13
Manual Deactivation.....	4-14
Adjusting the Good Read Tone.....	4-14
Not-On-File Error.....	4-15
Cleaning Instructions.....	4-16
Scanner Body .....	4-16
Vertical Scan Window .....	4-16
Top Plate and Horizontal Scan Window .....	4-16

### Chapter 5: Programming

Programming Description.....	5-2
Creating the Program .....	5-2
Write the Program .....	5-2
Enter the Program .....	5-2
Save the Program.....	5-3
Programming Tags .....	5-3
ABORT .....	5-3
DEFAULT .....	5-4
END .....	5-5
HEX 0-HEX F.....	5-5
PROGRAM MODE.....	5-5
SAVE AND RESET .....	5-6
SPEAK BAR CODES CURRENTLY ENABLED.....	5-6
Indication.....	5-6
SPEAK SCANNER SERIAL NUMBER.....	5-6
Indication.....	5-6
Program Entry Procedure.....	5-7
Enter All Parameters .....	5-7
Enter Specific Parameters (Shortcut Method) .....	5-9
Parameter Defaults .....	5-11
Programming Tips.....	5-17

---

Program Parameter Descriptions .....	5-18
Communications Protocol .....	5-18
IBM Slot Scanner .....	5-18
IBM USB .....	5-18
NCR (RS232 USB) .....	5-18
RS232 .....	5-19
Good Read Tone .....	5-19
Tone On/Off .....	5-20
Tone Frequency (Hertz) .....	5-20
Tone Length (Milliseconds) .....	5-20
Tone Volume .....	5-20
Not-On-File Volume .....	5-21
Timers .....	5-22
Lockout Time .....	5-22
Restart Lockout Timer .....	5-23
Active Time .....	5-23
900ms Lockout Timer Restart Limit .....	5-23
Bar Codes-1 .....	5-24
UPC/EAN .....	5-24
Extend UPC-A to EAN-13 .....	5-25
Extend UPC-E to UPC-A .....	5-25
Add-On Bar Codes .....	5-25
Add-On Code Length .....	5-25
Send Data .....	5-25
Set 2 Tag Label .....	5-25
Bar Codes-2 .....	5-26
Code 39 .....	5-26
Minimum Characters .....	5-27
Full ASCII .....	5-27
Check Digit Present .....	5-27
Transmit Check Digit .....	5-27
Allow 1- or 2-Character Tags .....	5-27
Code 39 Tone .....	5-27
Tone Length .....	5-28
Tone Frequency .....	5-28
Code 39 Halves Enable .....	5-28
Code 39 Stitch Enable .....	5-28
Code 39 Stitch Check Digit .....	5-29
Check Digit Length1 and Length2 .....	5-29



Scans Required.....	5-29
Overlap Characters.....	5-29
Minimum Segment Size.....	5-29
Bar Codes-3 .....	5-30
Interleaved 2 of 5 .....	5-30
Bar Code Length.....	5-31
Value 1 and 2.....	5-31
Check Digit Present.....	5-31
Transmit Check Digit.....	5-31
Interleaved 2 of 5 Tone.....	5-32
Tone Length.....	5-32
Tone Frequency.....	5-32
Interleaved 2 of 5 Check Digit Length1 .....	5-32
Interleaved 2 of 5 Check Digit Length2.....	5-32
Enable Interleaved 2 of 5 Stitching.....	5-33
Scans Required.....	5-33
Overlap Characters.....	5-33
Minimum Segment Size.....	5-33
Bar Codes-4 .....	5-34
Code 128.....	5-34
Code 128 Tone.....	5-34
Tone Length.....	5-35
Tone Frequency.....	5-35
Code 128 Stitch Enable.....	5-35
Scans Required.....	5-35
Overlap Characters.....	5-35
Minimum Segment Size.....	5-36
Bar Codes-5 .....	5-36
GS1 DataBar Enable .....	5-36
Scans Required on GS1 DataBar-14.....	5-37
Scans Required on GS1 DataBar-E .....	5-37
UCC-128 Emulation Mode .....	5-37
Bar Codes-6 .....	5-38
Codabar Check Digit.....	5-38
Codabar Check Digit Transmission.....	5-38
Codabar Tone Length .....	5-39
Codabar Tone Frequency .....	5-39
Codabar Tone.....	5-39
Codabar Halves .....	5-39

---

Codabar Stitch.....	5-40
Number of Codabar Scans Required .....	5-40
Bar Codes-7 .....	5-40
Pharmacode Check Digit Transmission .....	5-40
Label Identifiers .....	5-41
Identifier Type.....	5-41
Common Byte 1 and Common Byte 2 .....	5-42
Bar Code Type.....	5-43
Common Byte.....	5-43
Unique Identifier .....	5-43
RS232 Parameters 1.....	5-44
Baud Rate.....	5-44
Parity .....	5-44
Stop Bits and Character Length.....	5-45
Handshake.....	5-45
RS232 Parameters 2.....	5-46
BCC Options.....	5-46
Interface Control.....	5-47
Check Digit.....	5-47
RS232 Prefix Byte .....	5-47
Prefix Byte.....	5-48
ASCII Code.....	5-48
RS232 Terminator Byte.....	5-48
Terminator Byte .....	5-49
ASCII Code.....	5-49
RS232 Communications Options .....	5-49
Message Delay .....	5-50
Scanner/Scale Format.....	5-50
Normal or Eavesdrop Mode .....	5-51
Good Weigh Tone.....	5-51
Scale Parameters .....	5-51
Model .....	5-51
IBM Address.....	5-52
Miscellaneous Parameters .....	5-52
Host Tone Control .....	5-52
IBM Retransmit Control .....	5-53
Enable/Disable Voice Messages.....	5-53
IBM-485 / IBM-USB Tag Data Format .....	5-54
Number System Character Parameter .....	5-54

---

Dual Cable Interface .....	5-55
Avery Scale Emulation.....	5-55
Programming Worksheets .....	5-56
Communications Protocol .....	5-56
Good Read Tone.....	5-57
Timers .....	5-58
Bar Codes-1 .....	5-59
Bar Codes-2 .....	5-60
Bar Codes-3 .....	5-61
Bar Codes-4 .....	5-62
Bar Codes-5 .....	5-63
Bar Codes-6 .....	5-64
Bar Codes-7 .....	5-64
Label Identifiers .....	5-65
Number System Character .....	5-66
Sensormatic Deactivation Tone Frequency .....	5-66
Sensormatic Deactivation Tone Pulse .....	5-66
RS232 Parameters 1.....	5-67
RS232 Parameters 2.....	5-68
RS232 Prefix Byte .....	5-69
RS232 Terminator Byte.....	5-69
RS232 Communications Options .....	5-70
Scale Parameters .....	5-70
Miscellaneous Options .....	5-71
Miscellaneous Parameters .....	5-71
Code 128 Tone Length .....	5-71
Code 128 Tone Frequency .....	5-72
Code 128 Tone.....	5-72
Code 128 Minimum and Maximum Tag Length.....	5-72
Code 128 Stitch.....	5-72
Code 39 Tone Length .....	5-73
Code 39 Tone Frequency .....	5-73
Code 39 Tone.....	5-73
Code 39 Quiet Zone.....	5-74
Code 39 InterCharacter Gap Check .....	5-74
Code 39 Halves .....	5-74
Code 39 Stitch.....	5-74
Code 39 CD Length1 .....	5-74
Code 39 CD Length2 .....	5-75

---

Code 39 Minimum and Maximum Length .....	5-75
Interleaved 2 of 5 Tone Length .....	5-75
Interleaved 2 of 5 Tone Frequency .....	5-76
Interleaved 2 of 5 Tone .....	5-76
Interleaved 2 of 5 CD Length1 .....	5-76
Interleaved 2 of 5 CD Length2 .....	5-77
Interleaved 2 of 5 Scans Required .....	5-77
Interleaved 2 of 5 Overlap .....	5-77
Interleaved 2 of 5 Minimum Segment Size .....	5-78
Enable/Disable Interleaved 2 of 5 Partial .....	5-78
GS1 DataBar Tone Length .....	5-78
GS1 DataBar Tone Frequency .....	5-79
GS1 DataBar Tone .....	5-79
GS1 DataBar-E AI 93 to Code 39 Tag Data Conversion .....	5-79
GS1 DataBar-E AI 94 to UCC-128 Tag Data Conversion .....	5-79
GS1 DataBar-E AI 94 to Code-128 Tag Data Conversion .....	5-79
GS1 DataBar-E AI 95 to Interleaved 2 of 5 Tag Data Conversion .....	5-80
Codabar Tone Length .....	5-80
Codabar Tone Frequency .....	5-80
Codabar Tone .....	5-81
Codabar Halves .....	5-81
Codabar Stitch .....	5-81
Codabar Require Start/Stop Match .....	5-81
Codabar Require Quiet Zones .....	5-81
Codabar Start/Stop Transmission .....	5-82
Codabar Hard Correlation .....	5-82
Number of Codabar Overlaps Required .....	5-82
Number of Codabar Scans Required .....	5-82
Number of Coupon Scans Required .....	5-83
Number of UPC/EAN Scans Required .....	5-83
Number of Code 39 Scans Required .....	5-83
Number of Code 128 Scans Required .....	5-84
Number of Code 39 Overlaps Required .....	5-84
Number of Minimum Code 39 Characters in Code 39 Partial .....	5-84
Number of Code 128 Overlaps Required .....	5-84
Number of Minimum Interleaved 2 of 5 Characters in Interleaved 2 of 5 Partial .....	5-85
Number of Minimum Code 128 Characters in Code 128 Partial .....	5-85
Command-type Disable .....	5-85

---

Ignore RS232 Commands from Host Terminal .....	5-85
Enable UPC NS5 Coupon .....	5-86
GS1 DataBar AI 8110 coupons .....	5-86
EAN-13 98 coupons .....	5-86
EAN-13 99 coupons .....	5-86
Expand E to EAN-13 Directly .....	5-86
Checkpoint Interlock.....	5-87
Scanner Power-On State .....	5-87
ASCII Code Chart .....	5-87
Special Programming.....	5-88
Set Current Parameters to Default Values.....	5-88
Enable Soft Defaults .....	5-88
Disable Soft Defaults .....	5-88
Convert UPC-E Tags to EAN-13 Tags .....	5-89
Check Digits on Price Fields.....	5-89
Mandatory 4 Digit Price Check .....	5-89
Mandatory 5 Digit Price Check .....	5-89
Enable/Disable Code-128 Partials.....	5-90
Good Read Tone.....	5-90
GS1 DataBar .....	5-91
GS1 Databar.....	5-91
GS1 Databar-14.....	5-91
GS1 Databar-14 Stacked .....	5-91
GS1 Databar-Expanded.....	5-92
GS1 Databar-Expanded Stacked .....	5-92
Enable/Disable GS1 DataBar .....	5-92
Send GS1 DataBar-14 as EAN-13 Data .....	5-92
Terminal Coupon Interface Parameters.....	5-93
Terminal Coupon Select 1 .....	5-93
Terminal Coupon Select 2 .....	5-94
Voice Messages – Enable/Disable .....	5-94
Voice Volume .....	5-95
Volume Adjust Button .....	5-95
Volume Levels.....	5-96
Enable/Disable Volume Adjust Button .....	5-96
Single Volume Adjust Bar Code.....	5-97
Firmware Flashing .....	5-97
Obtaining the Utility and New Firmware .....	5-97
Acquiring and Installing the RealPOS Scanner Flash Tool for Windows ..	5-97

Acquiring Firmware.....	5-98
Identifying Firmware Version.....	5-99
Firmware Flashing Procedure.....	5-99
NCR RealPOS Scanner Flash Drive Support.....	5-103
NCR RealPOS Scanner Flash Drive Prep Tool.....	5-104
Flash Drive Prep Tool Installation .....	5-104
NCR RealPOS Scanner Flash Drive Prep Tool Functions .....	5-108
Diagnostic Download or Memory Dump .....	5-108
Parameters Upload.....	5-111
Parameters Download .....	5-114
Firmware Upload .....	5-117
Firmware Download.....	5-120
Reset Tallies .....	5-123
Scanner Cloning.....	5-126
File Viewer.....	5-131

### **Chapter 6: Troubleshooting**

7874 Diagnostics and Troubleshooting .....	6-2
Scale Diagnostics.....	6-2
Scale Troubleshooting Codes .....	6-3
Scanner Diagnostic Codes .....	6-4
Isolating Sensormatic® Problems .....	6-5

### **Appendix A: NCR Scanner Programming Tags**

### **Appendix B: Additional Diagnostic Functions**

Scale.....	B-1
Scanner Service Diagnostics.....	B-1

### **Appendix C: Obtaining Information Products**

### **Appendix D: Technical Support**

### **Appendix E: User Feedback**

## Revision Record

Issue	Date	Remarks
A	May 23, 2008	Release 1.1
B	Sept. 19, 2008	Various artwork updates Updated Shift Test and Decreasing Load Test information
C	December 19, 2008	Updated scanner dimensions, checkstand cutout dimensions, and scale calibration test procedures
D	April 17, 2009	Rebranding update
	June 4, 2009	Updated Timers worksheet

## Safety and Regulatory Information

The NCR RealPOS Low Profile Bi-Optic Scanner/Scale (7874) scanner conforms to all applicable legal requirements. To view the compliance statements refer to the *NCR RealPOS Scanners Safety and Regulatory Information* (B005-0000-1699).





# *Chapter 1:* **Product Information**

---

The NCR RealPOS Low Profile Bi-Optic Scanner/Scale (7874) is a state-of-the-art bi-optic scanner. Its primary use is in high-performance checkout areas of food distribution and general merchandise sales. The 7874 can read bar codes on all six sides of the product as it passes through the scan zone. This and other features reduce the amount of operator training and increase operator efficiency.

## Available Models

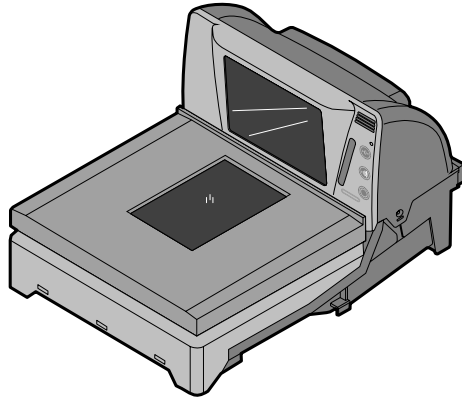

NCR 7874 Scanner/Scale

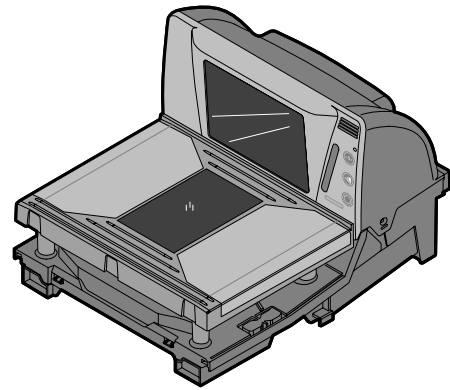

NCR 7874 Scanner Only

25319

The NCR 7874 is available in six RoHS-compliant models. The following table identifies the major models along with a brief description of each.

Model	Description
7874-3000	Third-party scale ready Scanner (sold with a 15.7" top plate)
7874-3020	13.9" Compact Scanner Only
7874-4xxx	15.7" or 16" Scanner Only
7874-5xxx	15.7" or 16" Scanner/Scale
7874-4xxx (Plus 7874-K200)	20" Scanner Only
7874-5xxx (Plus 7874-K200)	20" Scanner/Scale

## Features and Options

The 7874 is rich in features and options which puts it in a class by itself. This section identifies the many features and options that are available.

### Bi-Optic Scanning

The 7874 combines scan patterns from both horizontal and vertical planes. The combination of two scan patterns projecting from different directions permit products to be brought into the scan zone with very little orientation of the bar code. Beginner and veteran checkers learn to use the 7874 very quickly. With minimal training, users attain new levels of efficiency and productivity as they become familiar with the bi-optic scan zone.

The 7874 vertical scan window is mounted to a tower that rises above the checkstand surface. The upper console is designed to withstand constant impact from items being scanned. The horizontal scan window is flush-mounted to a part plastic, part steel top plate, permitting users to slide a product across the top plate without lifting the product. Furthermore, loosely wrapped products cannot snag on the top plate.

Because of its expanded scan zone, the 7874 is very easy to use. It can read labels on all six sides of the product as they pass through the scan zone. Products can be read from right to left or from left to right.

The following is the scan pattern produced on both the vertical and horizontal scan windows.

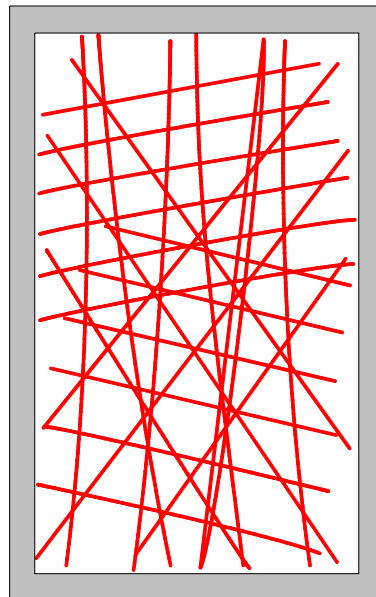

**Horizontal Scan Pattern**

24 scan lines

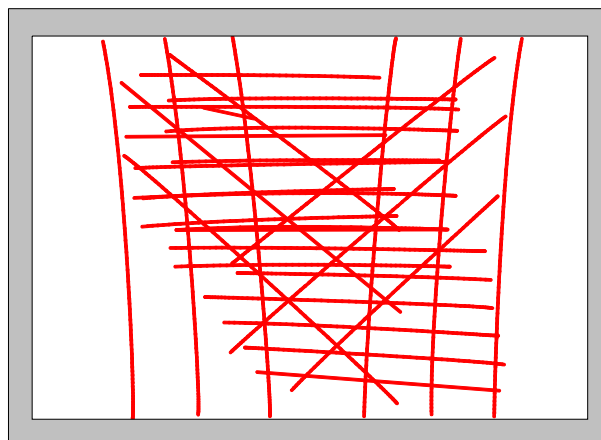

**Vertical Scan Pattern**

30 scan lines

## Communications Protocol

The 7874 communicates with the host terminal through:

- RS232
- USB
- IBM 46xx
- Dual-cable RS232

## Autodiscrimination

The 7874 can decode a variety of bar codes. The ability to discriminate among the different bar code types is a standard feature of the 7874. The following lists the different bar code types.

- UPC-A and UPC-E
- UPC-A and UPC-E with two-digit Add-on Symbols
- UPC-A and UPC-E with five-digit Add-on Symbols
- GS1-128 Coupon Extended Code
- Code 128 Markdown Code
- EAN-8 and EAN-13
- EAN-13 with two-digit Add-on Symbols
- EAN-13 with five-digit Add-on Symbols
- GS1 DataBar, formerly Reduced Space Symbology (RSS)
  - GS1 DataBar-14
  - GS1 DataBar-14 Stacked Omni-directional
  - GS1 DataBar Expanded
  - GS1 DataBar Expanded Stacked
- Interleaved 2 of 5
- Code 39
- Code 39 Full ASCII
- Code 128 (including GS1-128)
- Multi-Stage Dual for Japan
- Codabar
- Pharmacode

## Remote Compact Display

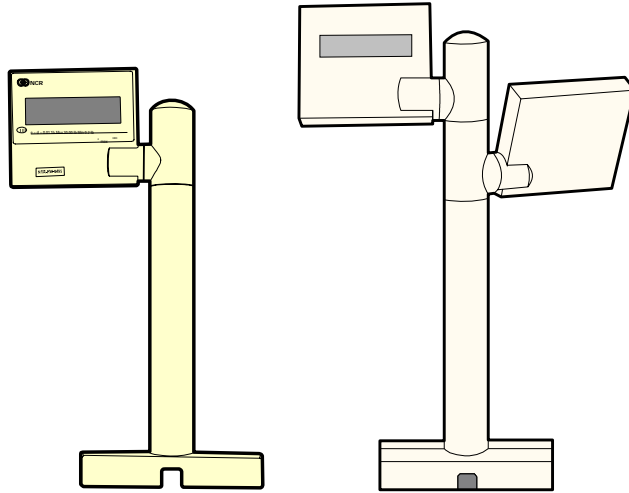

16217

The 7874 Scanner/Scale units are available with no weight display or with a remote post mounted display. When no display is used, scale information is sent to the host terminal and displayed on the host terminal's customer display. However, this is not available for all host terminals, and in some countries Weight and Measures authorities do not permit this configuration.

**Note:** It is acceptable to use the host terminal display if the host terminal is approved to perform the live/gross scale weight. Also, most countries require that both the operator and the consumer must be able to observe the scale live/gross weight display and the sale weight platform during a weighing operation.

When a display is needed, use the RealScan 25 Remote Compact Display. It is available with one or two display modules.

## Dual Peripheral RS232 Ports

The 7874 includes the Dual Peripheral Ports feature. The purpose of this feature is to permit other peripheral devices to connect to the host terminal through the 7874. This eliminates the need of the host terminal having additional RS232 ports.

A typical use of this feature is to connect a hand-held scanner for items too large to place on the checkstand. It also provides a connection for some security tag deactivation systems.

Special programming is required for each peripheral device using a peripheral port. The connector is wired as follows.

Auxiliary RS232 Peripheral Port	
Pin Number	Signal Name
1	+5 Vdc
2	NC
3	GND
4	TXD
5	RXD
6	+12 Vdc
7	CTS
8	RTS

The 7874 Auxiliary RS232 Peripheral Port hardware is limited to the following fixed parameters.

Baud Rate	9600
Parity	Even
Stop Bits	1
Number of Data Bits	7
Hardware Handshaking	Hardware
Terminator Character	CRLF
UPC-A Prefix Character	A
UPC-E Prefix Character	E
EAN 8 Prefix Character	FF
EAN 13 Prefix Character	F
Code 128 Prefix Character	f
Code 39 Prefix Character	a
Interleaved 2 of 5 Prefix Character	b
GS1 Databar (GS1 Databar-14 and Expanded)	r
Codabar	N
Pharmacode	a

The two auxiliary RS232 ports are both located at the back of the unit. Port 1 (located on the right side when facing the rear of the unit) is the most convenient port for connecting a hand-held scanner.

Each peripheral device using a peripheral port requires special programming. The total combined +5V current for the one USB peripheral port and two RS232 auxiliary ports should be less than 750mA. The total combined +12V current for two RS232 auxiliary ports should be less than 350mA.

## USB

The 7874 includes a single USB Peripheral port, a Main (POS) USB Communication Port, and a Main (POS) RS232/RS485 Communication Port. These ports are included to permit easy connections for peripherals and to improve the scanner's capabilities by permitting the devices to be hot-swappable (connecting or disconnecting devices without restarting the unit).

The USB peripheral port is located on the left-most side on the rear of the unit. The purpose of the USB peripheral port is to permit other peripheral devices with IBM SurePOS USB handheld interfaces to connect to the host terminal through the 7874.

The Main (POS) USB and Main (POS) RS232/RS485 Communication Ports are located on the right side at the back of the unit. These ports are used to connect the scanner to the host terminal.

The total combined +5V current for the one USB peripheral port plus two Auxiliary RS232 ports should be less than 750mA. The maximum +5V current for the USB peripheral port should be less than 500mA. The total combined +12V current for two RS232 auxiliary ports should be less than 350mA.

The 7874 is compatible with both the NCR 2356 and NCR 2357 Handheld scanners.

**Note:** Normally, other SurePOS-compliant handheld scanners are compatible with the 7874. However, NCR recommends a thorough integration testing before using any 3rd-party handheld scanner.

## Firmware Flashing

The 7874 includes Firmware Flashing. This permits upgrades to the scanner's firmware. The latest firmware may be downloaded from NCR web site then flashed to the scanner through a PC, host terminal, or a flash drive. The NCR RealPOS Scanner Tool Suite comes in two forms. The first one is free, and the other one provides various Enterprise functions and (sold separately). You can download firmware from the NCR website ([www.ncr.com](http://www.ncr.com))

Refer to the "Firmware Flashing" section in Chapter 5 for more information on firmware flashing.

## Operator Interface

There is very little interface required between the operator and the 7874. Messages are sent from the 7874 to the operator through status indicators on the Operator Display Panel, audio tones, and voice messages.

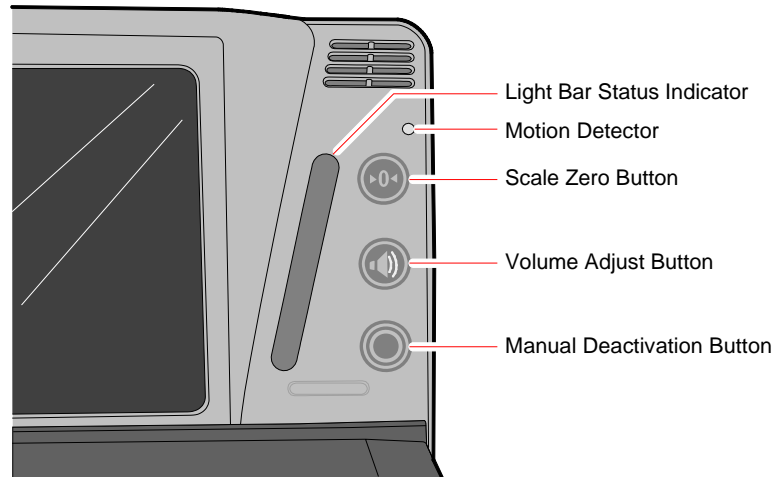

25317

**Note:** Refer to Chapter 4 for more details on the functions of the status indicators and buttons of the Operator Display Panel.

### Voice Messages

If the 7874 has voice enabled, certain mode changes and error conditions are alerted by synthesized voice messages. These messages give either the changed mode or the error message with the suggested corrective action. Voice is enabled and disabled in the Miscellaneous Parameter program.

The scanner provides audible voice messages during the following events.

- When checking the communications protocol (Diagnostic Mode)
- When testing item tags using PACESETTER Plus (Diagnostic Mode)
- When certain error conditions occur
- When there is interference with the scale
- When scanning any programming tag in the Programming Mode



## Power Supply



23756

A green light at the corner of the power supply indicates that the power supply is On.

The optional Power Supply provides the necessary 12V DC voltage required by the 7874 if power is not supplied from the host terminal. The Power Cord plugs into an electrical outlet and connects to the Power Supply. A low voltage Power Cable is integrated with the Power Supply. Several Power Cords are available depending on the country installation. The Power Supply input can be 90 Vac to 264 Vac at a frequency of 47 Hz to 63 Hz.

In addition, some host terminal interface types can power the 7874 without the use of this power supply. Please contact your NCR sales representative for details.

The following table shows the Power Requirement Matrix for the 7874:

7874 Power Requirements Matrix	Power source		
	115Vac	230Vac	12Vdc
Typical Operating Power (Motor and Laser On)	7 W	8 W	6 W
Typical Standby Power (Motor and Laser off)	3 W	4 W	2 W

## PACESETTER

NCR has continually improved its PACESETTER technology used on NCR scanner products. Starting out as PACESETTER, it progressed to PACESETTER *Plus*, and then to PACESETTER III. Vendors and printers regularly supply products with overprinted, underprinted, or truncated bar codes to the market. Some labels have missing margins. Others may be printed around the corner of packages or on media that wrinkles when picked up. PACESETTER addresses the problems caused by these unreadable labels. PACESETTER III is standard on all 7874 products.

## **PACESETTER *Plus***

PACESETTER *Plus* determines what is wrong with a bar code label, fixes the data, and then transfers the information to the host terminal. It provides information on possible bar code printer problems but is not a bar code specification conformity verifier.

The three modes of PACESETTER Plus operation are summarized in the following paragraphs.

### ***Mode 1–Inquiry***

PACESETTER *Plus* can be used as a management tool by store personnel and chain management to monitor and report the status of label readability. Tally counters are kept for the following.

- Good reads
- No read due to lack of full label (missing bars or folded label)
- Good reads with overprinted bars
- Good reads with underprinted bars
- Missing margins
- Missing print lines

In Mode 1, the tally count displays on the RealScan 25 Remote Compact Display. The percentage of each error type to the good reads tally also displays. All tally counts can be reset to zero.

### ***Mode 2–Demonstration Mode***

In Mode 2, the scanner is offline. Each subsequent scan of a bar code causes the scanner to indicate the status of label readability. The scanner recognizes missing bars in labels, highly overprinted or underprinted labels, missing margins, or a “no read” condition.

### ***Mode 3–Operations***

Mode 3 is the normal operating mode. The scanner can be programmed to add PACESETTER Plus information to the decoded UPC/EAN data. This information describes the label readability. However, the host terminal software must be capable of receiving the extra data. The host terminal software should enable this at a regular interval (for example, Cashier Sign On) and check for the presence of the data if enabled.

## **PACESETTER III**

The PACESETTER III feature of the 7874 Scanner performs many functions that improve the efficiency of the scanner. It determines what is wrong with a bar code and then fixes it. It also keeps track of problems found.

PACESETTER III also detects, corrects, and reports errors discovered in UPC Number System Two and Number System Four labels. These two label types are printed in the store and account for a significant number of unreadable labels due to failures of the in-store printing mechanism. PACESETTER III looks for errors in these labels and learns from each attempted scan. After seeing a particular printing error a number of times, PACESETTER III may determine that an error is present in the label and that the error may be correctable. If the correction capability of PACESETTER III is enabled, the scanner attempts an error-free correction of the label and passes the results to the host terminal. Whenever an error-free correction is not possible, PACESETTER III does not pass label data to the host terminal.

## Parameter Programming

The NCR 7874 may need to be configured to meet specific installation needs. The 7874 uses special programming tags to modify the various programming parameters (refer to Chapter 5). This programming data may be scanned with special tags, sent from a PC with the free tools or remotely through the host terminal using special software (sold separately).

**Note:** NCR does not control or specify the NCR scanner configuration required to support specific host terminal software unless you are using NCR Host Terminal Software. You should consult with your Host Terminal Software vendor or reseller to determine the correct configuration for your NCR scanner.

## Scan Doctor Diagnostics

Scan Doctor is the state-of-the-art diagnostic software included in every 7874. It continually monitors the unit to identify components that are not functioning correctly. It also provides inquiry capability for the host terminal to access specific diagnostic data. Scan Doctor diagnoses the 7874 each time power is applied and continually during operation. When a problem is found, it notifies the operator through patterns of color LEDs on the Scan Adviser (beside the Vertical Window), an error code on the remote display (if attached), and voice messages. It lists the most probable causes first.

Many Scan Doctor statuses are available from the scanner using the NCR RealPOS Scanner Tool Suite (sold separately).

Refer to the *7874 Diagnostics and Troubleshooting* section on chapter 5 for more information.

### Power-on Wellness Check

When power is applied to the 7874, Scan Doctor checks many components of the scanner:

- RAM
- ROM
- EEPROM
- Spinner Motor
- Scale Board
- Laser Diodes
- FPGA
- Scale Hardware

If Scan Doctor finds a problem hindering proper operation of the 7874, it disables the unit; otherwise the problem is identified and operation continues.

### Ongoing Wellness Check

Scan Doctor runs all the time, from the moment the 7874 is turned on. It constantly monitors RAM, the Spinner Motor, Laser Diodes and Scale Hardware.

### Service Diagnostics

Scan Doctor includes service diagnostics for the trained service technician. These go beyond the wellness checks and are accessed through the use of special programming tags. Refer to Appendix B for more information on the Scanner Service Diagnostics Tests.

## Soft Power Down/Power Up

The 7874 senses periods of scanner inactivity. The scanner's soft power down feature extends the life of the 7874 by disabling major portions of the unit, including the laser diodes, spinner motor, and associated electronics. The length of the inactive period prior to the soft power down is user-selected and programmed remotely or through tags.

Scanner power up occurs when the 7874 motion detector detects movement. This detector is located on the operator display panel, to the right of the vertical scan window. The 7874 can also be powered up with the checker signs on the host terminal. This capability assumes appropriate host terminal software.

The 7874 can also be powered up/down by the host terminal software when cashier signs in/out using RS232 communications.

## Chapter 2: Site Preparation

---

### Customer Responsibilities

The NCR customer is responsible in preparing the site for installation of the NCR 7874. The following information is provided to help with this task.

The customer must do or provide the following.

- When required by NCR, provide the NCR Customer Services Representative with appropriate drawings that indicate the following.
  - Location of equipment
  - Site wiring (power and signal, paths, and lengths)
  - Location of other equipment capable of generating large amounts of electrical noise, electromagnetic interference, heat, and so forth
- Provide floor coverings and environmental systems that prevent static electricity build-up and discharge.
- Provide and install necessary power distribution boxes, conduits, grounds, lightning arrestors, and associated hardware.
- Ensure clear space and environmental requirements of the unit are met.
- Make all building alterations necessary to meet wiring and other site requirements.
- Ensure all applicable codes, regulations, and laws (including, but not limited to, electrical, building, safety, and health) are met.
- Provide and install all communication cables, wall jacks, special connectors, and associated hardware.
- Provide and install auxiliary power or other equipment as required.

## Preparing the Site

This document contains information necessary for the preparation of a site conforming to NCR specifications. It is important that the site complies with the requirements specified in this document because, once the equipment has been installed, deficiencies in the site or the problems caused by these deficiencies are much more difficult to detect and correct. Further, failure to comply with these requirements or to take proper steps to protect equipment against risks identified in this document may cause serious damage to the equipment and to the customer's business.

In addition to the need to comply with the requirements specified, electrical wiring and mechanical systems must also comply with all relevant codes, laws, and regulations. It is important that a customer or a customer agent who is very familiar with the special requirements of electronic equipment prepare the site. The responsibility of ensuring that the site is prepared in compliance with this document remains with the customer.

For information and guidance purposes only, a list of Customer Responsibilities is provided, in general terms, of those matters for which the customer is responsible. This list is not intended to be comprehensive, and in no way modifies, alters, or limits the responsibility of the customer for all aspects of adequate site preparation.

No comment, suggestion, or advice offered or not offered about preparation of the site nor any inspection of the site whether before or after preparation is to be taken as approval of the location of the site and equipment or of its preparation, and NCR is not liable in respect of any comment, suggestion, or advice given by its staff or in respect of any failure to give advice.

Finally, only the customer can know the full extent of damage that may be caused to his business by reason of failure of the equipment that is to be installed. For this reason, it is the customer's responsibility to ascertain the extent of any such possible damage to his existing or planned business, and to effect full insurance in respect of it.

## Weight

The weight of the 7874 depends on the model. The following are the installed weights of basic models.

**Note:** Weight of the power supply and power cord are not included.

Model	With Top Plate		Without Top Plate	
	Kilograms	Pounds	Kilograms	Pounds
7874-3000	4.25	9.37	2.90	6.20
7874-3020	4.50	9.90	2.90	6.20
7874-4xxx	4.25	9.37	3.43	7.56
7874-5xxx	5.06	11.15	4.24	9.34
7874-4xxx (Plus 7874-K200)	6.80	15.00	5.95	13.12
7874-5xxx (Plus 7874-K200)	7.61	16.78	6.76	14.90

## Scanner Dimensions

The following are the dimensions on each of the models of the 7874 .

Model	Width	Length	Depth	Height Tower	Depth Tower
7874-3000	11.5 in	13.9 in	4.0 in	5.1 in	5.75 in
	29.2 cm	35.3 cm	10.2 cm	13.0 cm	14.6 cm
7874-3020	11.5 in	13.9 in	4.0 in	5.1 in	5.75 in
	29.2 cm	35.3 cm	10.2 cm	13.0 cm	14.6 cm
7874-4xxx	11.5 in	15.7 in	4.0 in	5.1 in	5.75 in
	29.2 cm	39.9 cm	10.2 cm	13.0 cm	14.6 cm
7874-5xxx	11.5 in	15.7 in	4.0 in	5.1 in	5.75 in
	29.2 cm	39.9 cm	10.2 cm	13.0 cm	14.6 cm
7874-4xxx/5xxx (Plus 7874-K200) with rails	12.08 in	20.0 in	4.0 in	5.1 in	5.75 in
	30.7 cm	50.8 cm	10.2 cm	13.0 cm	14.6 cm
7874-4xxx/5xxx (Plus 7874-K200) without rails	11.5 in	20.0 in	4.0 in	5.1 in	5.75 in
	29.2 cm	50.8 cm	10.2 cm	13.0 cm	14.6 cm

## Checkstand Cutout

When cutting the checkstand hole, be careful to maintain the specified dimensions. The checkstand must be designed to drain large spills of liquids away from the base of the scanner.

NCR recommends that an adjustable plate be placed between the leading edge of the 7874 and the belt on the checkstand.

### 7874-3000/3020 (35.3 cm / 13.9 inch)

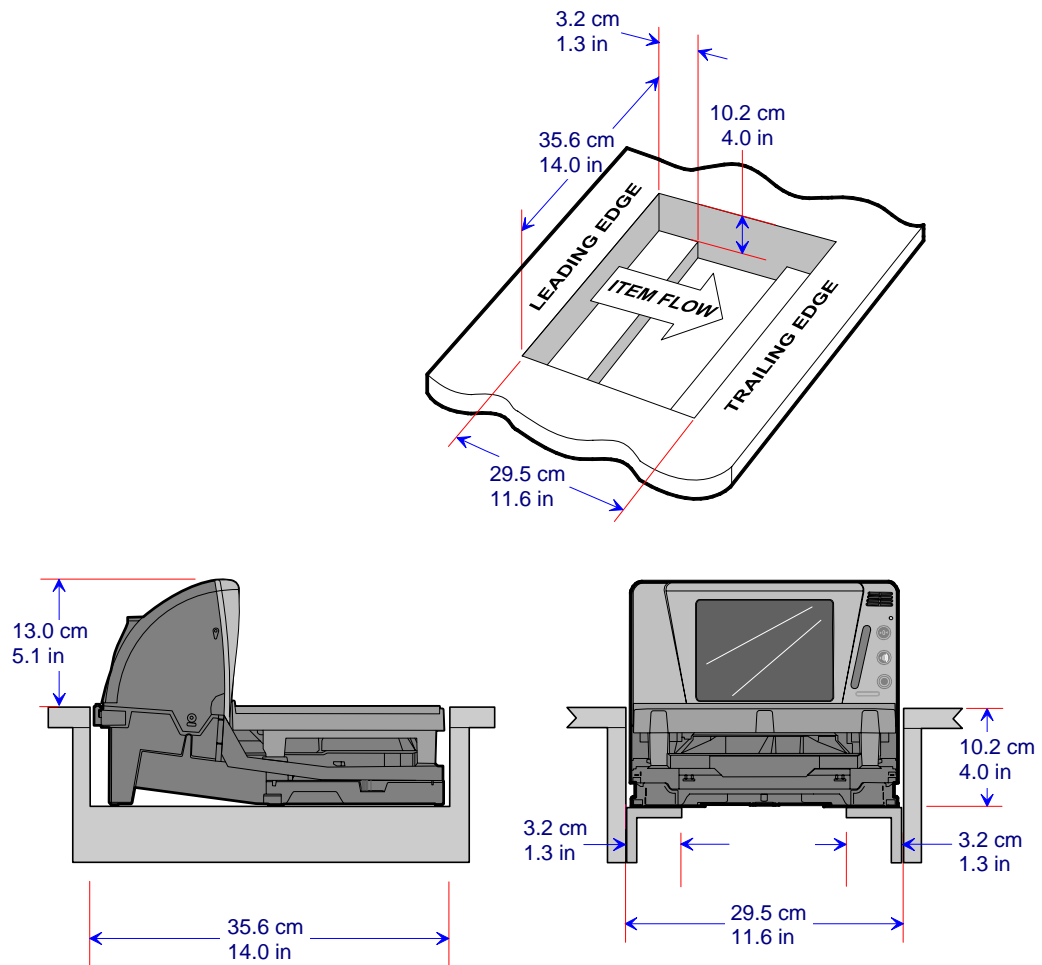

**Note:** Always treat the scanner's profile under the checkstand as a rectangular prism (a flat-sided box) when measuring the checkstand for a fit. Do not take advantage of voids or angles in the design of the scanner base as NCR reserves the right to change the profile without notice as long as the change does not impact overall outside dimensions.



7874-3000/4xxx/5xxx (15.7 inch)

## 7874-3000 When Third-Party Scale Attached

**Note:** See scale vendor for final dimensions where Avery or Bizerba scale is used.

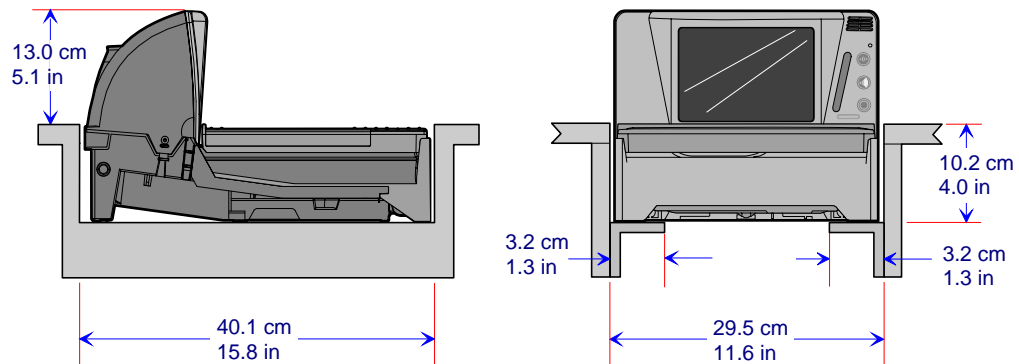
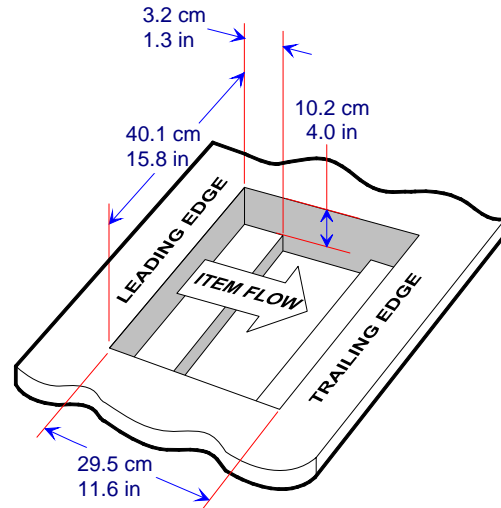

**Note:** Always treat the scanner's profile under the checkstand as a rectangular prism (a flat-sided box) when measuring the checkstand for a fit. Do not take advantage of voids or angles in the design of the scanner base as NCR reserves the right to change the profile without notice as long as the change does not impact overall outside dimensions.

## 7874-4xxx/5xxx with F030 / K002 (40.6 cm / 16 inch)

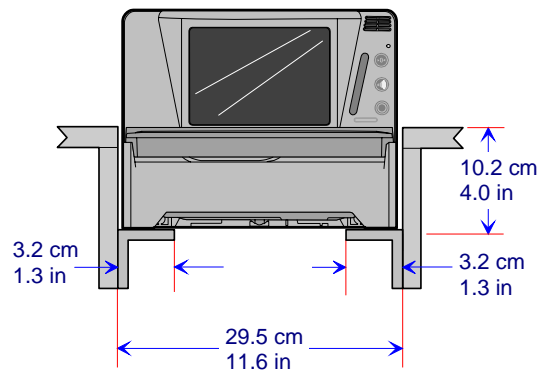
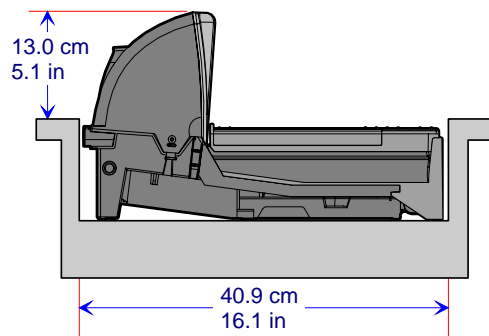
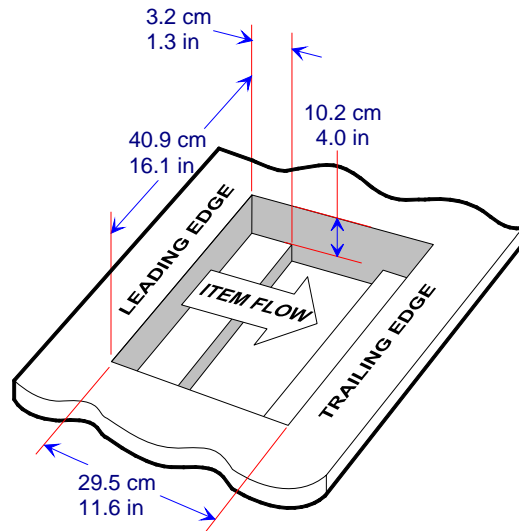

**Note:** Always treat the scanner's profile under the checkstand as a rectangular prism (a flat-sided box) when measuring the checkstand for a fit. Do not take advantage of voids or angles in the design of the scanner base as NCR reserves the right to change the profile without notice as long as the change does not impact overall outside dimensions.

# 7874-4xxx/5xxx with 7874-K200 (50.8 cm / 20 inch)

With Side Rails

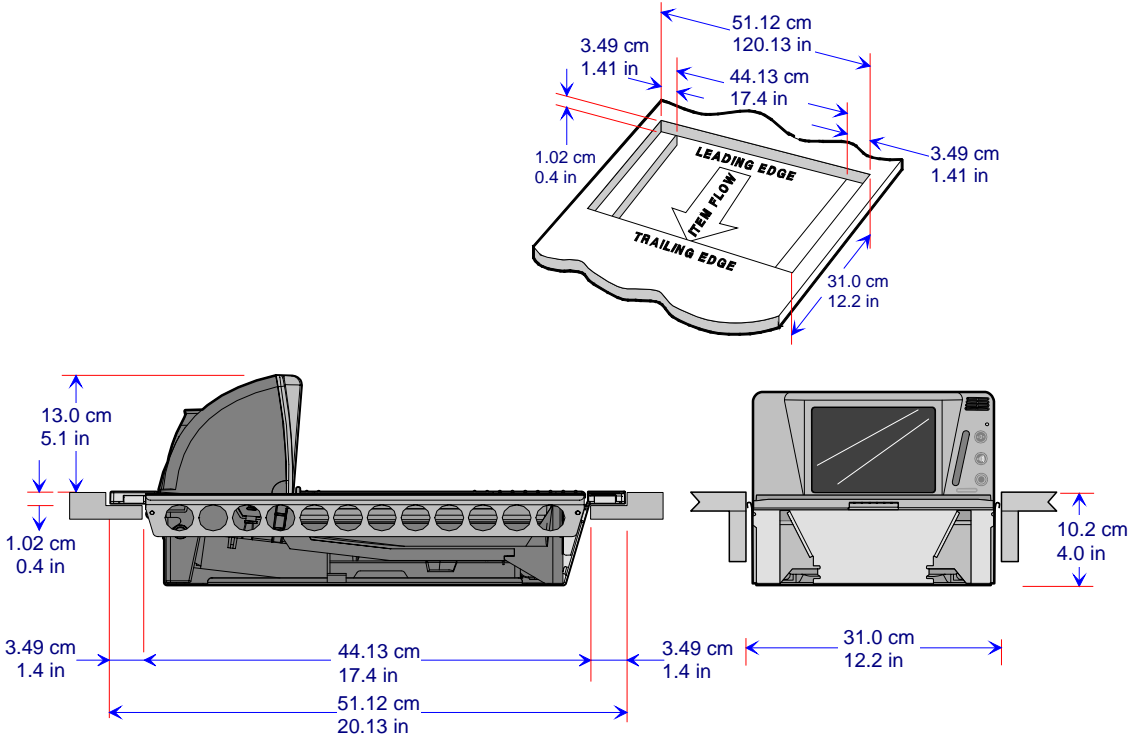

**Note:** Always treat the scanner's profile under the checkstand as a rectangular prism (a flat-sided box) when measuring the checkstand for a fit. Do not take advantage of voids or angles in the design of the scanner base as NCR reserves the right to change the profile without notice as long as the change does not impact overall outside dimensions.

### No Side Rails

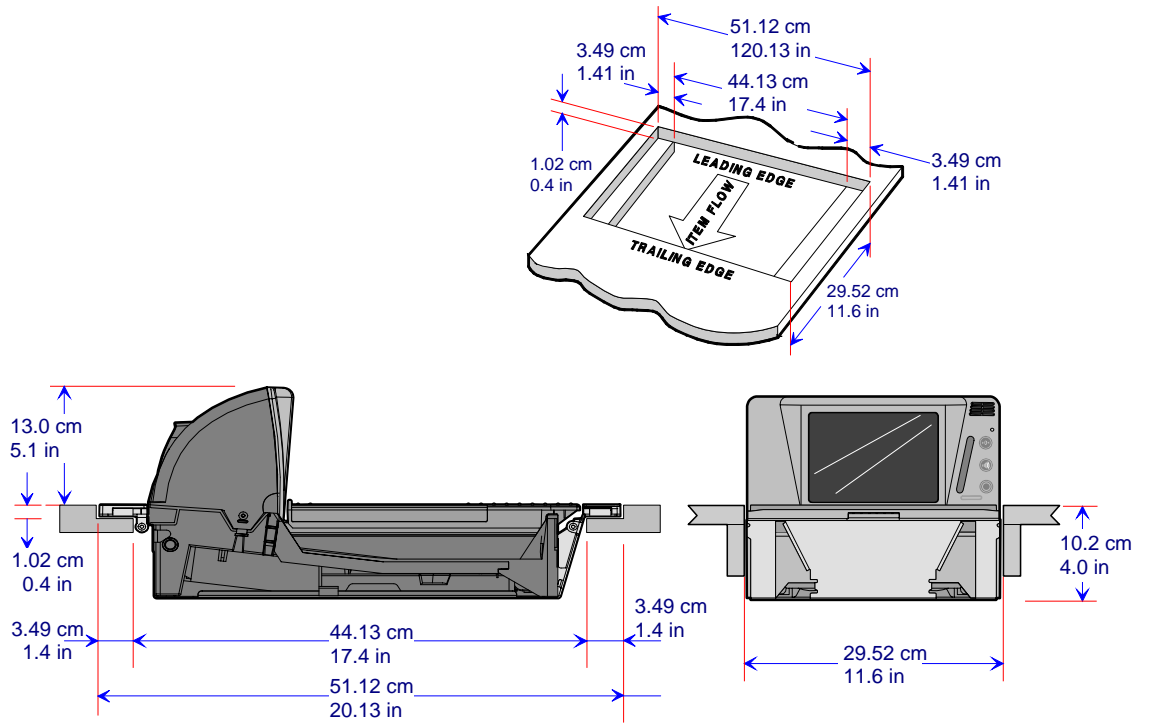

**Note:** Always treat the scanner's profile under the checkstand as a rectangular prism (a flat-sided box) when measuring the checkstand for a fit. Do not take advantage of voids or angles in the design of the scanner base as NCR reserves the right to change the profile without notice as long as the change does not impact overall outside dimensions.

# Checkstand Wiring

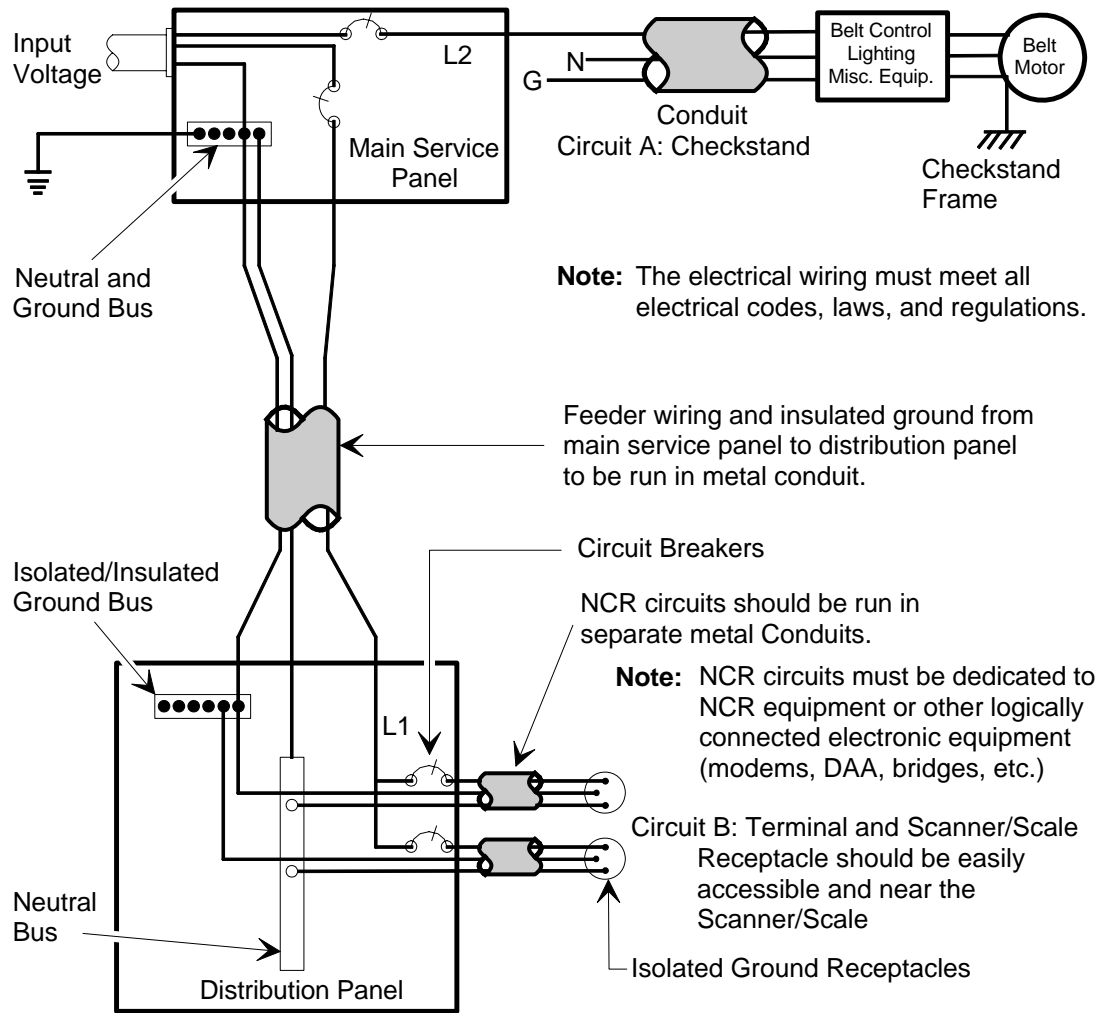

Installation Type	Input Voltage	L1	Circuit Breakers
U.S., Canada, & Japan	100Vac to 120Vac	100Vac to 120Vac	Standard single-pole; value determined by type of device branch and by electrical code.
International	220Vac to 240Vac	220Vac to 240Vac	
European	220Vac	220Vac	European double-pole.

## Power Considerations

The 7874 receives power from an external DC power supply or from +12V DC supplied by the host terminal. The power supply mounts in a remote location close to the 7874. The NCR supplied power supply is a 40-watt switching power supply with the following inputs.

- Voltage: 90 to 264 Vac
- Frequency: 47 to 63 Hz
- Current: 0.9 A

The 7874 has no power switch in the unit, therefore the operator of the 7874 must have a way to remove AC power in the event of an emergency.

The power supply has a green LED which is lit when there is an AC voltage present and the power supply is functioning correctly.

## Power Transient Protection

Voltage transients, surges, sags, impulses, and spikes may be experienced routinely or sporadically. When such phenomena occur, the equipment requires the use of protective devices to ensure proper operation.

## Cable Connections

The following diagram shows the wiring connections located at the rear of the 7874.

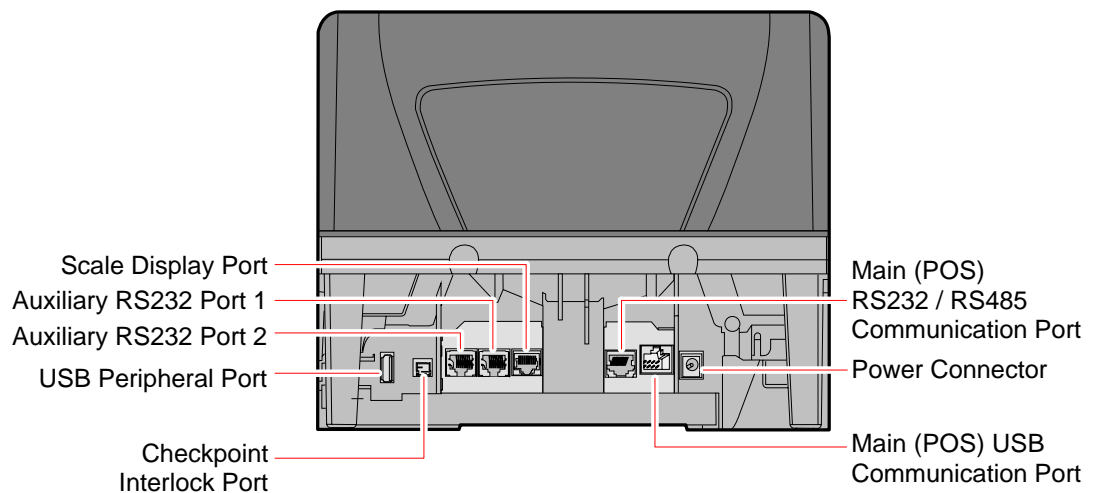

## Service Clearance

Although many of the 7874 components are accessed without removing the unit from the checkstand, service clearance must be provided. Clearance is also required for cleaning the unit. Refer to the following illustration for the required clearances.

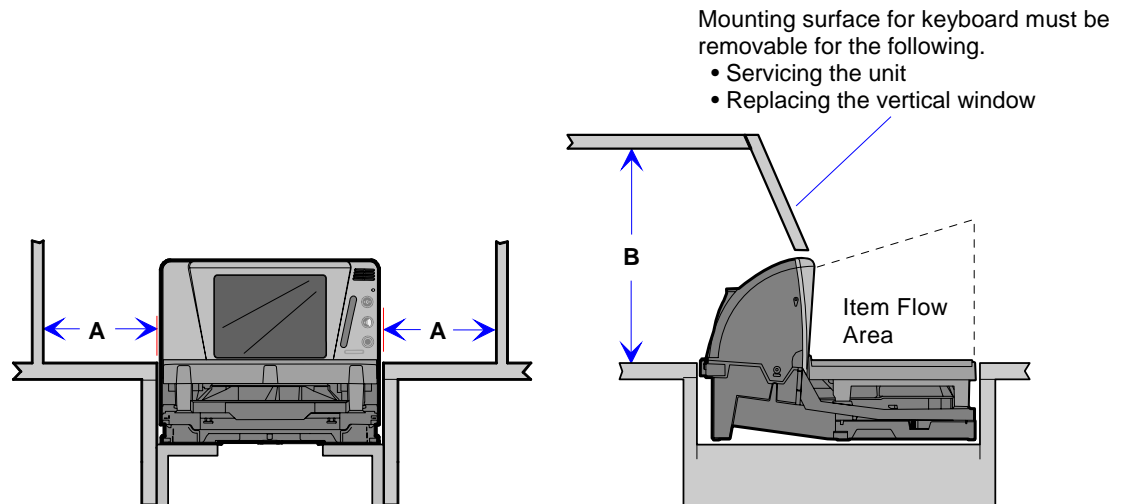

A = 20.32 cm (8.00 in) minimum if checkstand structure is not removable for servicing.  
2.54 cm (1.00 in) minimum if checkstand structure is removable for servicing.

B = 30.73 cm (12.1 in) minimum if checkstand structure is not removable for servicing.  
13.59 mm (5.35 in) minimum if checkstand structure is removable for servicing.

25351

## Environmental Considerations

The 7874 operates in most standard working environments. Temperature ranges permitted are greater when the 7874 is in storage or transit. The 7874 can operate up to one hour at extreme temperatures without suffering damage. The following table gives the various environmental requirements:

Physical Variable	Normal Operating	Extreme Operating (One Hour Maximum)	Storage	Transit
Temperature	5°C-40°C 41°F-104°F	-0°C-45°C 32°F-113°F	-10°C-55°C 14°F-131°F	-40°C-60°C -40°F-140°F
Temperature Change	10°C/hour 18°F/hour	20°C/hour 36°F/hour	20°C/hour 36°F/hour	20°C/hour 36°F/hour
Relative Humidity	20% to 80% Non-condensing	10% to 95% Non-condensing	10% to 90% Non-condensing	5% to 95% Non-condensing
Barometric Pressure	105 x 10 <sup>3</sup> Pa to 79.5 x 10 <sup>3</sup> Pa			105 x 10 <sup>3</sup> Pa to 74 x 10 <sup>3</sup> Pa
Ambient Light	200 Foot-Candles max (2152 Lux) on both scanner windows	200 Foot-Candles max (2152 Lux) on both scanner windows		
Acoustical Noise	65 dBa or less	65 dBa or less		
Vibration	3-150-3 Hz 2.5 g input Base Position	3-150-3 Hz 2.5 g input Base Position		
Shock	$\Delta V = 0.5$ m / sec (20 in / sec) 25g @ 3.75 ms Triangular Pulse	$\Delta V = 0.5$ m / sec (20 in / sec) 25g @ 3.75 ms Triangular Pulse 1 Shockbase Position		

23786

## Ventilation Requirements

If the checkstand contains other heat-producing equipment, forced air may be needed to keep the temperature within the specified range. However, air coming into or leaving the checkstand MUST NOT enter or exit past the 7874.



## RealScan 25 Compact Display Dimensions

The following are dimensions of the RealScan 25 Compact Display. The holes are spaced to align with those of the older RealScan 25 Remote Post Display and with some competitor models.

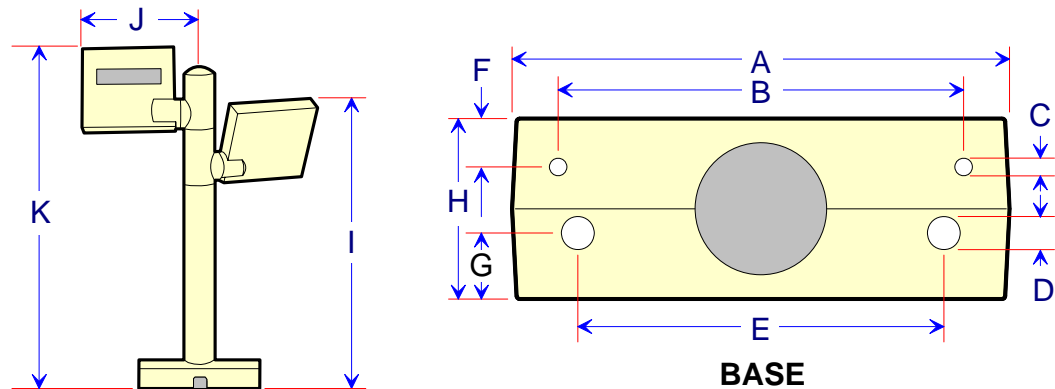

A	B	C	D	E	
115.31 mm	93.98 mm	3.96 mm	7.62 mm	84.83 mm	
4.54 in	3.70 in	0.156 in	0.30 in	3.34 in	
F	G	H	I	J	K
11.17 mm	16.25 mm	41.65 mm	266.19 mm	104.39 mm	314.96 mm
0.44 in	0.64 in	1.64 in	10.48 in	4.11 in	12.4 in

**Note:** Dimension I is also the height of a single-display unit.

24173



## Chapter 3: Installation

---

Installing the 7874 consists of eight main steps. Sometimes additional information is required depending on the installation. Information about enabling special functions is provided in *Programming* chapter.

# Installation Steps

The following are the eight installation steps for installing the 7874.

1. Verify installation preparation (scanner and checkstand)
2. Cable installation preparation
3. Install Sensormatic® or Checkpoint antenna (optional)
4. Connect Cables
5. Put 7874 in checkstand cutout
6. Verify Top Plate alignment
7. Calibrate the scale
8. Setup Sensormatic® or Checkpoint deactivation (applicable only if Sensormatic® or Checkpoint antenna is installed)
9. Verify unit is operational

## Step 1: Verify Installation Preparation

### Reporting a Damaged Unit

After receiving the NCR 7874, inspect the shipping carton for damage. If the 7874 is damaged due to shipping, notify the carrier, the NCR representative, or the supplier if the unit is not purchased directly from NCR.

### Package Contents

After unpacking the 7874, take inventory to ensure that all components are received.

The following list identifies the package contents.

- NCR 7874
- Power Supply (separate package if ordered)
- Power Cord (separate package if ordered)
- Top Plate
- Interface Cable (separate package if ordered)
- Power Cord Documents (for International Units)
- The label which identifies the model number (for example, 7874-4xxx)
- Customer Satisfaction Hotline Details
- NCR RealPOS Scanners Safety and Regulatory Information (B005-0000-1699)

## Step 2: Cable Installation Preparation

**Note:** Before attempting to install the 7874, the site must be prepared in accordance with the requirements described in *Site Preparation* chapter.

**Note:** The 7874 ships complete from the factory and requires no operator assembly. The laser module is an integral part of the factory assembled device and does not have any controls that can increase the level of laser light or collateral radiation from the 7874.

Follow these steps in preparation to install the NCR 7874 cables to the scanner.

1. Verify that the 7874 power receptacle switch is off. Plug the power cord into the 7874 power supply unit. Pass the power cable from the power supply through the checkstand opening.
2. Connect the communications interface cable to the host terminal. Refer to the host terminal documentation for instructions on how to connect the interface cables.

**Note:** Some host terminals may require a trained service technician to open the host terminal and connect the interface cables.

3. Pass the interface cables through the checkstand opening.
4. If connecting a remote display, pass the remote display cable through the checkstand opening.
5. If connecting an RS232 peripheral device below the checkstand, pass its interface cable through the checkstand opening.
6. Place the unit so that a portion of the tower end is directly over the hole in the checkstand.

Skip to “Step 4: Cable Connection” when not installing a 7874 with a Sensormatic® deactivation system.

## Step 3: Sensormatic® Coil Installation

To install the Sensormatic® Coil, perform the following procedure.

1. Position the 7874 facing the operator.
2. Remove the Top Plate.
  - a) Hold the front edge of the Top Plate between your fingers.
  - b) Lift the Top Plate to remove it from the 7874.

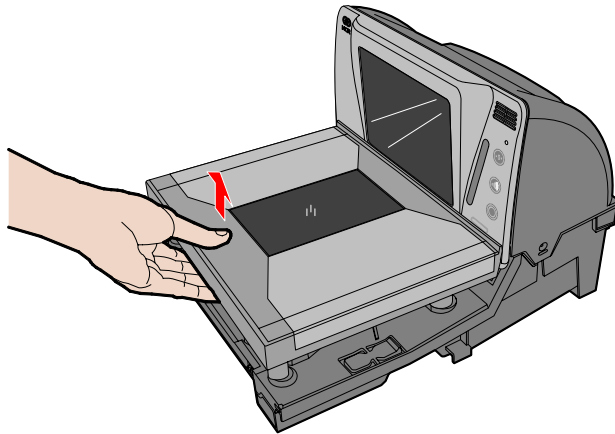

25518

3. Remove the Front Bezel.
  - a) Place one hand and slightly apply downward pressure on the top corner of the Bezel. Use a flat tip screw driver to push the snap features found at the bottom-corner of the Bezel.

**Note:** Do this procedure on both sides of the Bezel to detach it from the scanner.

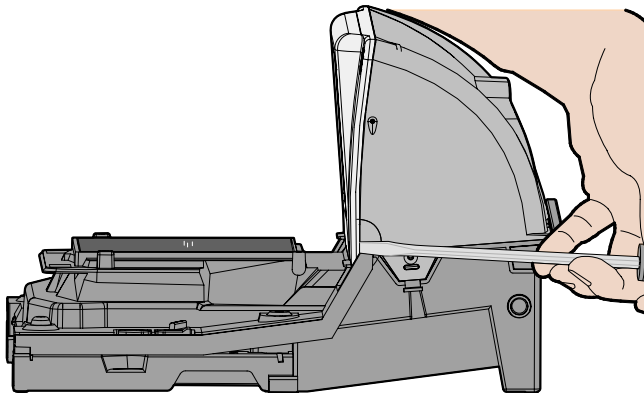

25464

- b) Lift the Bezel up and set aside.

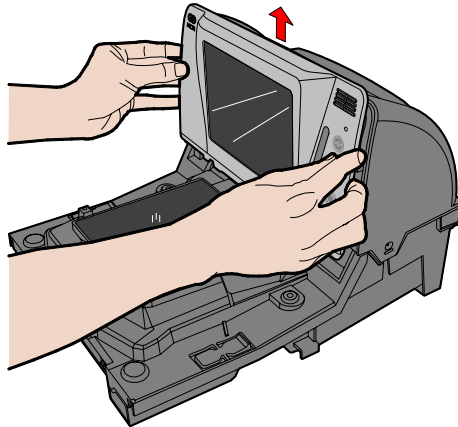

25572

5. Install the Sensormatic® Coil.

- a) Connect the horizontal coil cable and the vertical coil cable as shown.

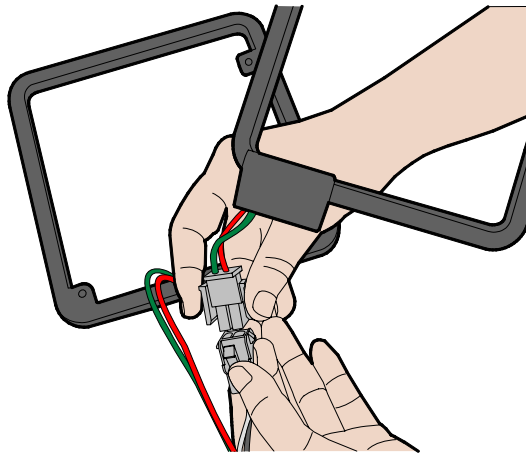

25692

- b) Route the coil cable at the bottom of the tower as shown and press the strain relief into the notch.

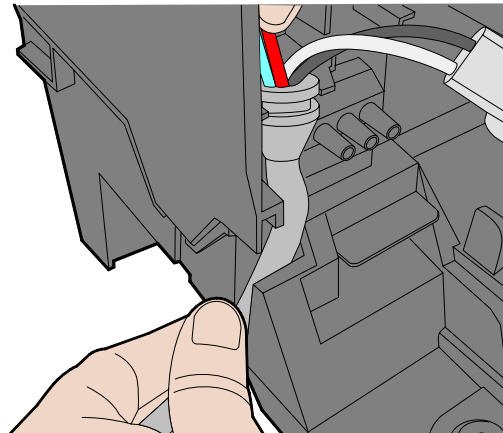

25691

- c) Lay the horizontal coil down and around the horizontal window.

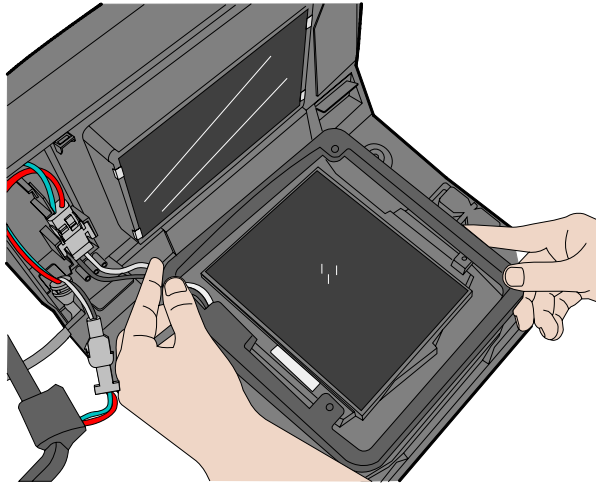

25690

- d) Install the three screws to hold the horizontal coil in place.

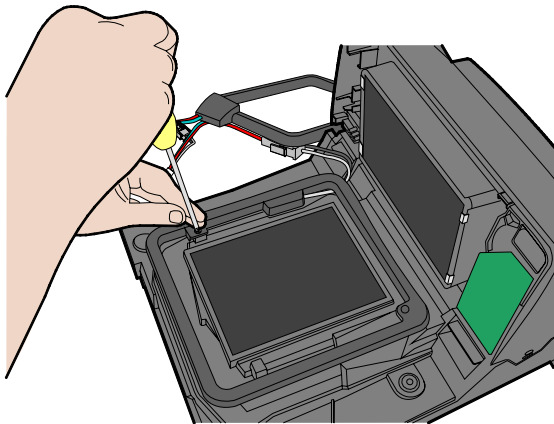

25659

- e) Route the horizontal coil cable on the tower as shown.

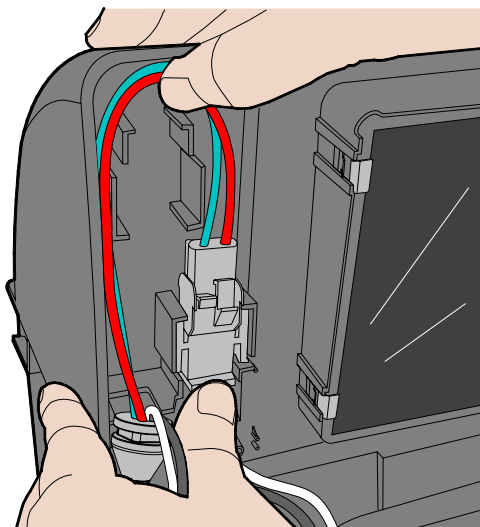

25693



- f) Attach the vertical coil around the vertical window and route the vertical coil cable on the tower as shown.

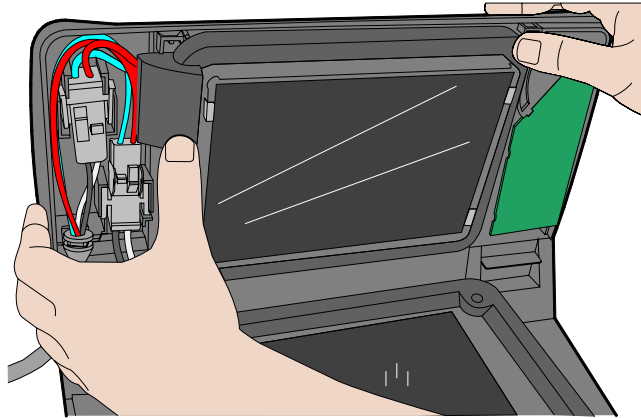

25657

6. Replace the Bezel.

- a) Align the top edge of the Tower Cabinet with the top edge of the Front Bezel.

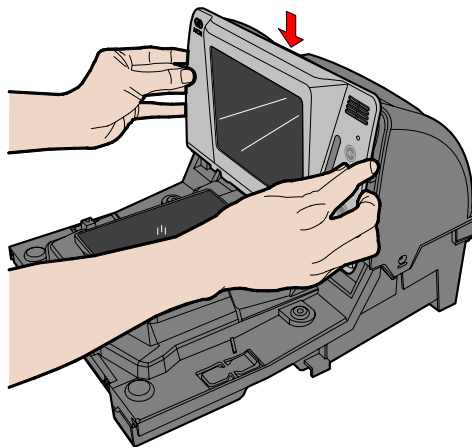

25571

- b) Ensure to route the horizontal coil wires under the notch found on the bottom of the Front Bezel. The scanner will have scale issues if the wires are not routed properly under the Front Bezel.

horizontal wires properly  
routed under the bezel

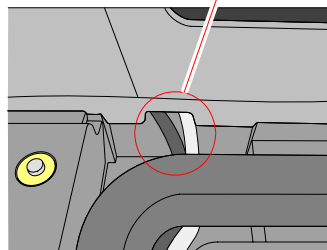

Correct

horizontal wires not properly  
routed under the bezel

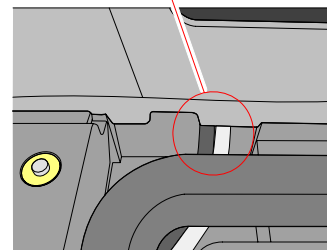

Wrong

25911

- c) Press the bottom-left and bottom-right corners of the Front Bezel towards the tower cabinet to latch it in place.

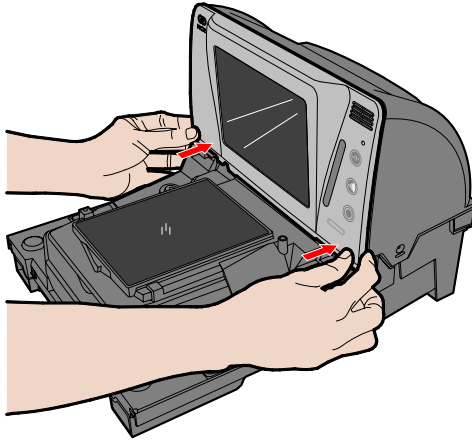

25512

- 7. Replace the Top Plate.
  - a) Holding the front edge of the Top Plate, lay the back edge on the two rear support posts on the 7874.
  - b) Lay the front of the Top Plate down onto the two front support posts.

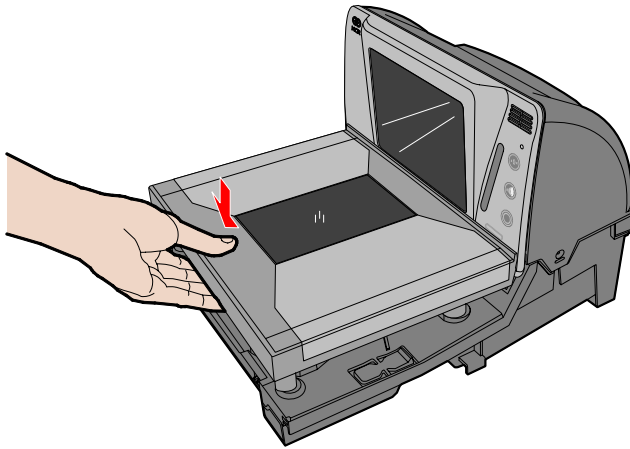

25517

## Step 4: Cable Connection

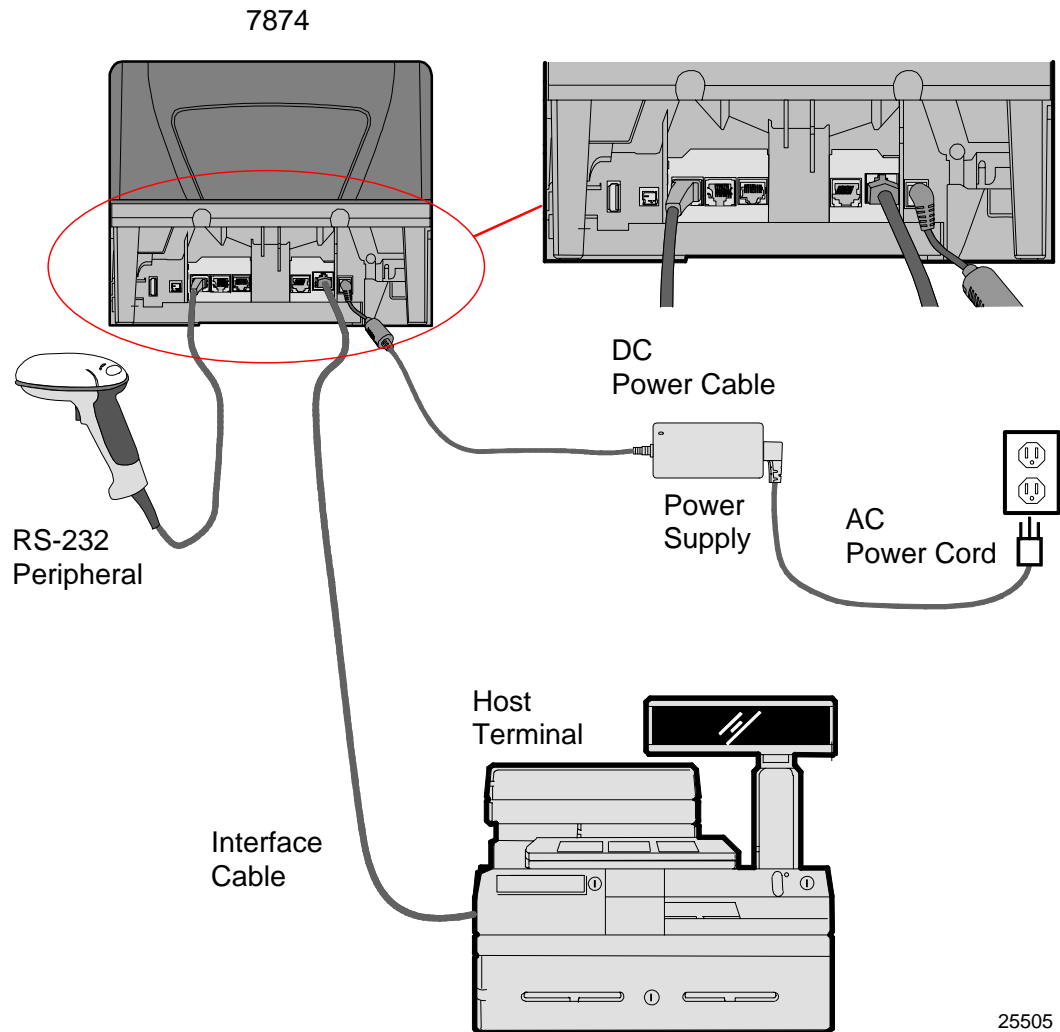

**Note:** Ensure that the power is off before connecting or disconnecting cables. If the scanner is powered by a host terminal, turn off the host terminal. Otherwise, disconnect the AC power from the power brick.

To install the cables in the 7874, perform the following procedure.

1. If used, install the optional Checkpoint® Antenna.
  - a) Remove the Top Plate.
  - b) Remove the Front Bezel.

- c) Route the Checkpoint cable as shown below.

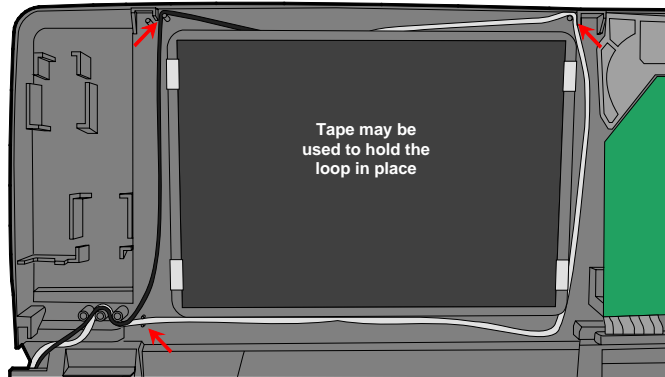

25695

- d) Route the cable out the left side of the unit.

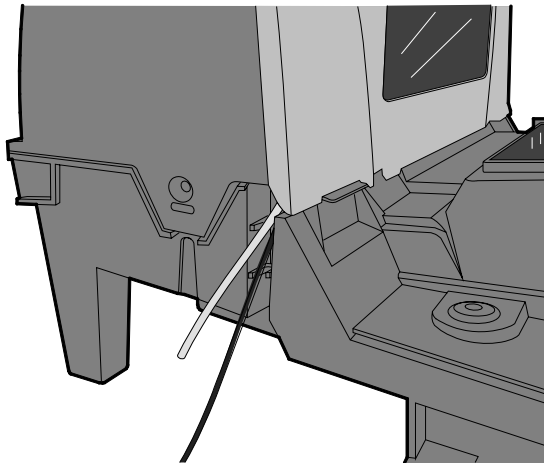

25696

2. If used, connect the optional DC Power Cable from the Power Supply to the DC Power connector.
3. Connect the interface cable to the Scanner connector or the USB + Power Connector.

**Note:** The scanner can connect to a separate “host terminal scale interface cable” through “Port 1”. Full details are added on the firmware's release.

4. If used, connect the remote display cable to the Remote Display connector.
5. If the configuration includes a USB device, connect it to the USB peripheral port.
6. If used, connect one end of the Sensormatic® Communications Cable to the RS232 Port 2 connector at the back of the 7874. The other end connects to the host terminal connector on the Sensormatic® AMB9010 Controller.
7. If used, connect the Sensormatic Coil Cable to the Coil connector on the Sensormatic® AMB9010 Controller.

8. If used, Connect the Sensormatic® AC Power Cord.
9. If used, connect the Checkpoint® interlock cable.
10. Turn on the scanner by turning on the host terminal or by turning on the AC power of the scanner.

**Note:** Some peripherals are limited to which port they can use.

## Step 5: 7874 Installation in Checkstand Cutout

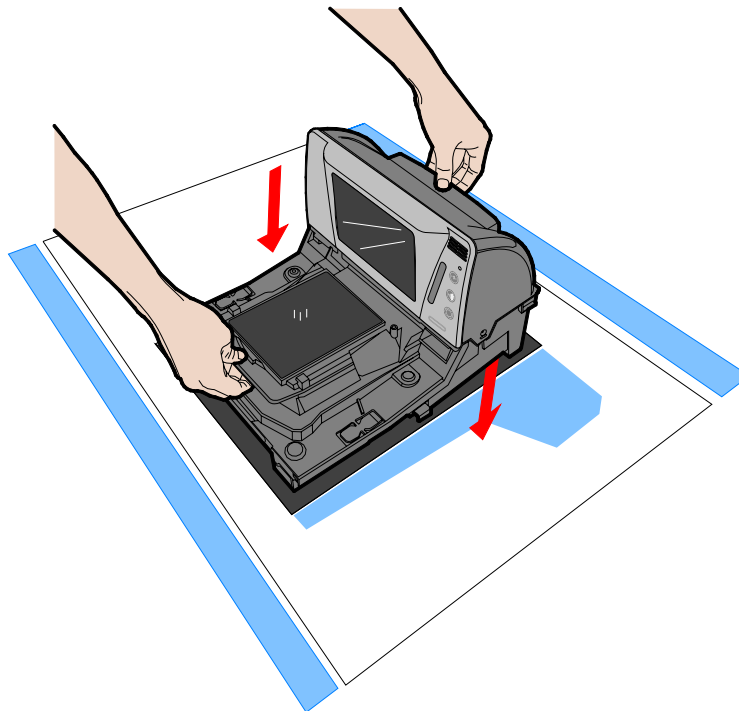

25510

To install the 7874 in the checkstand cutout, perform the following procedure.

1. Verify that the top of the 7874 supports are set to the initial distance from the top of the checkstand. Check dimensions on the “Checkstand Cutout” section in the *Site Preparation* chapter.
2. Holding the handles on the back of the tower cabinet and the front of the unit, slowly lower the 7874 into the checkstand cutout. It should sit on supports at the bottom of the checkstand cutout.
3. Install the Top Plate on the four supports on the scanner.

**Note:** It is important that the 7874 does not rock on its supports. Make sure that all adjustable supports are securely fastened and that the 7874 is sitting on all supports.

**Note:** Place the power supply in a position where spilled liquids cannot fall onto it.

## Step 6: Top Plate Alignment Verification

Verify the final alignment of the Top Plate with the top of the checkstand. The side edges of the Top Plate must not be higher than the top surface of the checkstand.

- For installation of a 7874 scanner only, skip to “Step 8: Operational Unit Verification”.

## Step 7: Scale Calibration

**Note:** Only certified personnel can perform the scale calibration procedure and place the scale into service for trade to comply with governmental weights and measures regulations.

The 7874 must meet the following accuracy requirements.

- The 7874 is considered a new unit each time the scale is calibrated. This status lasts for thirty (30) days.
- The 7874 is considered an in-service unit thirty (30) days after the scale is calibrated.

During factory testing, the scale is calibrated one or more times to test the scale calibrating function. This calibration test is not sufficient to make the scale ready for weighing in trade. The scale **MUST** be calibrated when any of the following occur (this is a government requirement).

- Initial installation of a 7874
- When the scale cannot be zeroed
- When the diagnostics indicate a calibration error
- When the Scale Assembly is changed

The calibration procedure sets the scale and the electronics to interpret the weight of an item accurately. The scale can be calibrated after power has been supplied for 30 minutes and if the ambient air condition has been 20° C (68° F) or above for at least 24 hours. If the ambient air condition has not been met (below 20° C (68° F)), then the scale must be on for at least 6 hours before it can be calibrated. One or more certified weight sets are required to calibrate and certify the scale. The following are examples:

- Whole Pound Weight Set: NCR Part Number 998-0633009
- Fractional Pound Weight Set: NCR Part Number 998-0633012
- Kilogram Weight Set: Obtain locally

The 7874 maintains an audit trail of scale calibration and weighs parameter setting. The audit trail consists of two even counters. Display the audit trail count by pressing and holding the **Scale Zero** button on the Operator Display Panel. The display alternates between Cal xxx and Par xxx. The Cal value is the number of times the scale has been calibrated. The Par value is associated with the weigh parameter setting and should never change.

**Note:** Scanner scale capacity is 30 lb (15 kg) in 0.01 lb (0.005 kg) increments.

**Note:** The audit trail displays only on units with the RealScan 25 Remote Display.

**Note:** Some host terminals can corrupt the calibration settings if they are connected during scale calibration. Therefore, NCR recommends disconnecting the interface cable before starting calibration of the scale and then reconnect it after completing the calibration procedure.

### Perform the Calibration Procedure

**Note:** If a protective plastic covering is present on the Top Plate or the clear plastic door below the Top Plate, ensure that it is removed before calibrating the Scale.

The scale firmware controls the calibration procedure. It waits for a response to each prompt before going to the next step. The firmware uses the voice feature and the display to identify how much weight to place on the Top Plate. After the required weight has been placed on the Top Plate and the Scale Zero button is pressed, the firmware sounds a single tone and goes to the next prompt.

The calibration procedure can be ended before completion by turning the unit off. However, if this is done, the scale must still be calibrated before placing it into service.

**Note:** The pound and kilogram weights used for calibration are not equivalent values. They are the actual weights the firmware needs to perform the calibration.

**Note:** Turn off the EAS system during scale calibration.

### *Calibrating and Exercising the 7874*

1. Determine the type of weight set to use for calibration. There are two weight sets, Kilograms and Pounds.
  - For the **Kilogram** weight set, you must have a calibrated KG weight set, 12.5 KG total. Weight combinations 2.5kg, 7.5kg, and 12.5kg are required, with suggested individual weights made up of a set of two 5 kg weights, one 2kg weight, and one 500g weight.
  - For the **Pound** weight set, you must have a calibrated LB weight set, 30 pounds total. Weight combinations 5 lb, 15 lb, and 30 lb are required, with suggested individual weights made up of a set of two 10 lb weights, one 5 lb weight, two 2 lb weights, and one 1 lb weight.
2. Apply power to the 7874 if it is off. The unit needs to be ON for 30 minutes prior to calibration, unless it is cool in the environment (below 20° C (68° F)), in which case the scale must be on for at least 6 hours before it can be calibrated.
3. EXERCISE THE SCALE

**Note:** You MUST exercise the scale BEFORE the scale can be calibrated

- a. Remove the Top Plate.
- b. Press the Calibration Switch.
  - i. Remove the clear plastic Switch Cover located on the right-front corner of the unit. Lift the left side of the cover to unlatch and remove it.

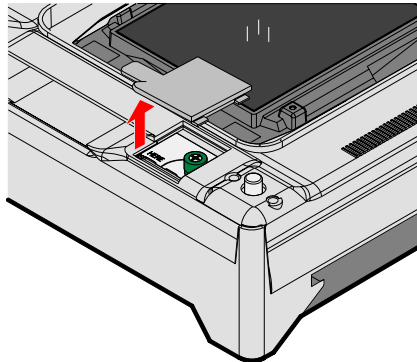

25918

If the Calibration Switch Security Cover is secured with a lead/wire or paper seal, remove the seal.



- ii. Unscrew the green sealing screw and pull up on the cover to access the blue Calibration Switch button.

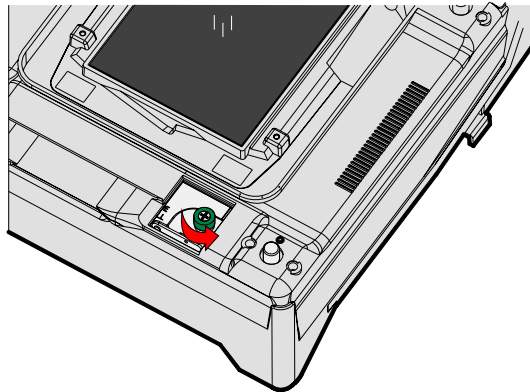

25917

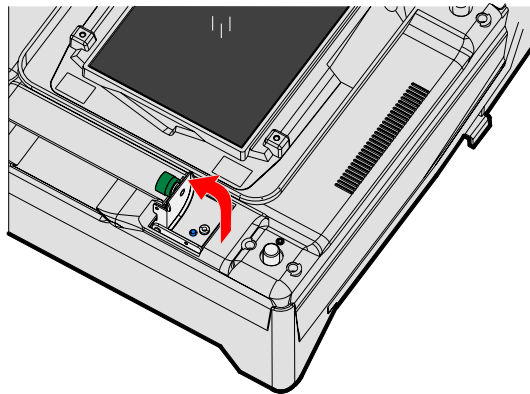

25915

- iii. Press the small blue Calibration Switch button (this button is very small and very recessed). When you press the button, the scanner speaks “**Press Deck**”.

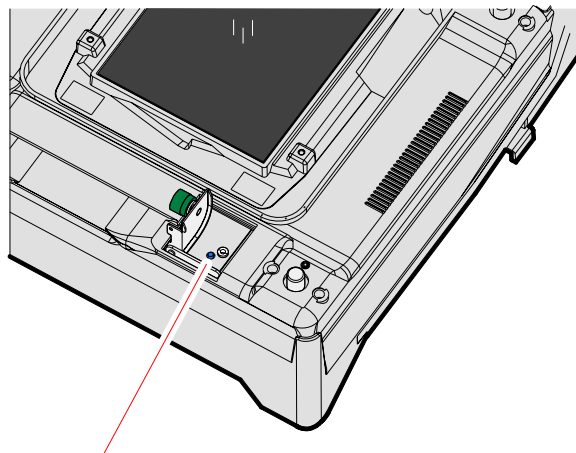

Scale Calibration Switch

25914

The unit will IMMEDIATELY begin a continuous clicking sound along with a steady tone.

**Note:** You MUST replace the Calibration Switch Cover and Top Plate, and complete the scale exercise procedure within 90 seconds. If not, the scanner will report a 'Calibration Error Code 8' and you will see 1 blue and 1 green LED on the Light Bar.

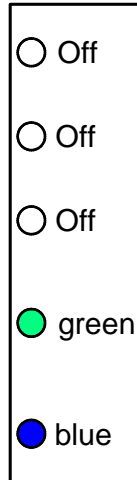

25688

**Note:** The unit prompts to perform the press-down procedure twice, otherwise the unit will report 'Calibration Error Code 8'.

c. PRESS DOWN PROCEDURE.

- i. Once the Top Plate is back on and all the LEDs in the tower Light Bar are off, use both hands and press down HARD on the Top Plate with a constant and increasing pressure.

**Note:** It will take a LOT of pressure. You might have to fully LEAN on the scale - you will not break it. The goal is to light ALL 5 LEDs and keep them on for 4 seconds.

- ii. As you press on the scale deck, an increasing number of LEDs will turn on indicating the amount of pressure you are applying.

Increasing pressure

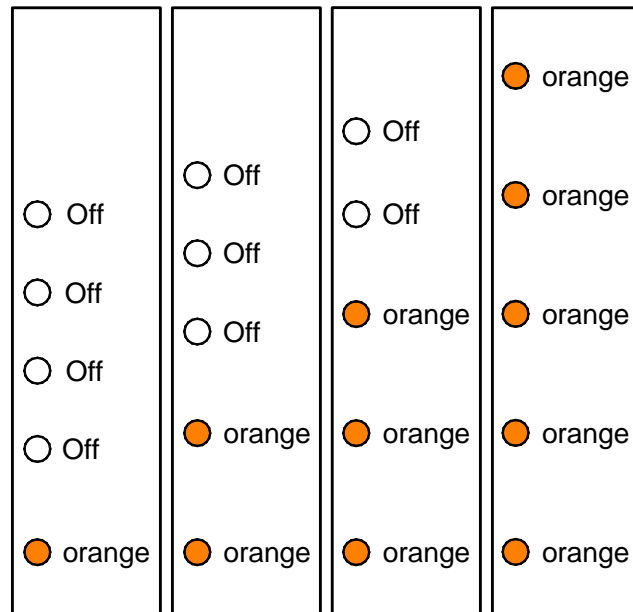

25689

- iii. As you press, the tone also increases in pitch, producing a different, higher tone for each additional LED that lights up. If you let go, the tone will decrease in pitch as the LEDs progressively turn off.

- iv. At the highest pitch, with ALL 5 LEDs on, you **MUST CONTINUE** pressing down with continuous consistent pressure until the 5 LEDs turn solid **red** and the scanner beeps four times.

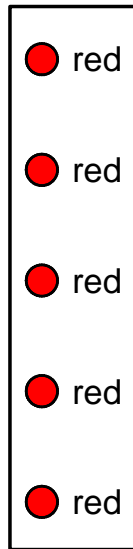

25795

- v. Finally, the scanner will say "Complete" and all the 5 LEDs will turn solid **blue**. You can then release your hands from the deck.

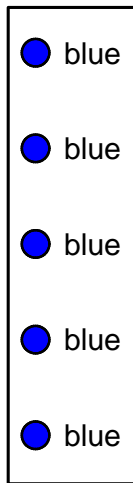

25796

- vi. Scanner will again say "**Press deck**".
- vii. Repeat the Press Down steps again until the scanner says "Complete".

4. Once the exercising is complete (press-down done twice), the scanner will require a delay before continuing with calibration. It will say "Please wait 20 seconds...15 seconds...10 seconds...five seconds...complete". There is a countdown shown on the 7825 remote display if one is attached.
5. The regular calibration procedure will begin after exercising is complete. Use the following procedures:

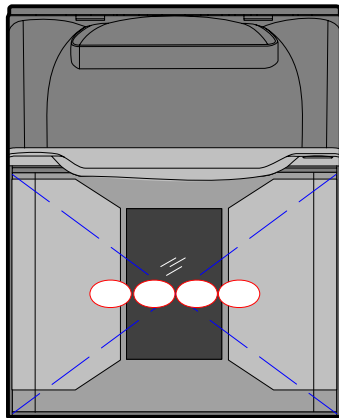

**Note:** Use the type of calibration procedure according to the type of weight sets being used.

**Note:** Place weights in circles shown when calibrating to ensure even distribution of weight during calibration. Start at the center and work outward horizontally with increasing weight. Do not scatter weights around the Top Plate

#### Calibration Using Kilogram Weights

- a. Scanner speaks "Place zero kilograms on deck then press Scale Zero". Make sure the scale has no weights on it (is empty) then press Scale Zero. Wait.
- b. Scanner speaks "Place 2.5 kilograms on deck then press Scale Zero". Put 2.5 kg on the scale then press Scale Zero. Wait.
- c. Scanner speaks "Place 7.5 kilograms on deck then press Scale Zero". Add 5.0 kg on the scale then press Scale Zero. Wait.
- d. Scanner speaks "Place 12.5 kilograms on deck then press Scale Zero". Add 5.0 kg on the scale then press Scale Zero. Wait.
- e. Scanner speaks "Place zero kilograms on deck then press Scale Zero". Take all the weights off the scale then press Scale Zero. Wait.
- f. Scanner speaks "Calibration complete" upon successful calibration.

#### Calibration Using Pound Weights

- a. Scanner speaks "Place zero pounds on deck then press Scale Zero". Make sure the scale has no weights on it (is empty) then press Scale Zero. Wait.
- b. Scanner speaks "Place 5 pounds on deck then press Scale Zero". Put 5 lb on the scale center then press Scale Zero. Wait.
- c. Scanner speaks "Place 15 pounds on deck then press Scale Zero". Add 10 more pounds to make 15 lb on the scale then press Scale Zero. Wait.

- d. Scanner speaks “Place 30 pounds on deck then press Scale Zero”. Add 15 more pounds to make 30 lb on the scale then press Scale Zero. Wait.
  - e. Scanner speaks “Place zero pounds on deck then press Scale Zero”. Take all the weights off the scale then press Scale Zero. Wait.
  - f. Scanner speaks “Calibration complete” upon successful calibration.
6. When successful calibration is concluded, take the Top Plate off, ensure the Scale Calibration Switch cover is closed, and tighten the green sealing screw.
  7. Seal the Calibration Switch Security Cover with one of the following seals:
    - Lead/Wire Seal (NCR Part Number: 603–8001097) using a Lead/Wire Seal Press (NCR Part Number: 603–9000157)
    - Film/Paper Seal (Obtain locally—Must meet the requirements of the local government)
- Note:** Depending on local laws, Weights and Measures officials may be required to attach the seal.
8. Reinstall the Top plate.

If Scan Doctor detects an error during the calibration procedure, one of the following error codes may be given.

Error Code	Problem	Suspect Components
1, 2, or 3	Possible out of range calibration error	Digital Board Scale Assembly
4	Scale hardware error	Digital Board Scale Assembly Scale Digital Cable
5	Scale Drift	Digital Board Scale Assembly Scale cables Power Supply
6	Failure to update parameters into EEPROM.	EEPROM Digital Board
7	Error reading parameters from EEPROM	EEPROM Digital Board
8	Scale exercising failed (not enough pressure or time consumed)	Top Plate is bottoming out
9	Linearity problem or slight vibration noted while calibrating Scale (Zero Drift)	Top Plate is touching checkstand. Scale was jarred.

After calibrating the scale, the accuracy must be verified to assure it meets the government requirements. This consists of a series of four tests that must be run in the continuous sequence given.

1. Increasing Load Test
2. Over-Capacity Test
3. Decreasing Load Test
4. Shift Test

### Increasing Load Test

This test checks the scale's accuracy when incrementally adding weight to the center of the Top Plate. Use weights that correspond to the 7874 weight features.

Step	Weight Feature	Add Weight	Remove Weight	Display Result
1	Kilogram	0.100 kg		$0.100 \pm 0.000$ kg
	Pound	0.20 lb		$0.20 \pm 0.00$ lb
2	Kilogram	2.500 kg	0.10 kg	$2.500 \pm 0.000$ kg
	Pound	5.00 lb	0.20 lb	$5.00 \pm 0.00$ lb
3	Kilogram	5.000 kg		$7.500 \pm 0.005$ kg
	Pound	5.00 lb		$10.00 \pm 0.01$ lb
4	Kilogram	5.000 kg		$12.500 \pm 0.005$ kg
	Pound	10.00 lb		$20.00 \pm 0.01$ lb
5	Kilogram	2.500 kg		$15.000 \pm 0.005$ kg
	Pound	10.00 lb		$30.00 \pm 0.01$ lb

24177

**Note:** Do **NOT** remove any weight from the Top Plate between test steps unless directed to do so.

### Over-Capacity Test

This test checks for the proper indication from the scale when too much weight is placed on the Top Plate.

**Note:** This test must immediately follow the Increasing Load Test; do not remove any of the weights from the previous test prior to running this test.

**Note:** Scale capacity is 30 lb or 15 kg in 0.01 lb or 0.005 kg increments.

Place additional weight on the center of the Top Plate as shown in the following table. Use the weight that corresponds to the 7874 weight feature. The display shows a series of dashes to indicate an over-capacity condition.

Step	Weight Feature	Add Weight	Remove Weight	Display Result
1	Kilogram	0.050 kg		--.---
	Pound	0.10 lb		--.---
2	Kilogram		0.050 kg	15.000 kg
	Pound		0.10 lb	30.00 lb

24180

**Note:** Do **NOT** remove any weight from the Top Plate after completing this test.

### Decreasing Load Test

This test checks the scale's accuracy when incrementally removing weight from the Top Plate. Use weights that correspond to the 7874 weight feature, as shown in the following table.

**Note:** This test must immediately follow the Over-Capacity Test; do **NOT** remove any of the weights from the previous test prior to running this test.

Step	Weight Feature	Remove Weight	Display Result
1	Kilogram	2.500 kg	10.000 ± 0.005 kg
	Pound	10.00 lb	20.00 ± 0.01 lb
2	Kilogram	5.000 kg	2.500 ± 0.000 kg
	Pound	10.00 lb	5.00 ± 0.00 lb
3	Kilogram	5.000 kg	0.100 ± 0.000 kg
	Pound	5.00 lb	0.20 ± 0.00 lb
4	Kilogram	2.500 kg	0.000 ± 0.000 kg
	Pound	5.00 lb	0.00 ± 0.00 lb

24179



## Shift Test

This test involves moving a weight off the center point of the Top Plate to check for continued accuracy.

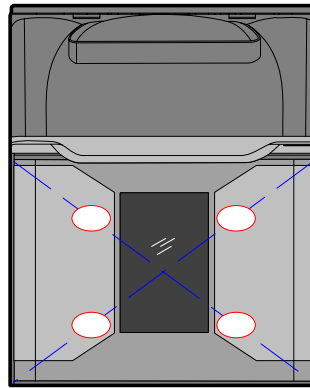

Test Pattern

25344

1. Place an appropriate Test Load weight for each weight feature on each of the four circles individually. The display must show the same weight between any of the 4 readings.

**Note:** Each circle is half-way between the center of the Top Plate and the corner.

2. Remove all weights. The display must read  $0.000 \pm 0.005$  kg ( $0.00 \pm 0.01$  lb). Test max thirty pounds (30.00 lb) in center only.
3. Press and hold the **Scale Zero** button. Record the Cal and Par values shown on the display.

Position	Weight Feature	Test Load	Display Result
1	Kilogram	5.000 kg	5.000 kg
	Pound	10.00 lb	10.00 lb
2	Kilogram	5.000 kg	5.000 kg
	Pound	10.00 lb	10.00 lb
3	Kilogram	5.000 kg	5.000 kg
	Pound	10.00 lb	10.00 lb
4	Kilogram	5.000 kg	5.000 kg
	Pound	10.00 lb	10.00 lb
5	Kilogram	5.000 kg	5.000 kg
	Pound	10.00 lb	10.00 lb

24178

**Note:** Circles are half way from the center and corners of the Top Plate.

### Securing the Calibration Switch

After performing a scale calibration, attach a seal to the scale calibration security cover. Depending on the local laws, Weights and Measures officials may be required to attach the seal.

**Note:** In the United States and Canada, the audit trail serves as an acceptable security seal when the RealScan 25 Compact Display is present.

Perform the following procedure to secure the calibration switch.

1. Remove the Top Plate.
2. Remove the clear plastic Calibration Switch Cover located on the right-front corner of the unit. Lift the left side of the cover to unlatch and remove it.

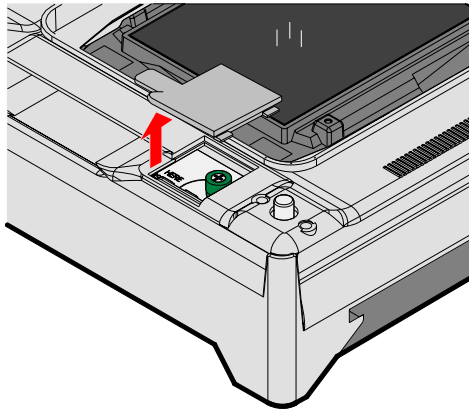

25918

3. Move the Calibration Switch Security Cover until the screw holes and the seal holes are properly aligned and fasten the green thumbscrew in the Calibration Switch Security Cover to secure the Calibration Switch.

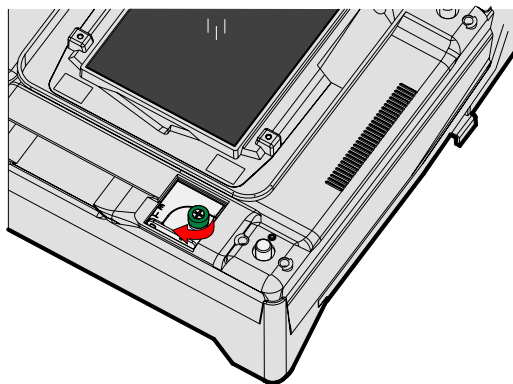

25916

4. Seal the Calibration Switch Security Cover with one of the following seals:
  - Lead/Wire Seal (NCR Part Number: 603-8001097) using a Lead/Wire Seal Press (NCR Part Number: 603-9000157)
  - Film/Paper Seal (Obtain locally – Must meet the requirements of the local government)
5. Install the Calibration Switch Cover.

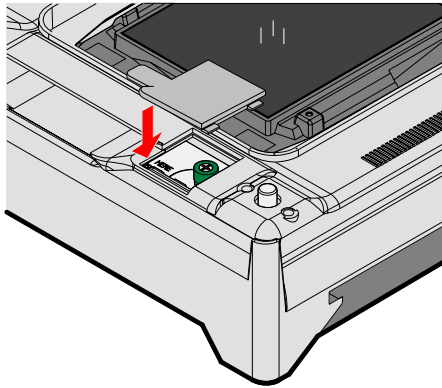

25979

6. Turn the scanner over and install the four leveling screws.

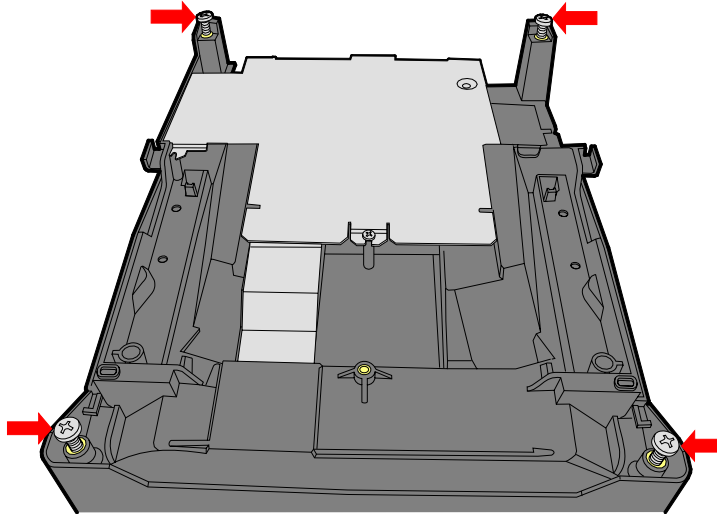

25987

7. Turn the scanner back to its upright position and install the Top Plate.

## Step 8: Sensormatic® Deactivation Setup

### Sensormatic Tag Deactivation

Connect the Sensormatic® Tag Deactivation System to the RS232 auxiliary port, which is Port 2. If a hand-held scanner is used, connect the hand-held to Port 1. When the 7874 scanner reads a tag, the Sensormatic® hardware needs to receive an interlock signal for it to function. When the system is installed, the Sensormatic® Interlock Signal must be enabled.

There are two modes of Sensormatic operation, Interlocked and Non-interlocked. The mode is controlled by the Scan Enable Time which is a setting in the Sensormatic controller. When the Scan Enable Time is set to a value between 1 and 29, the system will run in the Interlock Mode. If the value is 0 or 30 the system will run in the Non-interlock Mode.

#### *Interlock Mode*

The scanner reads the Scan Enable Time from the controller. If it is between 1 to 29, it will enable the controller for deactivation for this many seconds after a bar code is read and then will disable the controller until the next bar code. Interlock mode is used in self service lanes and cashier assisted lanes.

#### *Non-Interlock Mode*

If the Scan Enable value is 0 or 30, the scanner will enable the Sensormatic controller for deactivation any time the scanner is enabled to read tags. In most systems, this corresponds to the time the cashier is signed into the host terminal. The host terminal sends an “enable” to the scanner at cashier sign in and this is passed on to the Sensormatic controller. At cashier sign out, the host terminal sends a “disable” to the scanner and the Sensormatic controller is disabled. This is called Non-interlock Mode. This mode is designed for the cashier lanes.

### Sensormatic® Online Offline Indication

If the scanner is programmed for Sensormatic operation when the scanner powers up and it establishes communication with the Sensormatic controller, it will speak the message “EAS Online”. This may take from 5 to 10 seconds. If this is the first time the Sensormatic controller has been detected, the scanner will remember that it has seen a controller and from then on at startup, if the controller is not detected, the scanner will speak “EAS offline”. Once operation has started and the communication to the controller is lost, the scanner will speak “EAS Offline”. If the communication is reestablished, the scanner will speak “EAS online”. The only time the “EAS Offline” message is not spoken is on a new unit which has never been connected to a Sensormatic controller. This is to limit the messages at installation and testing before the controllers are installed.

### *Cashier Sign In Offline Alert*

There is a feature to alert the cashier of the EAS system state at sign in. When the sign in occurs and the scanner is enabled if the EAS system is offline the “EAS Offline message will be spoken”. There is a programmable time limit on how long the sign out period must be before the offline message is spoken in order to prevent extraneous messages when cashier must sign in and out frequently. This message is from 1 to 15 minutes and is selected with the following programming tag sequence.

1. **Program Mode**—puts the scanner in programming mode.
2. **Hex 7, Hex C, Hex x**—where x is the time in minutes (1 to 15).
3. **Save and Reset**—saves the enabled setting and resets the 7874.

### *EAS Status LED*

There is an LED indicator beside the Manual Deactivation Button used to indicate the EAS system status. The LED will be on solid when the system is connected and operating properly. If the system is connected but not communicating the LED will be flashing. The LED is off when the EAS feature is disabled.

### *Enable Sensormatic® Communications*

Scan the following sequence of programming tags to enable the Sensormatic® communications. These must be the first tags scanned after applying power to the 7874.

1. **Program Mode**—puts the scanner in programming mode.
2. **Hex 4, Hex 2, Hex B**—enables Sensormatic® Interlock Signal.
3. **Save and Reset**—saves the enabled setting and resets the 7874.

### *Disable Sensormatic® Communications*

Scan the following sequence of programming tags to disable the Sensormatic® communications. These must be the first tags scanned after applying power to the 7874.

1. **Program Mode**—puts scanner in programming mode.
2. **Hex 4, Hex 2, Hex A**—disables Sensormatic® Interlock Signal.
3. **Save and Reset**—stores the disabled setting and resets the 7874.

### *Sensormatic® Deactivation Tones*

The deactivation tone is heard after the Sensormatic controller senses a EAS tag and fires the deactivator. The tone is a series of pulses programmable in frequency and number of pulses. There can be 1 to 8 pulses of a single frequency or 1 to 7 pulses of dual tones.

Scan the following sequence of programming tags to change the tone frequency of the 7874.

1. **Program Mode**—puts scanner in programming mode.
2. **Hex 5, Hex 8, Hex B**—increments to the next frequencies. Continue scanning **Hex B** to get the desired frequency. There are eight frequencies to choose from:
  - 570 Hz (default)
  - 637 Hz
  - 721 Hz
  - 829 Hz
  - 976 Hz
  - 1186 Hz
  - 1512 Hz
  - 2083 Hz
3. **End**—completes the programming sequence.
4. **Save and Reset**—stores the setting and resets the 7874.

#### *Sensormatic® Deactivation Tone Pulse Length*

Scan the following sequence of programming tags to change the number of pulses in the deactivation tone of the 7874.

1. **Program Mode**—puts scanner in programming mode.
2. **Hex 7, Hex B, Hex x**—where x is the number of desired pulses. With 1-8 pulses there is a single frequency tone. With 9-15 pulses there are 1 to 7 pulses of dual tone frequency
3. **Save and Reset**—stores the setting and resets the 7874.

### Specific Function Programming

There are several Sensormatic® Security Tag Deactivation functions that can be programmed at the 7874.

#### *Manual Deactivation*

The Manual Deactivation function permits the user to disable scanning and enable Sensormatic® Security Tag Deactivation for 3 seconds with each touch of the Manual Deactivation button on the 7874 Operator Display Panel. A bar code can also be sent through the host terminal to report the manual deactivation. The bar code is sent after the button is pressed and the deactivation signal is received from the controller.

The Manual Deactivation function is enabled and disabled by scanning the following Manual Deactivation Function Tag.



**012345000143**

Scanning this tag is a toggle function. The number of beeps indicates how the function is set.

- 1 Beep—Manual Deactivation function is disabled
- 2 Beeps—Manual Deactivation function is enabled—Factory Default
- 3 Beeps—Function is enabled plus 04858999977 bar code sent

After enabling or disabling the Manual Deactivation function, scan the following Reset tag to make the setting permanent in the 7874.

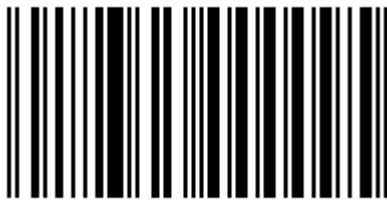

**012345000095**

#### *Bar Code Label Hold-Off*

The purpose of the Bar Code Label Hold-Off function is to force the user to bring the bar code closer to the scanner when a live EAS tag is present on the item being scanned. When the 7874 detects a live EAS tag it emits a clicking sound and sets a ½-second timer (optional). The timer will be restarted and will not expire as long as the EAS tag is detected. During this time the 7874 does not beep or send bar code data to the host terminal even though it may read the bar code. The timer will not be restarted once the EAS tag is deactivated. After the timer expires, the 7874 beeps and sends bar code data to the host terminal. If the bar code has been removed from the scan field, it may have to be returned to the field to be read and sent to the host terminal.

The Bar Code Label Hold-Off function is enabled and disabled by scanning the Bar Code Label Hold-Off tag.



**012345000115**

Scanning this tag is a toggle function. The number of beeps indicates how the function is set.

- 1 Beep—Bar Code Label Hold-Off function is disabled

- 2 Beeps—Bar Code Label Hold-Off function is enabled—Factory Default

After enabling or disabling the Bar Code Label Hold-Off function, scan the following Reset tag to make the setting permanent in the 7874.

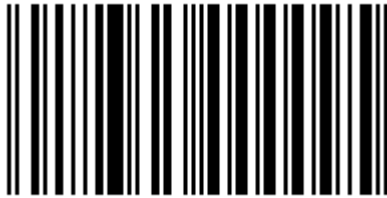

012345000095

#### *Audible Detection*

The Audible Detection function provides direct feedback to the user when a live EAS tag is in the field of view of the scanner. Clicks are enabled on the scanner.

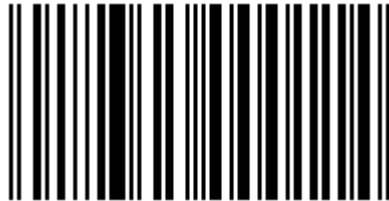

012345000114

The Audible Detection (click) function toggles between 1, 2, and 3 beeps with each scan.

- 1 Beep—Audible Detection function is disabled
- 2 Beeps—Audible Detection function is enabled
- 3 Beeps—Audible Detection function is enabled plus deactivation tone

#### *EAS Optional Communications*

The EAS Optional Communications function alerts the host terminal software with a bar code communication message in three ways. This permits the host terminal to control the sequence of events at the scanner.

- The 7874 sends the Error bar code (048589999999) if an EAS detection signal occurs after a bar code is read by the scanner (for example, the Sensormatic® tag is still live). The Error Bar Code Timer defines the window for permitting a deactivation to occur after a bar code is read. The timer can be set from ½ second to 4 seconds in ½-second increments. If the timer expires and no EAS deactivation has occurred, the Error bar code is sent to the host terminal software.
- The 7874 can send a Detect bar code (048589999988) every 4 seconds when EAS detections are occurring (a live EAS tag is in the detection field).
- The 7874 can send both bar codes if both conditions are met.



Scan the following EAS Communications Function tag to set the EAS Communication function.



**012345000134**

The function changes each time this tag is scanned. The number of beeps indicates how the function is set.

- 1 Beep—EAS Communications function is disabled—Factory default
- 2 Beeps—7874 sends Error bar code (04858999999)
- 3 Beeps—7874 sends Error bar code (04858999999) and Detect bar code (04858999988)
- 4 Beeps—7874 sends Detect bar code (04858999988)

The following tag increments the Error bar code timer. Each time the tag is read, the time is incremented  $\frac{1}{2}$  second until the maximum time is reached. It then starts over with the least time.



**012345000116**

The number of beeps indicates how the timer is set.

- 1 Beep— $\frac{1}{2}$  second
- 2 Beeps—1 second
- 3 Beeps— $1\frac{1}{2}$  seconds
- 4 Beeps—2 seconds
- 5 Beeps— $2\frac{1}{2}$  seconds
- 6 Beeps—3 seconds
- 7 Beeps— $3\frac{1}{2}$  seconds
- 8 Beeps—4 seconds

After setting the EAS Optional Communication function and the Error Bar code timer, scan the following Reset tag to make the setting permanent in the 7874.

#### Reset Bar Code

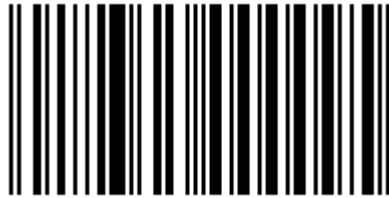

012345000095

#### *Error, Detect, and Manual Deactivation Bar Codes*

The following are the Error, Detect, and Manual Deactivation bar codes, respectively. These bar codes are used for testing the host terminal system. Scan the bar code to simulate the effect on the host terminal system.

- Error Bar Code



048589999999

- Detect Bar Code



048589999988

- Manual Deactivation Bar Code



0 48589 99997 7

#### Power-up the System

**Note:** Refer to the Sensormatic® AMB9010 Controller documentation for additional information about setting up the controller.

Perform the following procedure to power-up the system.

1. Turn on the 7874. When the 7874 is first turned on, all Sensormatic® parameters should be at their default settings:

- 7874 Deactivation Button = Enabled
  - 7874 Detection Clicking = Enabled
2. Turn on the Sensormatic® AMB9010 Controller. This system is programmed at the factory with default settings for proper operation.
  3. After the 7874 and the Sensormatic® AMB9010 Controller are operating for about 15 seconds, the 7874 gives the voice message **EAS Online**.

**Note:** Voice message **EAS Online** must be given before continuing. If voice message **EAS Online** is not given, turn off the power to all components. Check all cable connections and then repeat this procedure starting at Step 1. If voice message **EAS Online** is still not given and the Manual Deactivation Button flashes, scan the **Reset** programming tag. If **EAS Online** status is still not given, follow instructions on the Sensormatic Card—*Before You Call About....* The problem may be a bad Antenna cable.

4. Position a **Hard** Tag over the top of the 7874. As the **Hard** Tag is moved, the 7874 starts clicking when the tag moves within four inches of the center of the Top Plate. If the clicking sound is not generated, scan the Reset programming tag, then go to Step 3. If the second attempt fails, call for technical assistance. Refer to Appendix D for NCR Technical Support contact information.

## Check Sensormatic® Deactivation System

### *Check the System*

Position a **Hard** tag above the 7874 Top Plate. As the tag moves within four inches of the Top Plate, a clicking sound is heard (if programmed). Refer to the previous topic, “Audible Detection,” for instructions on enabling the clicking sound. If the **Hard** tag has to be closer than four inches to from the Top Plate to get the clicks, consult the Sensormatic® Card—*Before You Call About....*

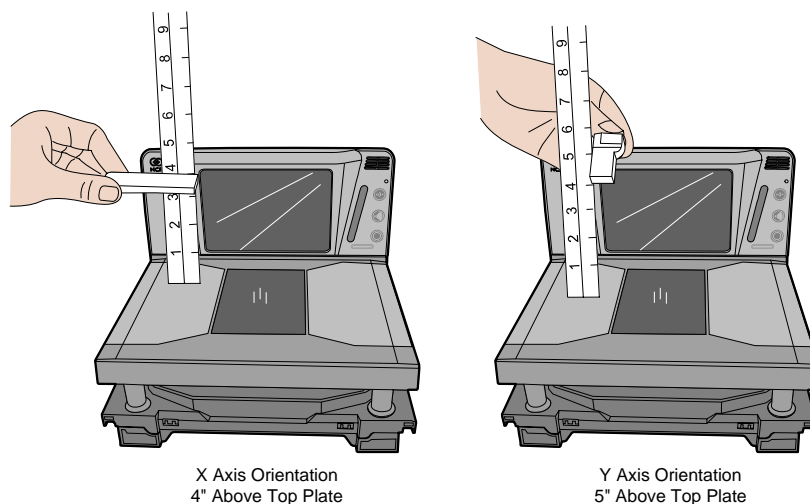

Next, obtain a security tag that has not been deactivated. Scan a bar code and immediately pass the security tag through the deactivation zone. The Good Read Tone should sound indicating a good read of the bar code and deactivation of the security tag. Refer to the “Sensormatic Tag Deactivation Procedure” section in chapter 4 for detailed operating instructions.

*Call Sensormatic®*

After the NCR 7874 Sensormatic® configuration is installed, call Sensormatic® to have them test, tune, and phase their system.

## Step 9: Operational Unit Verification

When power is applied to the 7874, the Scan Doctor software checks many of the scanner components.

### NCR 7874 Scanner-Only Models

After passing the Scan Doctor Power-On Wellness Check, the Scan Adviser will start out with five blue LEDs and transitions through a range of colors, and leaves only the three center LEDs lit in green. The 7874 is now operational.

### NCR 7874 Scanner/Scale Models

After passing the Scan Doctor Power-On Wellness Check, the 7874 runs scale diagnostics. During this time, all segments on the RealScan 25 Remote Display are turned ON so the operator can verify the display works correctly. Then the display reads 0.000 kg (0.00 lb). The Light Bar starts out momentarily with five blue LEDs, changes to five red LEDs and blinks them five times. The unit beeps once after that and the 7874 is now operational.

## 7874 Power-On Wellness Check

If an error occurs during the Power-On Wellness Check, the RealScan 25 Remote Display (if the unit has one) displays an error code, and if enabled, the 7874 emits an audible description of the error and what action to take. There may be some simple steps that can be performed to correct the problem (refer to chapter 6 for more information). If the problem cannot be corrected, contact the maintenance provider for warranty and service information.

### Checkout Reading Operation

The 7874 comes from the factory with the programming parameters set to default values. The Communications Protocol is set to the specifications on the order. However, some parameter changes for a particular installation can be made. Refer to chapter 5 for more information.

## Flash Latest Firmware

The 7874 includes firmware flashing. This permits upgrades to the firmware without replacing the actual firmware chip. It is possible to flash the scanner completely unattended from the host terminal using the NCR RealPOS Scanner Tool Suite (sold separately).

**Note:** There is a set of instructions for loading the appropriate Scanner Tool Suite based on the firmware currently in the scanner. Refer to the “Firmware Flashing” section in Chapter 5 for more detailed information.

## Special Host Terminal Connections

### Scanner Connected to IBM Terminals

The scanner and scanner interface to any IBM host terminal system is basically Plug-and-Play, assuming the scanner unit is programmed for IBM Communications (Refer to the “Programming Worksheets” section on Chapter 5 for more information). These systems are always single-cable, that is, one cable carries traffic for the scanner. There are no configurable parameters in the IBM interface—the protocol is standardized and without any flexibility as far as bar code data formatting or interface characteristics such as baud rate.

The host terminal port into which the scanner unit is plugged varies with the type of host terminal.

The older 468x series of host terminals require the scanner unit to be plugged into port 17.

Newer IBM host terminals no longer have this port; instead they use cable 1416-C070-0040 to plug into port 9x (the “x” varies depending on the host terminal model).

### SNI Beetle Host Terminal

For the 7874 to communicate with an SNI Beetle Host Terminal, the communication parameters must be properly set. Scanning the following sequence of programming tags enables a typical installation; however, some variations may be necessary for any specific installation.

The following programming tags must be the first ones scanned after applying power to the 7874.

1. **Program Mode**—enables programming mode
2. **Hex 3, Hex 4, Hex F, Hex 0, Hex 0**—chooses Wincor-Nixdorf Beetle parameters
3. **Save and Reset**—save Beetle parameters
4. **Default**—permanently store Beetle parameters as the default settings

The following settings get changed:

*RS232 Communication*

*9600 Baud, 8-bit, Odd Parity, 1 Stop, Raise RTS – Wait for CTS*

*Scanner Only Protocol*

*Terminator = 0Dh*

*One Tag Output Buffer enabled (buffers only one tag)*

Label Identifiers	
EAN13	= "A" (41h)
EAN8	= "B" (42h)
UPC-E	= "C" (43h)
UPC-A	= "A0" (41h 30h) (UPC-A is expanded into EAN13)
Code 39	= "M" (4Dh)
I 2 of 5	= "I" (49h)
Code 128	= "K" (4Bh)
UCC/EAN128	= "P" (50h) (UCC/EAN128 Label ID is enabled)
Codabar	= "N" (4Eh)
Pharmacode	= "A" (41h)

25592

## Peripheral Connections

Please be aware that these Hand-Held setup instructions assume Code 128, Code 39 and Interleaved 2 of 5 are enabled on the 7874. Otherwise, if any of those bar code types are scanned with any of the Hand-Helds, and they are not also enabled on the 7874, then the 7874 produces a "bad" tone and will NOT transmit the barcode data.

### Metrologic Hand-Held Scanner

A Metrologic Hand-Held Scanner can be connected to one of the RS232 auxiliary ports on the NCR 7874. If the Metrologic Hand-Held is the only peripheral device, it can be connected to either port. However, if connecting another peripheral device, there may be restrictions for the Metrologic port connection.

**Note:** These were recently tested on a Metrologic Voyager (Metrologic MS9540) and worked. However, each additional model needs to be verified.

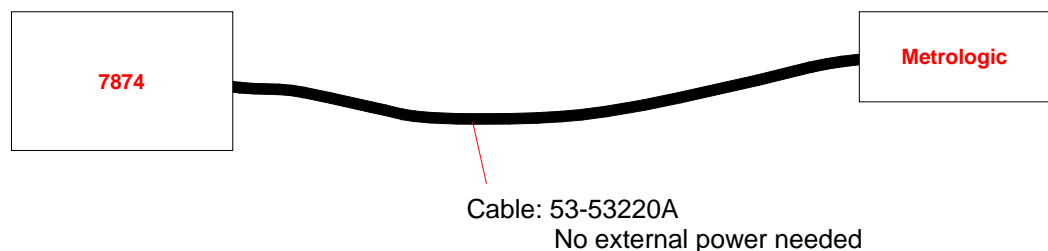

25789

### Programming the Metrologic Hand-Held Scanner if Connected through the Auxiliary RS232 Port

Scan the following sequence of tags with the Metrologic Hand-Held Scanner. If the scanner encounters problems reading these tags, use the tags printed in the Metrologic Installation and User's Guide:

<http://www.metrologic.com/corporate/products/pos/ms9520/>

Enter Config Mode

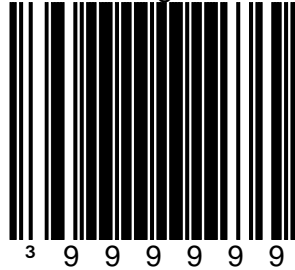

Recall Defaults

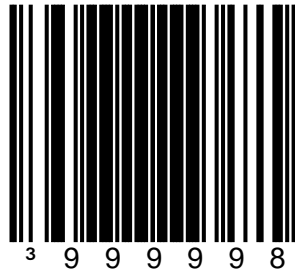

Enable RS232

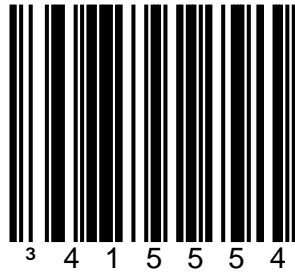

1 stop bit

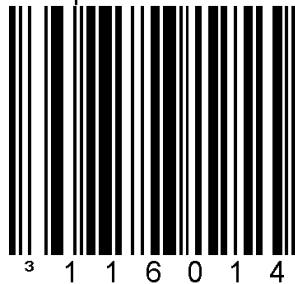



Even Parity

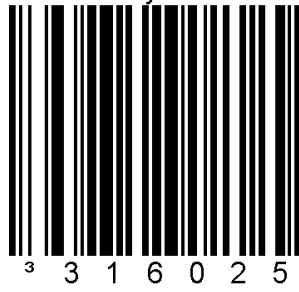

UPC Prefix Id

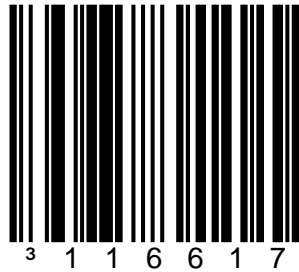

9600 Baud

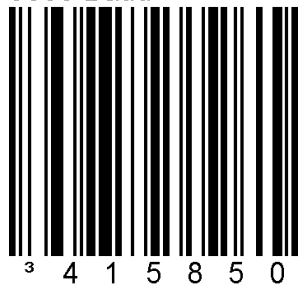

CR-LF on

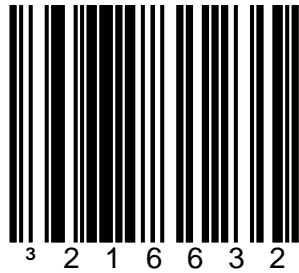

UPC Format



Transmit UPC-E check

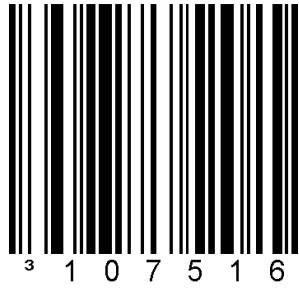

ITF "b"



Code 39 "a"

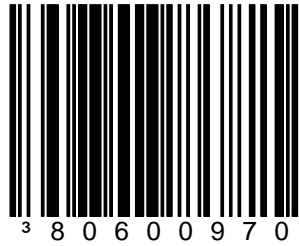

Code 128 "f"

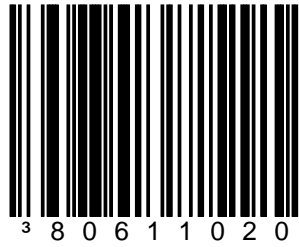

Exit Config Mode

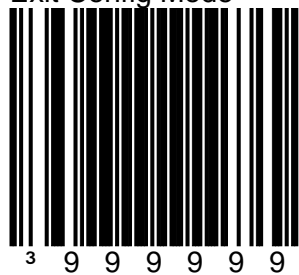

## Programming the 7874

When installing a Metrologic Hand-Held Scanner, certain programming options must be set in the 7874. Program these options as follows.

There are four options that must be programmed on the 7874. Scan the following tags to set these options. These must be the first tags scanned after applying power to the 7874.

### *Hand-Held Processing*

Selection	Programming Tag Sequence	Setting
Enable	Programming Mode, Hex 4, Hex 0, Hex 1, Save and Reset	Required
Disable	Programming Mode, Hex 4, Hex 0, Hex 0, Save and Reset	

16386A

### *Hand-Held Port Selection*

Selection	Programming Tag Sequence	Setting
Port 1	Programming Mode, Hex 4, Hex 0, Hex 2, Save and Reset	Either
Port 2	Programming Mode, Hex 4, Hex 0, Hex 3, Save and Reset	Either

24857

### *Hand-Held Beep on 7874*

Selection	Programming Tag Sequence	Setting
Enable	Programming Mode, Hex 4, Hex 0, Hex 5, Save and Reset	Required
Disable	Programming Mode, Hex 4, Hex 0, Hex 4, Save and Reset	

16386D

### *Hand-Held Selection*

Selection	Programming Tag Sequence	Setting
Enable	Programming Mode, Hex 5, Hex 5, Hex 1, Save and Reset	Required

24855

## NCR 2357 and Hand-Held Products (Honeywell) Type Hand-Held Scanner

These instructions apply to all Hand-Held Products scanners and 7837 models (except the 7837-1000 specifically), including the 3800g and 4600 series imagers.

When connecting a 2357 Hand-Held Scanner, certain programming options must be set on both the 7874 and the Handheld Scanner. These options are given as follows.

### Programming Hand-Held Products Scanner if Connected through the Auxiliary RS232 Port

If the 2357 Hand-Held Scanner (any model) is connected to the 7874 through the auxiliary RS232 port, program the Hand-Held Products Scanner by scanning the following bar codes in order. If a triple beep is emitted from the Hand-Held scanner, start over with the first bar code.

FACTORY DEFAULT

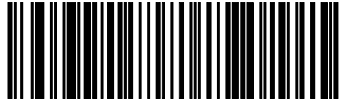

7837-1300 RS232 9600, 7, even, 1



Prefixes / Code 39 - a, Code 128 - f, Code I 2of 5 - b



Default Data Format



7837-1300 UPC-A Prefix A



7837-1300 UPC-E Prefix E



7837-1300 EAN-13 Prefix F



7837-1300 EAN-8 Prefix FF



Matrix RTS/CTS Mode 3 Enable



## Programming the 7874

There are four options that must be programmed on the 7874. Scan the following programming tags to set these options. These must be the first tags scanned after applying power to the 7874.

### *Hand-Held Processing*

Selection	Programming Tag Sequence	Setting
Enable	Programming Mode, Hex 4, Hex 0, Hex 1, Save and Reset	Required
Disable	Programming Mode, Hex 4, Hex 0, Hex 0, Save and Reset	

16386A

### *Hand-Held Port Selection*

Selection	Programming Tag Sequence	Setting
Port 1	Programming Mode, Hex 4, Hex 0, Hex 2, Save and Reset	Either
Port 2	Programming Mode, Hex 4, Hex 0, Hex 3, Save and Reset	Either

24857

### *Hand-Held Beep on 7874*

Selection	Programming Tag Sequence	Setting
Enable	Programming Mode, Hex 4, Hex 0, Hex 5, Save and Reset	Either
Disable	Programming Mode, Hex 4, Hex 0, Hex 4, Save and Reset	Either

16386F

### *Hand-Held Selection*

Selection	Programming Tag Sequence	Setting
Enable	Programming Mode, Hex 5, Hex 5, Hex 1, Save and Reset	Required

24855

## Programming NCR 2357 Hand-Held Scanner if Connected through the USB Peripheral Port

### *Prerequisites:*

### *Firmware Levels:*

- 7874, 497-0461146 - USB HH (pdf417 support not available)

### *Programming:*

Use the following programming sequence if you want to make the scanner beep whenever it receives a valid barcode data through the USB host port (the scanner does not beep by default):

Selection	Programming Tag Sequence	Setting
Enable	Programming Mode, Hex 4, Hex 0, Hex 5, Save and Reset	Required
Disable	Programming Mode, Hex 4, Hex 0, Hex 4, Save and Reset	

16386D

If the 2357 Hand-Held Scanner (any model) is connected to the 7874 through the USB peripheral port, program 2357 Hand-Held Scanner by scanning the following bar codes in order.

There is NO programming necessary on the 7874 for this connection.

### Factory Default

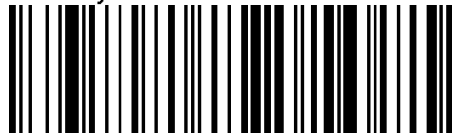

### IBM Hand-Held USB



If it is desired to scan PDF 417 (2D) bar codes with the Hand-Held, you can enable the 7874 to allow the pass-through of the data without the 7874 itself having the capability to read that type of bar code.

The following programming sequence is only for USB-configured Hand-Helds:

Selection	Programming Tag Sequence	Setting
Enable	Programming Mode, Hex 7, Hex F, Hex 9, Save and Reset	
Disable	Programming Mode, Hex 7, Hex F, Hex 8, Save and Reset	Default

27023

## NCR 2356 and Symbol (Motorola) Type Hand-Held Scanner

A NCR 2356 Hand-Held Scanner can be connected to one of the auxiliary RS232 ports on the NCR 7874. If the 2356-4208 is the only peripheral device, it can be connected to either port. However, if connecting another peripheral device, like Sensormatic® for example, there may be restrictions for the 2356 port connection.

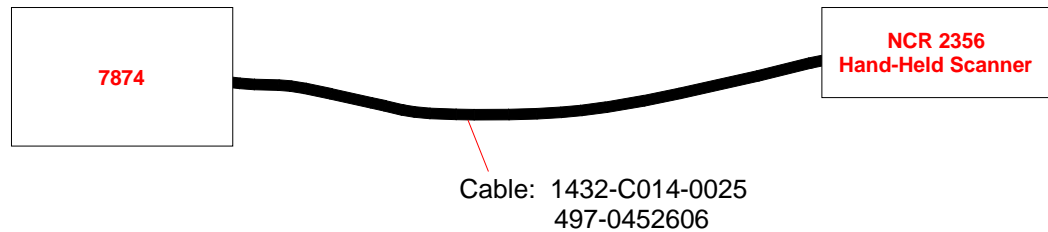

25790

### Programming the NCR 2356 Hand-Held if Connected through the Auxiliary RS232 Port

For any 2356 connected to the 7874 through the RS232 port, program the Hand-Held Scanner by scanning the following bar codes in order. If the scanner encounters problems reading these tags, use the individual bar codes printed in the appropriate NCR 2356 User's Guide.

If you start at the external server, <http://www.info.ncr.com/> select **General Search** under Point of Sale then select **Retail-Scanners** in the Product Line pull-down menu on the top, then select the **SEARCH** button.

#### ICL RS-232

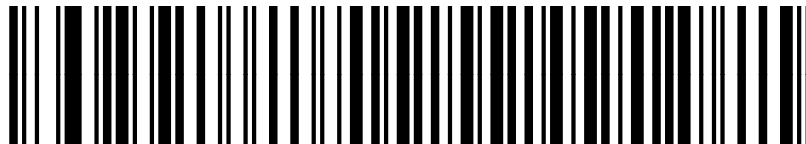

#### Even Parity



#### 7-bit data

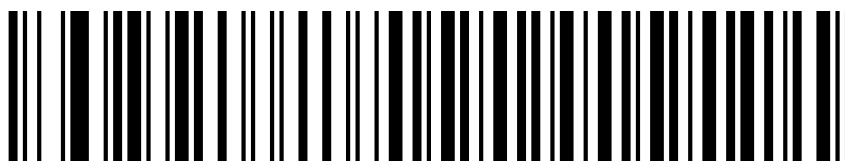

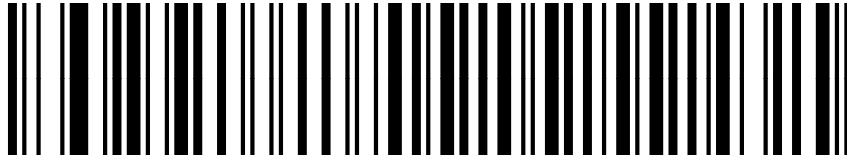
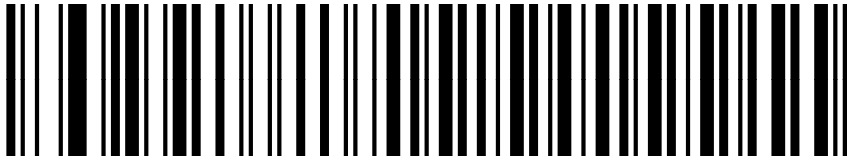
*RTS/CTS Option 2**Host: Low RTS**Auto-discriminate Supplementals***Programming the 7874**

There are four options that must be programmed on the 7874. Scan the following programming tags to set these options. These must be the first tags scanned after applying power to the 7874.

*Hand-Held Processing*

Selection	Programming Tag Sequence	Setting
Enable	Programming Mode, Hex 4, Hex 0, Hex 1, Save and Reset	Required
Disable	Programming Mode, Hex 4, Hex 0, Hex 0, Save and Reset	

16386A

*Hand-Held Port Selection*

Selection	Programming Tag Sequence	Setting
Port 1	Programming Mode, Hex 4, Hex 0, Hex 2, Save and Reset	Either
Port 2	Programming Mode, Hex 4, Hex 0, Hex 3, Save and Reset	Either

24857

*Hand-Held Beep on 7874*

Selection	Programming Tag Sequence	Setting
Enable	Programming Mode, Hex 4, Hex 0, Hex 5, Save and Reset	Either
Disable	Programming Mode, Hex 4, Hex 0, Hex 4, Save and Reset	Either

16386F

*Hand-Held Selection*

Selection	Programming Tag Sequence	Setting
Enable	Programming Mode, Hex 5, Hex 5, Hex 2, Save and Reset	Required

24856



## Programming NCR 2356 Hand-Held Scanner if Connected through the USB Peripheral Port

### *Prerequisites:*

### *Firmware Levels:*

- 7874, 497-0461146 - USB HH (pdf417 support not available)

### *Programming:*

Use the following programming sequence if you want to make the scanner beep whenever it receives a valid barcode data through the USB host port (the scanner does not beep by default):

Selection	Programming Tag Sequence	Setting
Enable	Programming Mode, Hex 4, Hex 0, Hex 5, Save and Reset	Required
Disable	Programming Mode, Hex 4, Hex 0, Hex 4, Save and Reset	

16386D

If the 2356 Hand-Held Scanner (any model) is connected to the 7874 through the USB peripheral port, program the 2356 by scanning the following bar codes in order. If a triple beep is emitted from the Symbol scanner, start over with the first bar code.



## Set Factory Defaults



## IBM Hand-Held USB

If it is desired to scan PDF 417 (2D) bar codes with the Hand-Held, you can enable the 7874 to allow the pass-through of the data without the 7874 itself having the capability to read that type of bar code.

The following programming sequence is only for USB-configured Hand-Helds:

<b>Selection</b>	<b>Programming Tag Sequence</b>	<b>Setting</b>
Enable	Programming Mode, Hex 7, Hex F, Hex 9, Save and Reset	
Disable	Programming Mode, Hex 7, Hex F, Hex 8, Save and Reset	Default

27023

## NCR 2356-4278 Wireless Hand-Held Scanner

A NCR 2356 Wireless Hand-Held Scanner can be connected to one of the auxiliary RS232 ports on the NCR 7874. If the 2356 Wireless Hand-Held Scanner is the only peripheral device, it can be connected to either port. However, if connecting another peripheral device, like Sensormatic® for example, there may be restrictions for the port connection.

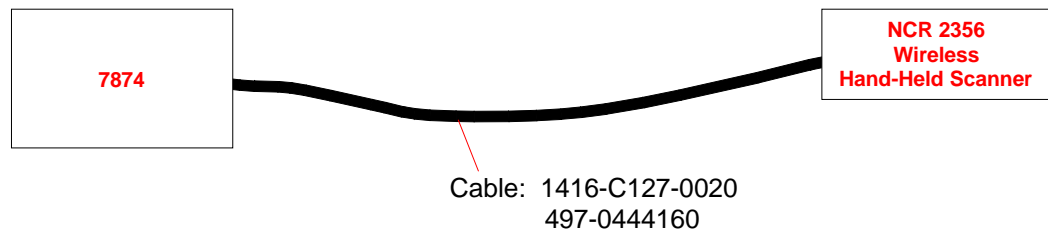

25791

### Programming the NCR 2356 Wireless Hand-Held Scanner

Scan the following sequence of tags with the 2356 Wireless Hand-Held Scanner. If the scanner encounters problems reading the tags, use the tags printed in the Symbol Technologies documentation.

#### *Set All Defaults*



#### *ICL RS232*

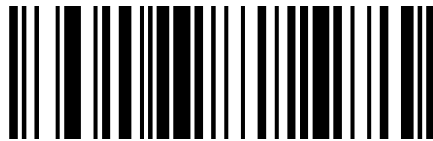

#### *7-bit Data*

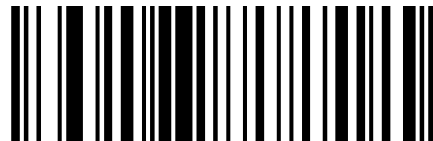

#### *1 Stop Bit*

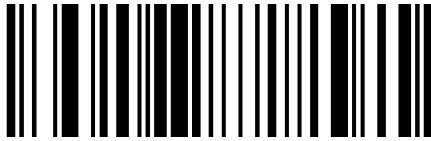
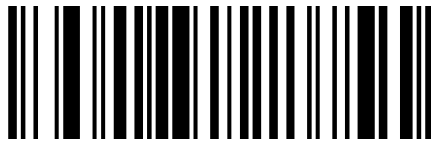

*Even Parity**RTS/CTS Option 2**Host: Low RTS*

After scanning the last tag, remove power from the 2356 Wireless Hand-Held Scanner by unplugging the cable, then plugging it back in.

**Programming the 7874**

There are four options that must be programmed on the 7874. Scan the following programming tags to set these options. These must be the first tags scanned after applying power to the 7874.

*Hand-Held Processing*

Selection	Programming Tag Sequence	Setting
Enable	Programming Mode, Hex 4, Hex 0, Hex 1, Save and Reset	Required
Disable	Programming Mode, Hex 4, Hex 0, Hex 0, Save and Reset	

16386A

*Hand-Held Port Selection*

Selection	Programming Tag Sequence	Setting
Port 1	Programming Mode, Hex 4, Hex 0, Hex 2, Save and Reset	Either
Port 2	Programming Mode, Hex 4, Hex 0, Hex 3, Save and Reset	Either

24857

*Hand-Held Beep on 7874*

Selection	Programming Tag Sequence	Setting
Enable	Programming Mode, Hex 4, Hex 0, Hex 5, Save and Reset	Required
Disable	Programming Mode, Hex 4, Hex 0, Hex 4, Save and Reset	

16386D

*Hand-Held Selection*

Selection	Programming Tag Sequence	Setting
Enable	Programming Mode, Hex 5, Hex 5, Hex 2, Save and Reset	Required

24856

## *Chapter 4: Operation*

---

The NCR 7874 requires very little attention during operation. It is designed to reduce the amount of bar code orientation prior to scanning an item. Most people become proficient in a very short time because of the bi-optic design and the PACESETTER functionality.

# System Components

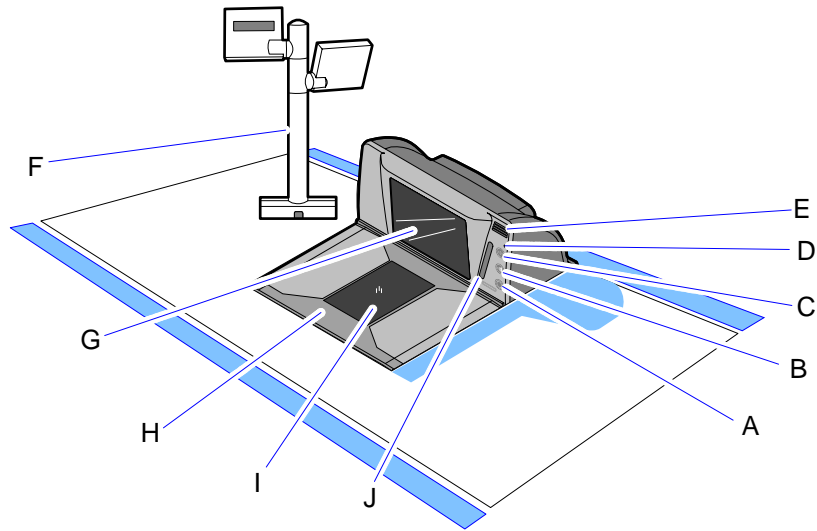

- A - Manual Deactivation
- B - Volume Adjust Button
- C - Scale Zero Button
- D - Motion Detector
- E - Speaker
- F - Remote Compact Display
- G - Vertical Scan Window
- H - Top Plate
- I - Horizontal Scan Window
- J - Scan Adviser Status Indicator 25893

## Operator Display Panel

The Operator Display Panel provides the interface to the operator. It contains the Motion Detector, Scan Adviser Status Indicator, Scale Zero button, Volume Adjust button, and Manual Deactivation Button.

### Motion Detector

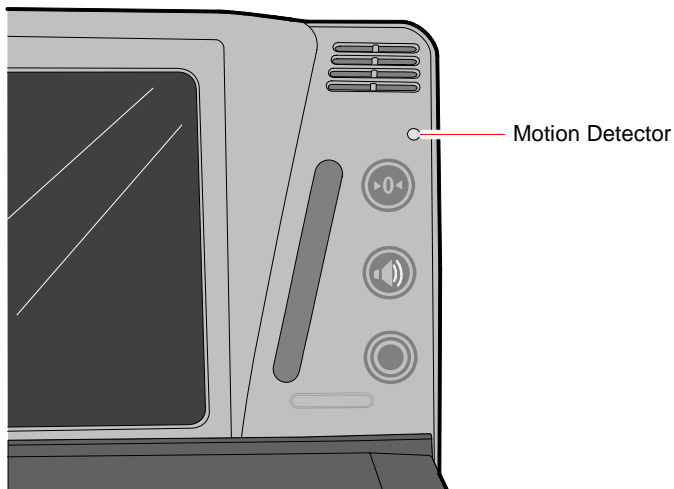

The Motion Detector is located at the upper-right of the Operator Display Panel. The laser diodes and spinner motor turn off after a user selectable period of operator inactivity. This prolongs the life of the 7874. The default non-active time is fifteen (15) minutes, but can be increased by programming. An item passing in front of the Motion Detector causes the 7874 to turn on. This movement is the normal item scanning movement.

### Scan Adviser Status Indicator

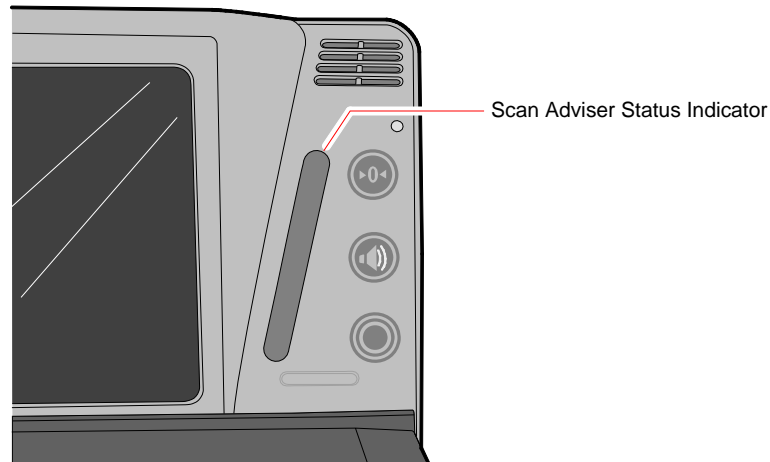

25509

The Scan Adviser Status Indicator is located diagonally to the left side of the Operator Display Panel buttons. The three center LEDs turn dim green when the 7874 is ready to read a bar code. When the scanner reads a bar code, all five LEDs light up brightly for an instant. During power-up, if the unit goes into the Failure Mode, the Scan Adviser Status Indicator displays a distinct LED pattern of colors to point to the probable scanner error code that is used by the field engineer to repair the unit. Voice messages are used to indicate errors as well. The Scan Adviser Status Indicator will display one dimly-lit green LED in the center when the 7874 enters sleep mode.

When using IBM-485 communications, the Scan Adviser Status Indicator slowly flashes a red-green-green pattern nine times, then delays, then repeats indefinitely when the 7874 does not detect the 12V TRMPWR voltage from the host terminal. It is still possible to successfully scan and weigh items with this Scan Adviser pattern displayed. Possible causes for this red-green-green indication may be one of the following:

- Host terminal is not turned on.
- Interface cable is not connected between the host terminal and scanner.
- IBM port 9x being used by the scanner is not generating the 12V TRMPWR signal.
- Rarely, there could be an issue with the scanner digital board not detecting the 12V coming from the host terminal.

Other interfaces can also disable the scanner under software control, resulting in all five LEDs on the Scan Adviser indicator turning dim RED.

When the scanner is disabled, no bar codes can be read.

### Scale Zero Button

The Scale Zero button is the top most button on the Operator Display Panel. The function of this button is reserved for 7874 Scanner/Scale models.

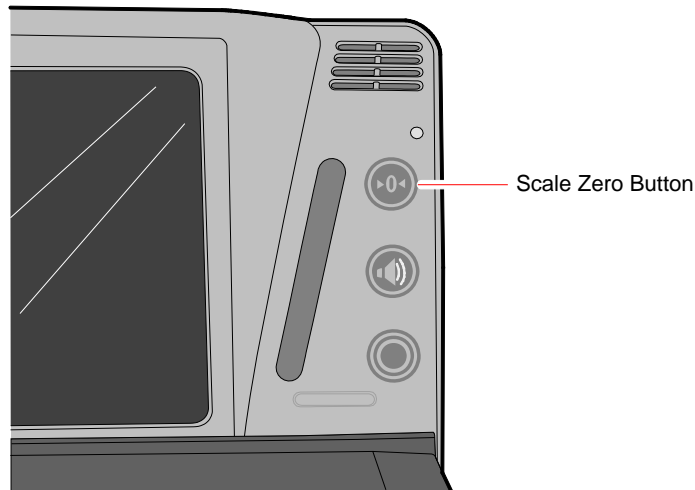

25340

The Scale Zero button resets the scale to zero within legal limits according to local Weights and Measures regulations.

### Volume Adjust Button

The Volume Adjust button is the middle button on the Operator Display Panel.

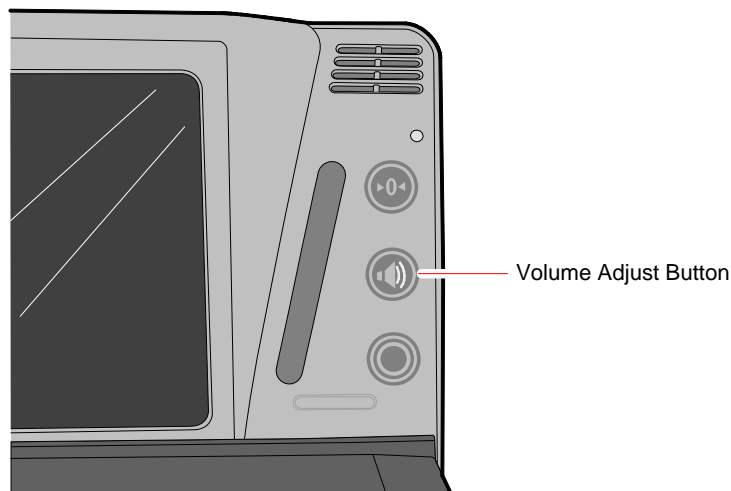

25341

The Volume Adjust button is used for two operations:



- **Controlling Speaker Volume**—Volume is controlled by pressing and then releasing the button. The Speaker emits a sound for each press/release of the button.
- **Controlling Speaker Frequency**—Frequency is controlled by continuous pressing of the button. The Speaker emits a sound and cycles through all different frequencies when the button is pressed continuously.

**Note:** Button Settings can be saved using the Reset Tag.

**Note:** Permanent changes to tone volume and frequencies require changes through programming. Refer to chapter 5 for more information.

### Manual Deactivation Button

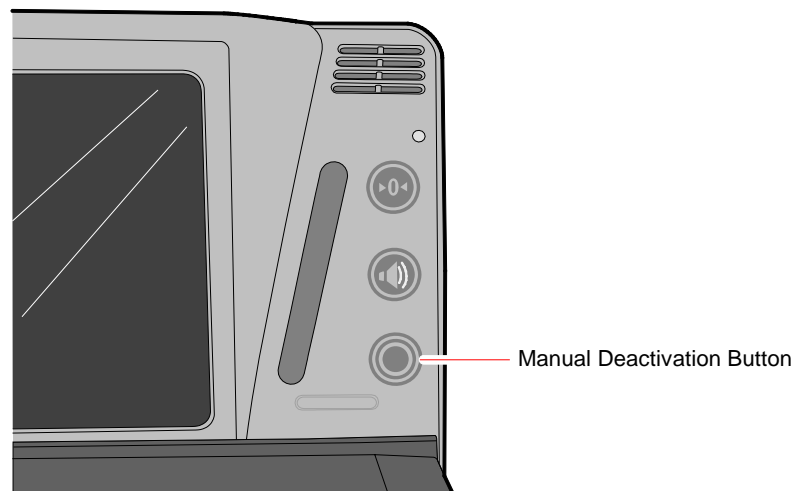

25342

The Manual Deactivation button is located at the lower-right corner of the Operator Display Panel. It permits the user to disable scanning and enable the Sensormatic deactivator for three seconds with each touch of the Manual Deactivation button on the Operator Display Panel. It also turns off the scanner laser to prevent reading the item bar code a second time.

## Remote Compact Display

Normally, the scale automatically re-zeros itself when there is no weight on the Top Plate. If the RealScan 25 Remote Compact Display (if fitted) is blank or indicates a weight other than zero, yet no weight is currently on the scale, pressing the Scale Zero button re-zeros the scale.

If “Error Code 5 --- “ displays on the RealScan 25 Remote Compact Display, remove any weight from the scale and press the **Scale Zero** button. If the error code persists, thoroughly clean the area under the Top Plate and try again before calling service.

**Note:** Refer to chapter 6 for other error codes and the steps to resolve these errors.

The RealScan 25 Remote Compact Display is used with scale units to display weight and scale status information. It connects to the back of the 7874 with a cable.

The display is also used to display error codes that indicate specific scale failures. When an error code is displayed, the scale does not operate until the error is corrected.

During scale calibration, certain messages are displayed on the remote display which provides guidance through the calibration procedure. Inspection audit trail information relating to calibration changes are also displayed when the Scale Zero button is pressed and held.

## Scan Adviser LED Scanner State Indicators

Scanner State		LED color	Brightness	Activity	Number of LEDs
Scan	Idle (Enabled)	Green	Dim	Solid	3 Center
	Enabled and in Sleep Mode	Green	Dim	Solid	1 Center LED
	Good Scan	Green	Bright	Solid	5 LEDs
	Disabled and Awake	Red	Bright	Solid	5 LEDs
	Disabled and in Sleep Mode	Red	Dim	Solid	1 Center LED
	Sleep Mode	Green	Dim	Solid	1 Center LED
	Scanner still sees just-read bar code	Green	Bright	Solid	3 Center LEDs
EAS	EAS Deactivated	Orange	Bright	Flash	5 LEDs
	AMB9010 Box – online	Orange	Dim	Solid	1 Button
	AMB9010 Box – online to offline	Orange	Dim	Flash (double flash, pause, double flash)	1 Button
Scale	At zero (stable)	Orange	Dim	Solid	1 Button
	Unstable with weight			OFF	
	Stable with weight	Orange	Bright	Solid	1 Button
	Underzero weight (stable)	Orange	Off/Bright	Flashing	1 Button
Volume	Volume Adjust	Orange	Bright	Solid	1 LED
	Tone Adjust	Orange	Bright	Solid	1 LED
	Idle			OFF	
Manual Deactivation	Manual deactivation	Orange	Dim	Solid	1 LED

## Speaker

A tone can be programmed to sound when the 7874 accurately reads a bar code. The tone provides a means of determining a good read without having to observe the Status Indicator.

The Good Read Tone can be enabled or disabled through programming. If the tone is enabled, its frequency, volume, and duration can be specified. The details for programming the tone are described in *Programming* chapter. The 7874 factory default has the tone enabled. To adjust the Good Read Tone volume temporarily, use the Volume Adjust button.

If voice is enabled, audible voice messages may be heard during the following events:

- When the Sensormatic® goes online or offline from the scanner
- When the Communications Protocol is checked
- When item tags are tested using PACESETTER Plus
- When certain error conditions occur
- When there is interference with the scale
- Generally during diagnostics, programming with tags and during power-on wellness check

## Vertical and Horizontal Scan Windows

The 7874 Vertical Scan Window is mounted in the tower cabinet that rises above the checkstand surface. The vertical scan pattern emanates from this window. The tower is designed to withstand occasional impact from elbows and purses.

The 7874 Horizontal Scan Window is flush-mounted in the stainless steel Top Plate. A scratch-resistant window is provided. The horizontal scan pattern passes through this window. The flush-mounted Horizontal Scan Window permits users to slide a product across the Top Plate without lifting the product.

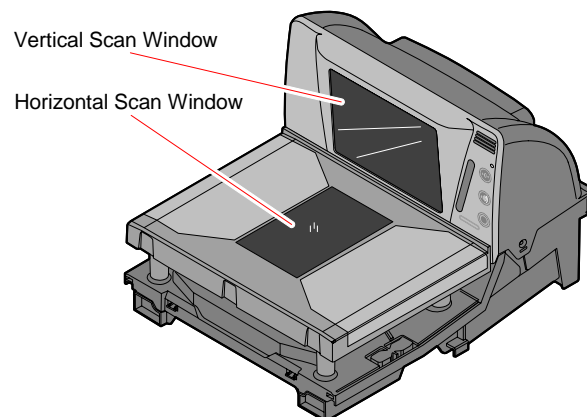

## Top Plate

The ruggedized plastic and steel Top Plate contains the Horizontal Scan Window. Items being scanned are passed from the checkstand, across the Top Plate, and back onto the checkstand. The checkstand construction permits the items to be slid along the surface without lifting the product (or Power slide, *see* the Scanning Procedure section below). The Top Plate also provides a surface for placing new items when weighing them.

Occasionally, dirt and debris can collect under the Top Plate. The Top Plate can be easily removed to clean these obstructions.

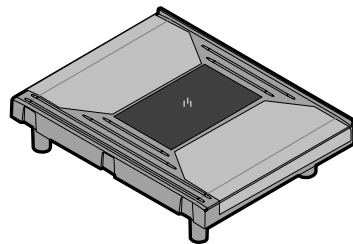

13.9 INCH

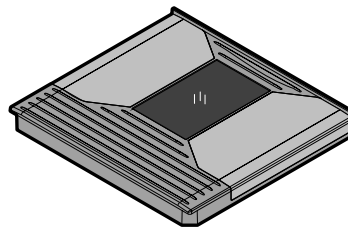

15.7 INCH

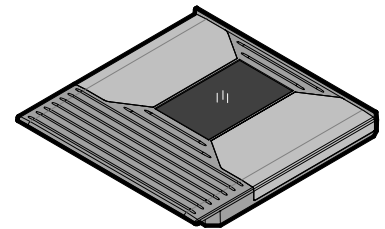

20 INCH

## Label Orientation

Because the 7874 produces an omni-directional scan pattern, bar code labels can be read from many different angles. The 7874 reads the labels on the leading side of a package, the trailing side, the bottom side, the top side, the side opposite the operator, and the side next to the operator. Products can be read from right to left or from left to right.

## Active Scan Zone

The active scan zone is the area where the unit can read a bar code label. The colored lines in the illustrations indicate this area. The illustration on the right shows the scan zone for the leading, trailing, bottom, and the back (opposite the operator) sides. The illustration on the left shows the top-down zone where the unit can read the top of an item and the front-up zone where the unit can read the front of an item.

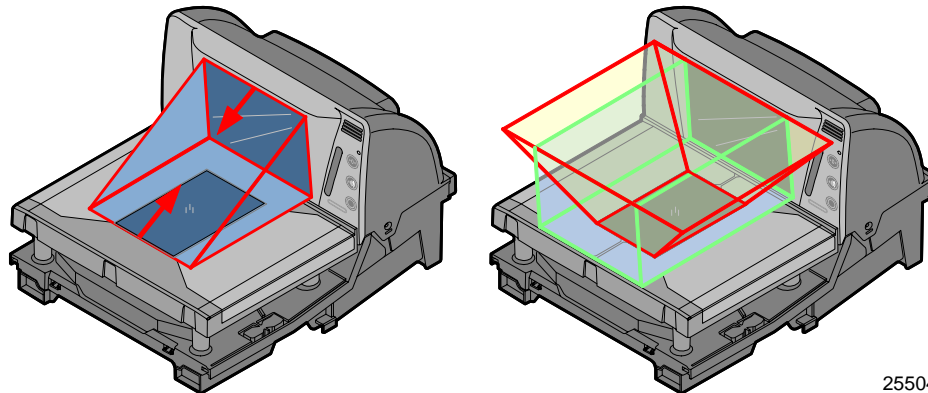

25504

## Multiple Reads

Only one good read is reported if a bar code label is placed on the scanner window and left there. The scanner firmware inhibits a second read of the same label if it occurs within a preset time of a good read. The preset time is programmable from 350 ms to 450 ms, then 450 ms to 1500 ms—in increments of 150 ms. The default is 450ms. To read the label a second time, remove the label from the scan window and scan the label again when the time-out period has elapsed.

# Operating Instructions

The 7874 is extremely easy to operate. However, there are certain functions and procedures that the operator needs to understand in order to be proficient at operating the 7874.

## Turning the 7874 On and Off

The 7874 does not have an ON/OFF switch. If powered by the 12V external power supply, turn on power by applying AC power to the external power supply. Turn off power by removing power from the AC power supply. For host terminal powered installations, turn on power by turning on the host terminal and turn off power by turning off the host terminal.

When power is supplied to the 7874, it performs specific diagnostics that check various components. If a scanner error occurs during these diagnostics, an error code tone sounds and the Scan Adviser flashes an error code. Call a supervisor, the Service Company, or NCR for assistance.

### Scanner Only Model

When power is applied, the Scan Adviser LEDs light up in a multi-colored progression (or the Scan Adviser starts out with five blue LEDs and transitions through a range of colors) and a tone sounds. The Scan Adviser's 3 center LEDs then turns green and the 7874 is ready to use.

### Scanner/Scale Model

When power is applied, the Scan Adviser Status Indicator LEDs light up and all segments on the display are turned on for five (5) seconds. Momentarily, the Scan Adviser flashes red, a tone sounds, and the RealScan 25 Remote Customer Display reads 0.000 kg or 0.00 lb. The Scan Adviser Status Indicator then turns green and the 7874 is ready to use.

## Scanning Procedure

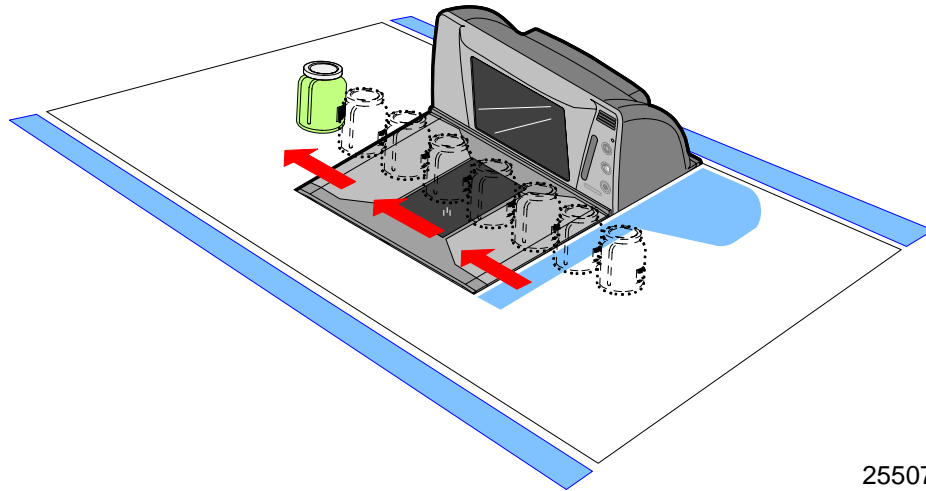

25507

To scan items with the NCR 7874, use the following procedure.

1. Verify the scanner is ready (Scan Adviser's 3 center LEDs are green).
2. Pass the item across the 7874 lower window. Slide the item from the checkstand, across the Top Plate, and back onto the checkstand.
3. If a good read occurs, the Scan Adviser flashes 5 green LEDs and a tone is emitted (if programmed).

If the Scan Adviser does not flash, the 7874 did not read the bar code label. Try to orient the label and scan the item again. If this does not work after two (2) more tries, manually enter information for the item. Then continue to scan.

## Weighing Procedure

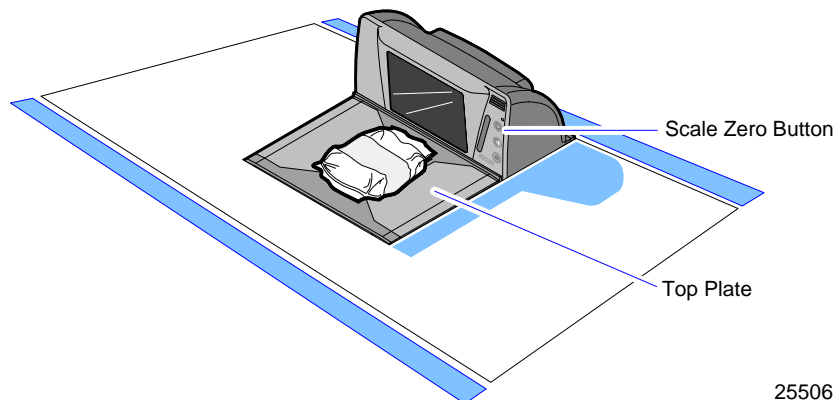

25506

Weigh items using the following procedure.

1. Verify the display reads 0.000 kg (0.00 lb).



**Note:** If 0.000 kg (0.00 lb) is not displayed, reset the scale by pressing the **Scale Zero** button. If this does not work, turn the scanner circuit breaker **OFF** and then **ON**.

2. Pick up the item and place it in the center of the Top Plate.

**Note:** Make sure the item does not overhang. Whatever is weighed must fit fully on the Top Plate.

3. Press the “weight request key” (for example, “4 0 1 1 [PLU]”) on the host terminal. The weight is communicated to the host terminal.

The following are possible responses after weighing an item:

- If enabled through programming, a Good Tone is emitted to indicate transmission of a stable, non-zero weight.
- If a bad weigh occurs, weigh the package again (Refer to Step 2.)
- If the Light Bar displays an error code, remove the item from the Top Plate. Then remove the Top Plate and check for debris under it. If there is debris, clean it. Replace the Top Plate, and then press the **Scale Zero** button to reset the scale.
- Wait for the *0.000 kg (0.00 lb)* message to be displayed. When it is displayed, weigh the item again.

**Note:** If the Light Bar still displays an error code, contact a supervisor, the Service Company, or NCR Customer Services.

## Sensormatic® Security Tag Deactivation Procedure

### Normal Operation

The operating procedures can vary according to the parameter settings. The following procedure assumes the Sensormatic® parameters are set to the following values.

- Security tag deactivation function is enabled
- Security tag deactivated tone is enabled
- Security tag detected tone is enabled

Following this procedure assumes the 7874 and the Sensormatic® AMB9010 Controller are turned on and functioning properly.

1. Pass an item across the scanner.

**Note:** As the bar code goes through the scan zone, the 7874 reads it.

**Note:** As the security tag goes through the Sensormatic® Deactivation zone, the Sensormatic® system deactivates the security tag and the deactivation tone is produced by the scanner. If the security tag is not deactivated, a clicking tone is generated. Both options can be changed through firmware programming.

2. Place the item against the gray label (area above the deactivation coil). The clicking tone stops when the security tag is deactivated.

The security tag must be detected by the Sensormatic® system before the Scan Enable Timer expires or it is not deactivated even when it does come into the deactivation zone. In this case, the Security tag Detected Tone sounds while the tag is in the deactivation zone. The sound is a rapid clicking. When this condition occurs, the security tag must be deactivated manually. These options can be changed through firmware programming.

### Manual Deactivation

If for some reason the security tag is not deactivated through normal operation, it can be deactivated manually. This usually occurs when too much time elapses after the 7874 reads the bar code. There are two ways to initiate a manual security tag deactivation.

- Press the Manual Deactivation Button on the 7874. The 7874 laser light turns off, disabling the scanner.
- Pass the Security Tag into the deactivation zone. The Security Tag Detected Tone sounds (a rapid clicking) and the tag is deactivated and the deactivation tone is heard. If the deactivation tone is heard first, the detection tone will not be heard if the EAS tag is deactivated.

**Note:** The laser light is turned off for manual deactivation to keep the scanner from reading the bar code a second time.

## Adjusting the Good Read Tone

The 7874 has a Volume Adjust button that permits the operator to change the scanner's Good Read Tone Volume to a comfortable level depending on the ambient noise level at that time.

Each time the button is momentarily pressed, the Good Read Tone changes its volume and sounds a Good Read Tone using the new setting. Repeatedly pressing the Volume Adjust button increases the volume to the maximum setting and then repeats the cycle from minimum back up to maximum. However, the scanner reverts to the programmed volume setting on each power-up.

*See also "Volume Adjust Button" section in this chapter.*

**Note:** Button Settings can be saved using the Reset Tag.

Permanent changes to tone length, tone volume, and tone frequency require changes through programming. To adjust the tone length, volume, or frequency, refer to the following table:

Settings	Programming steps	Expected Behavior
Increment Good Tone Length	Repeatedly scan/enter the programming sequence <b>Programming Mode, Hex 1, Hex 1, Hex C, Save &amp; Reset</b> until the desired tone length is achieved.	Scanner tone length changes from max to min or vice versa.
Increment Good Tone Volume	Repeatedly scan/enter the programming sequence <b>Programming Mode, Hex 1, Hex 1, Hex D, Save &amp; Reset</b> until the desired tone volume is achieved.	Scanner tone volume changes from max to min or vice versa.
Increment Good Tone Frequency	Repeatedly scan/enter programming sequence <b>Programming Mode, Hex 1, Hex 1, Hex B, Save &amp; Reset</b> until the desired tone frequency is achieved.	Scanner tone frequency changes from max to min or vice versa.

## Not-On-File Error

The Not-On-File feature is available on the 7874 only if the host terminal has this capability. If a bar code label is not in the price lookup file, a special tone sounds six (6) times within a second and the Scan Adviser LEDs are solid red. The volume of the Not-On-File tone is programmable.

The 7874 is disabled from reading additional tags until the error is cleared. To clear, press the host terminal **CLEAR** key and manually enter the item and price.

## Cleaning Instructions

The 7874 should be kept in good operating condition by performing the following routine maintenance. Keeping the scan windows clean helps keep the read rate exceptionally high. During normal operation of the 7874, the Horizontal Scan Window gets dirty. If dirt is permitted to accumulate, performance degrades to the point where the scanner can no longer read bar codes. The Horizontal Scan Window should be cleaned at least once a day.

**Note:** Before cleaning the 7874, ensure that the scanner is OFF.

**Note:** When cleaning the 7874, do not spray or pour lukewarm water onto the 7874. Moisten a soft cloth with lukewarm water, and then wipe the components.

### Scanner Body

Clean the scanner body using the following.

- Soft cloth dampened by lukewarm water and mild soap.
- Soft, dry cloth to wipe the surface dry.

Clean the scanner body using the damp cloth first, followed by the dry cloth to finish.

### Vertical Scan Window

Clean the Vertical Scan Window with a soft cloth dampened with lukewarm water.

### Top Plate and Horizontal Scan Window

1. Remove the Top Plate with the Horizontal Scan Window and clean the glass using a soft cloth moistened with lukewarm water.
2. Clean the plastic cover that is under the Top Plate (and the window with it) by wiping the surfaces with the moistened cloth.

**Note:** Do not scrub the clear plastic cover excessively or use excessive force during the cleaning process. Ensure to remove any debris that may be accumulated on this plastic cover.

3. Replace the Top Plate.

## *Chapter 5:* **Programming**

---

The 7874 can be programmed to meet most installation requirements. This includes communications with the host terminal and various 7874 features and functions.

## Programming Description

The 7874 can be remotely programmed from its attached host terminal with no local intervention. To achieve this, special host terminal software must be purchased from NCR. This section describes programming a scanner with special bar code tags.

Programming the 7874 consists of setting programming parameters to match specific needs. This is accomplished by scanning a specific sequence of programming tags. The factory sets most programming parameters to default values or values originally specified. In most installations, few, if any, programming changes need to be made.

## Creating the Program

Creating a program consists of three basic steps. Details of these steps are given in various areas of this programming information.

### Write the Program

1. *Identify requirements.* The first thing is to determine the requirements of the 7874 installation. This includes information about the communications protocol, the types of bar codes to be scanned, the use of good read tones, and scanner time-outs.

**Note:** NCR does not control or specify the NCR scanner configuration required to support specific Host Terminal Software unless you are using NCR Host Terminal Software. You should consult with your Host Terminal Software vendor or reseller to determine the correct configuration for your NCR scanner.

2. *Complete the programming worksheets.* Using the descriptions contained in this document, complete each programming worksheet. Write the entries of the program in the space provided. Refer to the "Programming Worksheet" section in Chapter 5 for specific information about each parameter.

### Enter the Program

1. *Enter the programming mode.* Scan the **Program Mode** tag. This must be the first tag scanned after supplying power to the 7874 (or the first tag after scanning the **Reset** tag).
2. *Enter the parameters for each specific program.* Scan the two **Hex** tags to select a specific program, and then enter all parameter data for it. After all the information has been entered, the 7874 returns to programming mode. Repeat this procedure for each specific program that needs to be changed.

**Note:** A specific program does not need to be entered if its associated programming is already correct.

## Save the Program

1. *Scan the **Save and Reset tag**.* When the **Save and Reset tag** is scanned, the scanner saves all programming parameters entered. This becomes the new scanner program. The scanner goes through initial startup and operates using the new program.
2. *Save programming worksheets.* Be sure to save the programming worksheets that contain the scanner program. It is much easier to reenter the program, or change some of it, if a written record of the program exists.

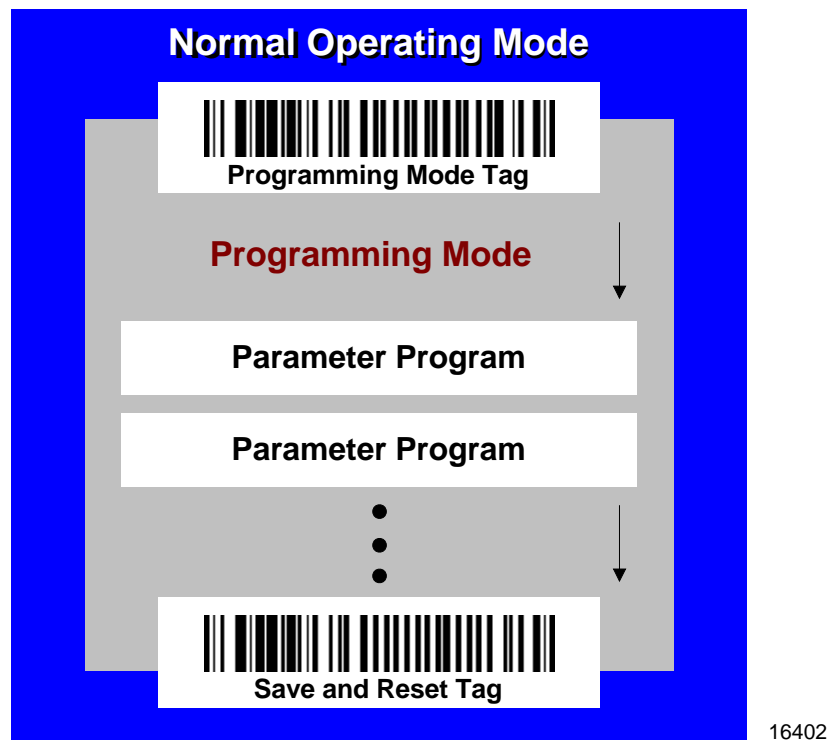

## Programming Tags

After completing the worksheets, enter the information using the special programming tags contained in the *NCR Scanner Programming Tags* (BST0-2121-74) available at [www.info.ncr.com](http://www.info.ncr.com). (The tags are also included in Appendix A of this document.) A large number of special programming tags are not needed. There are only five (5) unique tags and sixteen (16) hexadecimal (Hex) character tags. The following identifies each programming tag, its function, and the associated indicators.

### ABORT

#### *Function–In Base Program Mode*

If the **Abort** tag is scanned in the Base Program Mode, programming is terminated and previously entered parameters are not saved.

*Indication–In Program Mode*

- Scan Adviser Status indicator is initially 3 center LEDs dim green and then flashes bright green (5 LEDs) showing the tag was read. Scanner will reboot and perform power up sequence (the Scan Adviser turns off momentarily, then comes on with 5 bright blue LEDs followed by a gradual change to bright green, then back to normal state of the center three LEDs at dim green).
- Short beep as soon as tag is read—Good Read tone
- Motor stop momentarily while scanner reboots, then they come up to full speed

*Function–In a Parameter Programming*

If this tag is scanned in a Parameter Program sequence, only the parameter sequence which was aborted is not saved. Any prior sequence that successfully ended with the scanner saying "Program Mode" is saved and the 7874 stays in Program Mode.

*Indication–In a Parameter Program*

- Scan Adviser Status indicator flashes green (5 LEDs) once and then returns to 3 dim green LEDs in the center
- Short beep as soon as tag is read—Good Read tone
- Programming returns to Program Mode
- Scanner beeps to indicate it accepted the **Abort** tag, and then says "Program Mode"

**DEFAULT***Function*

This tag causes most parameters to reset to default values. However, scanning this tag does not change a few parameters, including the Communications Protocol. The **Default** tag must be scanned first after applying power to the 7874

**Note:** The **Default** tag is not used while in Programming Mode

*Indication*

- Speaks "Set new default parameter complete", Scan Adviser will flash 5 LEDs bright green after speaking and beep once.
- Performs power-up sequence (the Scan Adviser turns off momentarily, then comes on with 5 bright blue LEDs followed by a gradual change to bright green, then back to normal state of the center three LEDs at dim green).



## END

### *Function*

This tag ends certain input sequences. Since the parameter program determines the end of most sequences, this tag is not used often.

### *Indication*

- Scan Adviser Status indicator is initially 3 center LEDs dim green and then flashes bright green (5 LEDs) showing the tag was read.
- Short beep as soon as tag is read—Good Read tone.
- Scanner beeps to indicate it read the **End** tag, then it says “Program Mode” as it goes into Program Mode.

## HEX 0–HEX F

### *Function*

These sixteen (16) tags enter the selections for each of the parameters in the Parameter Programs. They also select the Parameter Program

### *Indication*

- **Hex 0**—Scanner says “Zero” with no beeps. If voice disabled, scanner produces a short beep, different frequency from Good Read tone.
- **Hex 1 through Hex F**—Scanner says “<tag value>” with no beeps. If voice is disabled, the scanner produces a number of beeps according to the tag value. Multiples of 4 short beeps grouped together.

**Example: Hex D** Scanner says “D”. If voice is disabled, Hex D is indicated by 12 short beeps (3 sets of 4) followed by 1 beep, for a total of 13.

## PROGRAM MODE

### *Function*

This tag sets the 7874 into Program Mode. It must be the first tag scanned after applying power to the 7874, or after scanning the **Default** tag or the **Reset** tag.

### *Indication*

- Scan Adviser Status indicator is initially 3 center LEDs dim green and then flashes bright green (5 LEDs) showing the tag was read.
- The scanner says “Program Mode” with no beeps.
- If Voice NOT enabled, Short beep, long beep, short beep—indicates Program Mode

## SAVE AND RESET

### *Function*

This tag instructs the 7874 to save and start using the programming data. It is used in the Program Mode.

### *Indication*

- Scan Adviser LEDs flashes five LEDs red twice, then Scanner will reboot and perform power up sequence (the Scan Adviser turns off momentarily, then comes on with 5 bright blue LEDs followed by a gradual change to bright green, then back to normal state of the center three LEDs at dim green).
- Short beep as soon as tag is read—Good Read tone
- Motor stops momentarily while scanner reboots, then they come up to full speed.
- One beep when the scanner has completed power cycling.
- Reboots with no voice.

## SPEAK BAR CODES CURRENTLY ENABLED

This bar code prompts the scanner to speak a list of the bar code symbologies that the scanner has been programmed to recognize and read.

### *Indication*

- The three center LEDs in the Scan Adviser stay dim green.
- Scanner begins speaking as soon as bar code is scanned. It talks and lists all the bar codes currently enabled in the scanner.

**Example:** “UPC EAN is ON, Periodical P2 is ON...Periodical P5 is ON...Code 128 is ON.”

- Scanner beeps when it is done speaking the enabled symbologies.

## SPEAK SCANNER SERIAL NUMBER

This bar code enables the user to obtain the scanner Serial Number without having to remove the scanner from the checkstand (if installed) and looking at the manufacturing name plate label on the back of the unit.

### *Indication*

- The three center LEDs in the Scan Adviser light up bright green while it is speaking, then go back to dim green when it's done.
- As soon as the scanner reads the bar code, it says “Scanner S N” then speaks all 10 digits.

- If the scanner says “Scanner S N 0 0 0 0 0 0 0 0 0”, then the actual serial number is NOT stored in memory.
- The scanner beeps when it is done speaking the serial number.

## Program Entry Procedure

### Enter All Parameters

To enter all parameters in a Parameter Program, scan the two Hex codes that set the 7874 in the Parameter Program, and then make parameter changes in the order described on the programming worksheet for that mode. When programming all parameters in a specific mode, proceed directly through the work sheet. When making a change in a parameter, the scanner proceeds to the next parameter to be changed or it goes back to Program Mode if the selection ends programming in that particular Parameter Program.

The following figure shows how to proceed through a Specific Programming Mode where all parameters are entered. It presents the Parameter Program for the Bar Codes 2 program parameters. The figure shows how to proceed through the Parameter Program by entering all available parameters. Notice that (in this example) if Code 39 bar codes are disabled, programming immediately returns to Program Mode. However, if Code 39 bar codes are enabled, the scanner directs the user to continue entering parameter information.

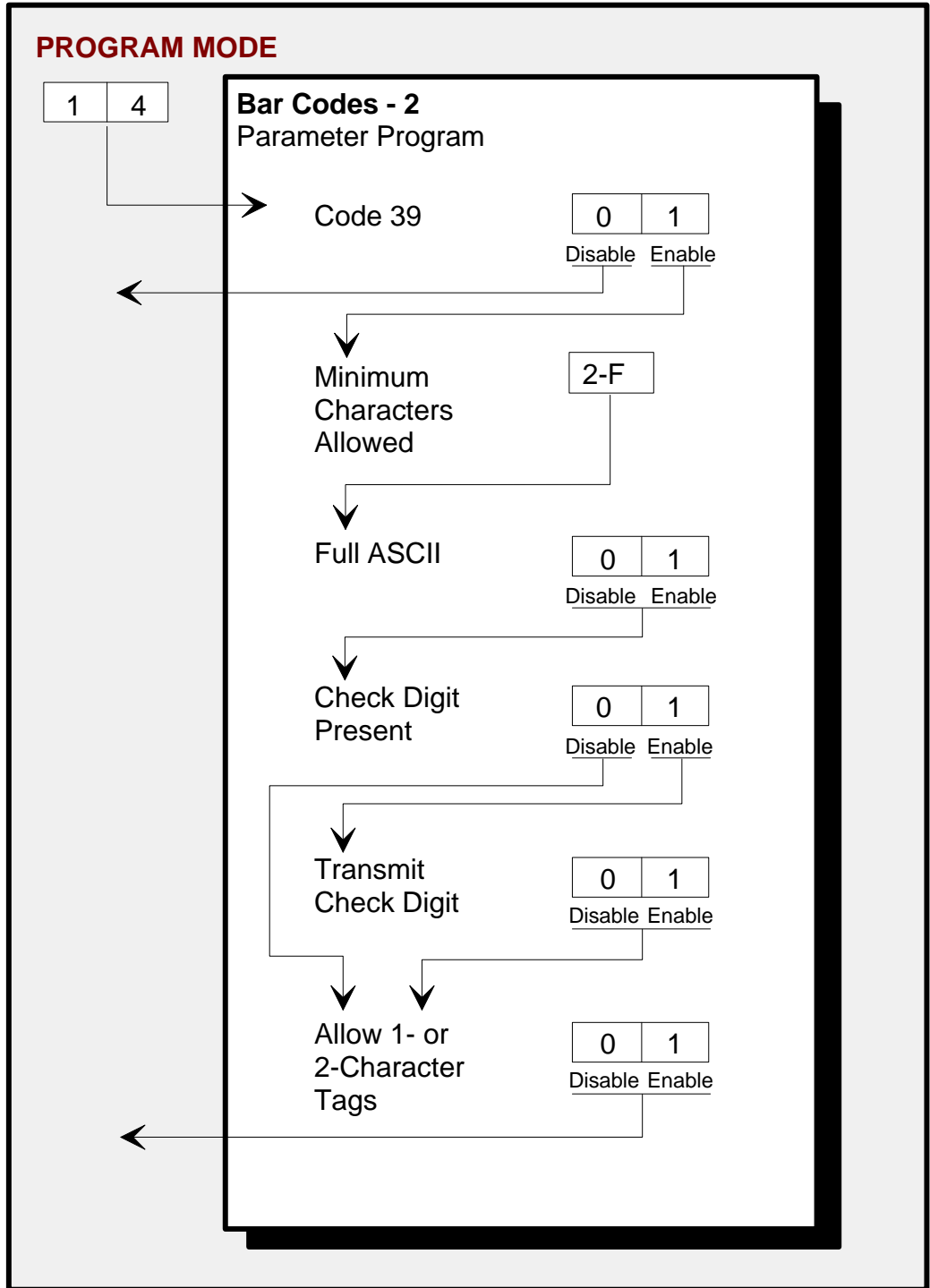

### *Program Entry Procedure*

The following example is a typical program entry procedure.

1. Disconnect scanner from host terminal.
2. Apply power to the 7874 (or scan the **Reset** tag).
3. Scan the **Program Mode** tag.
4. Scan the two Hex tags corresponding to the worksheet number.
5. Scan appropriate Hex tags to enter parameters.
6. Repeat steps 4 and 5 until all the parameters are entered.
7. Scan the **Save and Reset** tag. All parameter changes are saved and 7874 is reset (goes through initial power-up sequence). The 7874 now operates using the new program.

### Enter Specific Parameters (Shortcut Method)

To enter only one specific parameter in a Parameter Program, scan the two *numbered* Hex tags that correspond to that Parameter Program. However, once the Parameter Program has been entered instead of immediately changing parameters with numbered Hex tags, use the *lettered* Hex tags to choose the one particular parameter to be changed. After the new parameter setting has been selected, the scanner immediately returns to Program Mode. If one decides to do additional programming with these parameter options, reenter the Parameter Program by scanning the two Hex tags again.

The following figure shows how to proceed through a Parameter Program where shortcuts are used to change only one of the parameters. This figure presents the Parameter Program for Bar Codes 2 program parameters. Notice that once the Parameter Program has been entered, if the **Hex A**, **Hex B**, **Hex C**, **Hex D**, **Hex E**, or **Hex F** tag is scanned, the specific parameters that correspond to that tag can be entered. After recording the parameters, the scanner immediately returns to Program Mode. To return to programming, scan the **Hex 1** and **Hex 4** tags again and reenter the Parameter Program. From this point, enter either all parameters or another specific parameter.

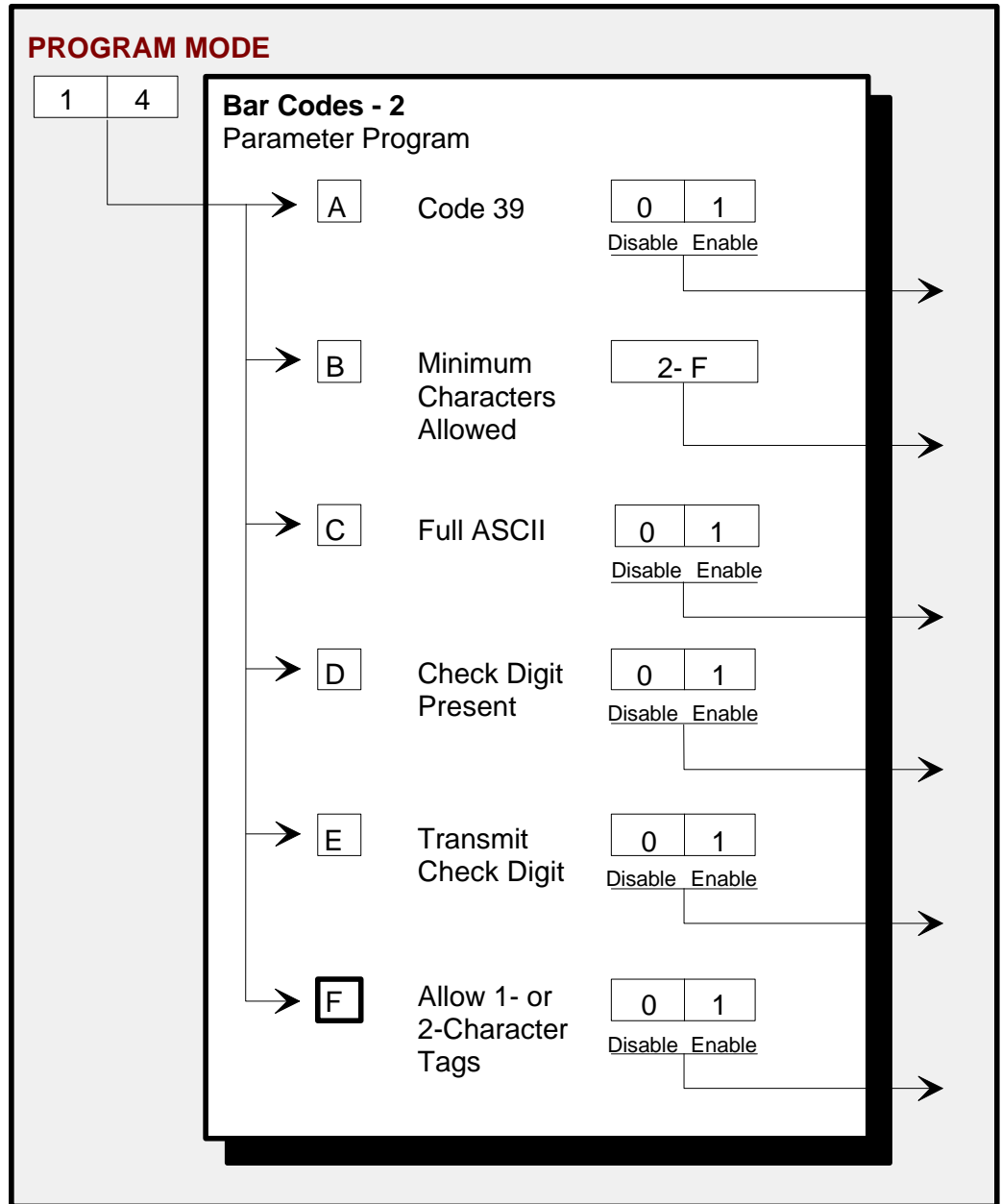

**Program Entry Procedure (Shortcut Method)**

The following example is a typical program entry procedure.

1. Disconnect scanner from host terminal.
2. Apply power to the 7874 (or scan the **Reset** tag).
3. Scan the **Program Mode** tag.
4. Scan the two Hex tags corresponding to the worksheet number.
5. Scan specific parameter tag (**Hex A–F**).
6. Scan appropriate Hex tags to enter parameters.
7. Repeat steps 4 thru 6 until all the parameters are entered.
8. Scan the **Save and Reset** tag. All parameter changes are saved and 7874 is reset (goes through initial power-up sequence). The 7874 now operates using the new program.

## Parameter Defaults

Programming Mode	Program Parameters	Default Setting
Communications Protocol	Protocol	No default value—remains as programmed
Good Read Tone	Tone On/Off	On
	Tone Frequency	1071 Hertz
	Tone Length	45 ms
	Tone Volume	Third Lowest Volume
	Not-On-File Volume	Second Lowest Volume
Timers	Lockout Time	450 Milliseconds
	Restart Lockout Timer	On
	Active Time	15 Minutes
	900ms Lockout Timer Restart Limit	Off

Programming Mode	Program Parameters	Default Setting
Bar Codes-1	UPC/EAN	Enable
	Unused	Disable
	Extend UPC-A to EAN-13	Disable
	Extend UPC-E to UPC-A	Disable
	Periodical Codes	Disable
	Periodical Code Extension	No default value
	Send Data	Data As Decoded
	Set 2 Tag Label	Off
Bar Codes-2	Code 39	Disable
	Minimum Characters Allowed	8
	Full ASCII	Disable
	Check Digit Present	Disable
	Transmit Check Digit	Disable
	Allow 1- or 2-Character Tags	Disable
	Code 39 Tone	Disable
	Tone Length	75 Milliseconds
	Tone Frequency	1071 Hertz
	Code 39 Halves Enable	Disable
	Code 39 Stitch Enable	Disable
	Code 39 Check Digit Length 1	0 0
	Code 39 Check Digit Length 2	0 0
	Code 39 Specific Length	0
	Code 39 Minimum Length	0 3
	Code 39 Maximum Length	3 6
	Scans Required	1 scan
	Overlap Characters	2
Minimum Segment Size	3	



Programming Mode	Program Parameters	Default Setting
Bar Codes-3	Interleaved 2 of 5	Disable
	Bar Code Length	Range Specific
	Value 1	0 8
	Value 2	1 6
	Check Digit Present	Disable
	Transmit Check Digit	Disable
	Interleaved 2 of 5 Tone	Disable
	Tone Length	75 Milliseconds
	Tone Frequency	1071 Hertz
	Interleaved 2 of 5 Check Digit Length 1	0 0
	Interleaved 2 of 5 Check Digit Length 2	0 0
	Scans Required	2 scans
	Overlap Characters	1
	Minimum Segment Size	3
Bar Codes-4	Code 128	Disable
	Minimum Data Character Allowed	3
	EAN/UCC 128	Disable
	Partial Decoding	Disable
	Code 128 Tone	Disable
	Tone Length	75 Milliseconds
	Tone Frequency	1071 Hertz
	Stitch Tag	Disable
	Scans Required	1 scan
	Overlap Characters	2
	Minimum Segment Size	4
Bar Codes-5	GS1 DataBar Enable	Disable
	Scan Required on GS1 DataBar-14	1 Scan
	UCC-128 Emulation Mode	Normal Mode

Programming Mode	Program Parameters	Default Setting
Bar Codes-6	Codabar Decoding	Disable
	Codabar Length Range Check	4-36
	Codabar Specific Length Check	4-36
	Codabar Check Digit	Disable
	Codabar Check Digit Transmission	Enable
	Codabar Tone Length	75 ms
	Codabar Tone Frequency	1071 Hertz
	Codabar Tone	Disable
	Codabar Halves	Disable
	Codabar Stitch	Disable
	Codabar Require Start/Stop Match	Disable
	Codabar Require Quiet Zones	Disable
	Codabar Start/Stop Transmission	Enable
	Codabar Hard Correlation	Disable
Number of Codabar Scans Required	1 Scan	
Bar Codes-7	Pharmacode Decoding	Disable
	Pharmacode Check Digit Transmission	Enable
Label Identifiers	Identifier Type	Default Prefix
	Common Byte 1	5 D
	Common Byte 2	4 2
	<b>Note:</b> Default identifiers for each bar code type are available under Program Parameter Descriptions/Label Identifiers section of this chapter.	
Additional Bar Codes Options	UPC Number System Character	Send
	UPC-E Number System Character	Send
	UPC-A Number System Character	Send

Programming Mode	Program Parameters	Default Setting
RS232 Parameters-1	Baud Rate	9600
	Parity	Odd
	Stop Bits and Character Length	1 Stop Bit and 7-bit Length
	Hand Shake	RTS High, Wait For CTS
RS232 Parameters-2	BCC Options	Disable—Scanner-Only models Enable—Scanner/Scale Models
	Interface Control	None
	Check Digit	Enable UPC-A
		Enable EAN-8
		Enable EAN-13
Disable UPC-E		
RS232 Prefix Byte	Prefix Byte	Disable
	ASCII Code	0 2
RS232 Terminator Byte	Terminator Byte 1	Enable
	ASCII Code	0 3
	Terminator Byte 2	Disable
RS232 Communications Options	Message Delay	10 ms Delay
	Scanner or Scanner/Scale Format	No default value
	Good Weigh Tone	Disable

Programming Mode	Program Parameters	Default Setting
Scale Parameters	Model Number	No default value
	IBM Address	Address 6E set by selecting IBM 468x on Communications Protocol Worksheet
	Vibration Filter	Normal Vibration Filter
	Display Mode	Argentina Cero Display Mode
Miscellaneous Parameters	Host Tone Control	Disable
	IBM Retransmit Control	3 times
	Enable/Disable Voice Messages	No default setting
	IBM-485 / IBM-USB Tag Data Format	Hex

## Programming Tips

The following are some tips to help when programming the 7874.

- Turn the host terminal Off or disconnect all interface cables to the 7874 before entering the program. Some host terminals can corrupt the program if they are running and are connected to the 7874 while entering the program.
- To exit a Parameter Program without entering all the parameters, scan the **Abort** tag. Only the parameter sequence which was aborted is not saved. Any prior sequence that successfully ended with the scanner saying "Program Mode" is saved. To save the changed parameters, scan the **Save and Reset** tag.
- To exit programming mode without saving any parameter changes, scan the **Abort** tag while in Program Mode. The 7874 goes through initial startup and operates using the old program.
- If unknown how the 7874 is programmed, set all parameters to default values, then enter any required changes. Do this by scanning the **Default** tag first after applying power to the 7874. Next, scan the **Program Mode** tag to enter the Program Mode and enter the programming changes.

**Note:** Some parameters do not have default values and are not changed when the **Default** tag is scanned.

# Program Parameter Descriptions

Within the Program Mode are several Parameter Programs. Each of these has specific programming parameters.

## Communications Protocol

### Your Program

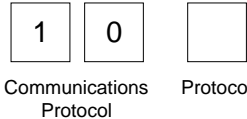

### Protocol

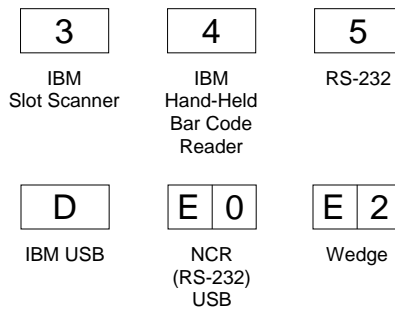

24036

The Communications Protocol programming mode selects the protocol that the 7874 uses to communicate with the host terminal.

**Note:** The factory sets the Communications Protocol according to the specifications on the order. Since there is no default Communications Protocol; the **Default** tag does not change this parameter.

### IBM Slot Scanner

All models of the 7874 support the IBM 468x/9x format and use the same protocol found on IBM host terminals. The scanner uses any port number beginning with 9 or 5 (as in 9B or 5B) and the select address is set to 4B.

### IBM USB

The 7874 can communicate to the host terminal through a USB cable. This parameter enables the scanner to use IBM's proprietary version of HID-type USB protocol.

### NCR (RS232 USB)

The 7874 can communicate with the host terminal through a USB cable. This parameter enables the NCR (RS232) format.

**Note:** Two programming tags must be scanned to enable this parameter: **Hex E** followed by **Hex 0**.

## RS232

RS232 is used to connect the 7874 to almost any RS232 type of communications device. This protocol uses 7-bit ASCII by default to send tag data to the device.

## Good Read Tone

### Your Program

1	1	
Good Read Tone	Protocol	

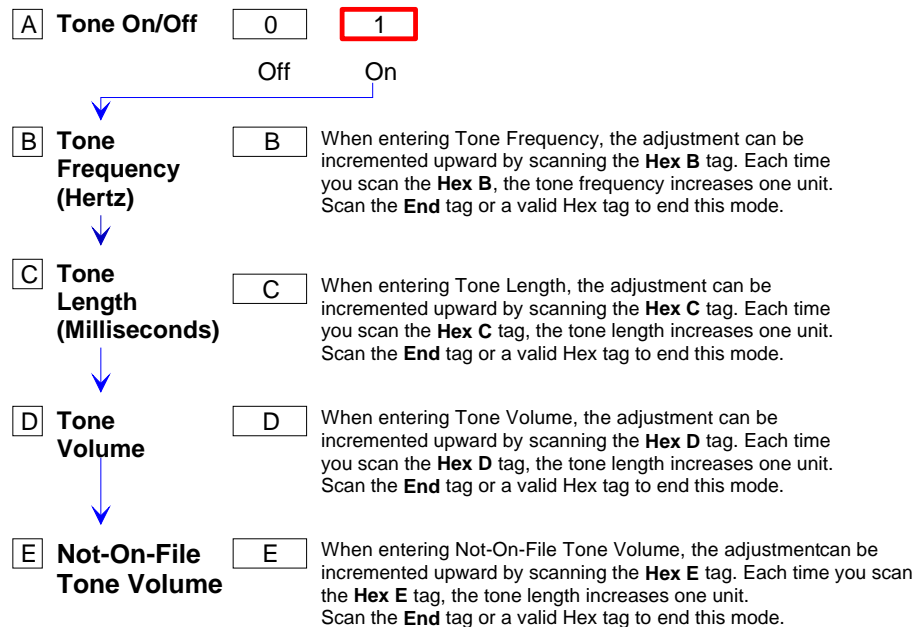

22761

The Good Read Tone programming mode selects the parameters for sounding a tone each time the 7874 successfully reads a bar code. It also controls the volume of the Not-On-File tone. This mode contains five shortcuts: A, B, C, D, and E. After entering this programming mode, proceed directly to a specific parameter by scanning the appropriate shortcut Hex tag. This eliminates the need to enter all parameters when only one needs changing. Refer to the “Parameter Defaults” section earlier in this chapter for the factory defined default value of each programming parameter.

### Tone On/Off

The **Hex A** tag selects the Tone On/Off programming parameter, which offers two options, On and Off. The **Hex 0** tag turns the Good Read Tone off and the **Hex 1** tag turns the Good Read Tone on.

### Tone Frequency (Hertz)

The **Hex B** tag sets the frequency of the Good Read tone. Each time the **Hex B** tag is scanned, the tone increments one unit. After reaching the highest frequency, the sequence starts over with the lowest frequency. End this mode by scanning the **End** tag or another valid Hex tag.

The Good Read Tone frequency can have one of the following eight values:

702 Hz

781 Hz

868 Hz

961 Hz

1071 Hz

1187 Hz

570 Hz

633 Hz

### Tone Length (Milliseconds)

The **Hex C** tag sets the length of the Good Read Tone. Each time the **Hex C** tag is scanned, the tone length changes from the shortest to the longest, and then back again. End this mode by scanning the **End** tag or another valid Hex tag.

The Good Read Tone length is from 15 ms to 225 ms in 15 ms increments (15 total values).

### Tone Volume

The **Hex D** tag selects the volume of the Good Read tone by increasing it as the **Hex D** tag is repeatedly scanned. After the loudest volume is reached, the sequence begins again with the softest volume. End this mode by scanning the **End** tag or another valid Hex tag.

There are eight different volume settings available on the 7874. However, there is a programming sequence which allows the user to access eleven volumes. Refer to the Volume Adjust section in this chapter for details on activating the eleven volumes and other functions of the volume button.



### Not-On-File Volume

The **Hex E** tag sets the volume of the Not-On-File tone by listening to it as the **Hex E** tag is repeatedly scanned. The new tone sounds for two seconds. End this mode by scanning the **End** tag or another valid Hex tag.

The Not-On-File tone goes off when the scanner receives a command from the host terminal to do so. In RS232 protocol, there is a Not-On-File command. Refer to the *NCR Scanner/Scale Interface Programmer's Guide* (BD20-1074-A) for more information about the Not-On-File command.

# Timers

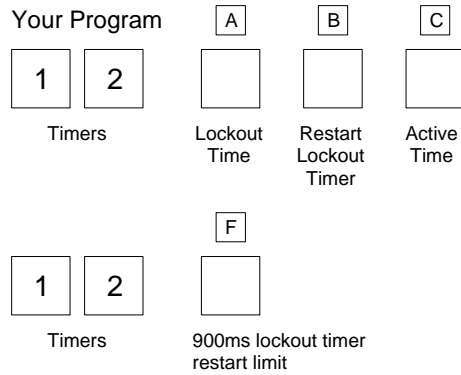

<b>A</b>	<b>Lockout Time (Milliseconds)</b>	<input type="text" value="8"/>	<input type="text" value="0"/>	<input type="text" value="1"/>	<input type="text" value="2"/>	<input type="text" value="3"/>
		350	450	600	750	900
		<input type="text" value="4"/>	<input type="text" value="5"/>	<input type="text" value="6"/>	<input type="text" value="7"/>	
		1050	1200	1350	1500	
<b>B</b>	<b>Restart Lockout Timer</b>	<input type="text" value="0"/>	<input type="text" value="1"/>			
		Off	On			
<b>C</b>	<b>Active Time (Minutes)</b>	<input type="text" value="0"/>	<input type="text" value="1"/>	<input type="text" value="2"/>	<input type="text" value="3"/>	
		0	15	30	60	
<b>F</b>	<b>900ms Lockout Timer Restart Limit</b>	<input type="text" value="0"/>	<input type="text" value="1"/>			
		Disable	Enable			

**NOTE:** Direct Entry Only.  
If the Restart Lockout Timer [B] is set to OFF, the 900 ms Lockout Timer Restart Limit [F] has no effect.

**NOTE:** NCR suggests that you do not set the Active Time parameter to 0. Leaving the laser light on all the time reduces its life expectancy.

27550

The Timers programming mode controls the two 7874 timers: Lockout Time and Active Time. Refer to the “Parameter Defaults” section earlier in this chapter for the factory defined default value of each programming parameter.

## Lockout Time

The lockout timer prevents the scanner from repeatedly reading the same bar code. After reading a bar code, it must be removed from the scan pattern and the time programmed in the lockout timer must elapse before the scanner can read the same bar code again. The Lockout Time parameter selects the lockout time.

There are 9 specific times ranging from 350 milliseconds to 1500 milliseconds. Select these times using the **Hex 0** through **Hex 8** tags.

### Restart Lockout Timer

The Restart Lockout Timer parameter controls restarting the lockout timer each time the scanner reads the same bar code. Turning on the Restart Lockout Timer option has the following effect. If a bar code moves out of the scan pattern after being read and then back into the scan pattern before the lockout timer times out, the lockout timer restarts. The **Hex 0** tag turns off this option and the **Hex 1** tag turns it on.

### Active Time

The specific lengths of time that the 7874 stays ON after the last good read can be programmed. There are four options in the Active Time parameter: no shut down, shut down after 15 minutes, shut down after 30 minutes, and shut after 60 minutes. Select these times using the **Hex 0** through **Hex 3** tags, respectively.

**Note:** NCR suggests that the Active Time parameter not be set to 0. When set to 0, the laser lights will be ON all the time which reduces the life expectancy of the laser diodes.

### 900ms Lockout Timer Restart Limit

The 900ms Lockout Timer Restart Limit parameter is OFF by default. Scan **Hex 1** to enable 900ms Lockout Timer Restart Limit. If the 900ms Lockout Timer Restart Limit is ON then the Restart Lockout Timer is also ON (refer to the “Restart Lockout Timer” section in this chapter for more information). If an item moves in (and the tag is read), out, and then back in the scan zone, the firmware recognizes the bar code as the same bar code that it has already read. In this case, the Lockout Timer is restarted only if it has been on for less than 900ms.

# Bar Codes-1

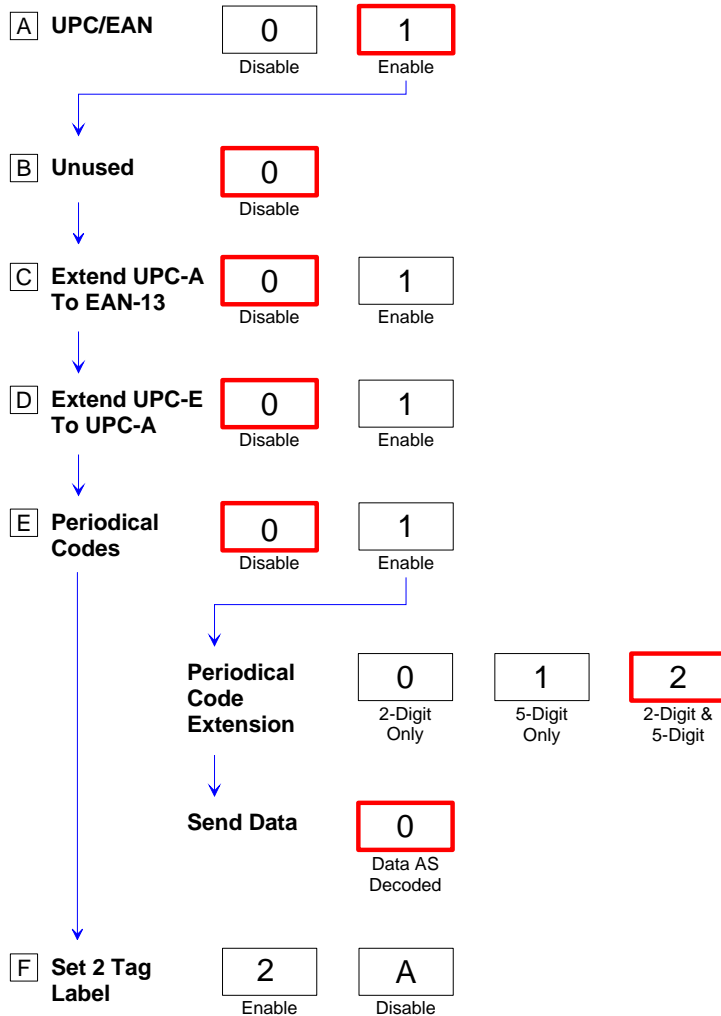
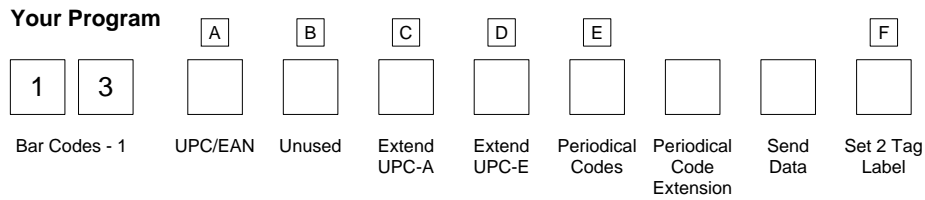

24037

The Bar Codes-1 programming mode contains programming parameters for UPC/EAN bar codes. Refer to the “Parameter Defaults” earlier in this chapter for the factory defined default value of each programming parameter.

## UPC/EAN

The UPC/EAN parameter controls reading UPC/EAN bar codes. Disable reading UPC/EAN bar codes by scanning the **Hex 0** tag and enable reading by scanning the **Hex 1** tag.

If reading UPC/EAN bar codes is disabled, there are no other entries allowed for this parameter. However, if reading UPC/EAN bar codes is enabled, the remaining parameters can be programmed.

### Extend UPC-A to EAN-13

The Extend UPC-A to EAN-13 parameter determines whether to pad the tag data, changing 12-digit UPC tags to 13-Character EAN tags. The program does this by putting a zero (0) at the front of the tag data. Scan the **Hex 0** tag to disable this option or the **Hex 1** tag to enable it.

### Extend UPC-E to UPC-A

The Extend UPC-E to UPC-A parameter determines whether to pad the tag data, changing 6-digit UPC tags to 12-digit UPC-A tags. Scan the **Hex 0** tag to disable this option or the **Hex 1** tag to enable it.

### Add-On Bar Codes

The Add-On Bar Codes parameter controls the processing of Add-On Bar Codes. Disable Add-On Bar Codes by scanning the **Hex 0** tag and enable them by scanning the **Hex 1** tag.

If Add-On Bar Codes is disabled, there are no other entries allowed for this parameter. Scanning the **Hex 0** tag also causes the scanner to go back to the Program Mode. However, if Add-On Bar Codes is enabled, the Add-On Code Length and Send Data parameters must also be programmed.

### Add-On Code Length

The Add-On Code Length parameter has three selections: 2-digit *Add-On only*, 5-digit *Add-On only*, and *either 2- or 5-digit Add-Ons*. Scan the **Hex 0** tag for 2-digit only, the **Hex 1** tag for 5-digit extension, or the **Hex 2** tag for both the 2- and 5-digit.

### Send Data

Send Data parameter has only one option: *Data As Decoded*. If the **Hex 0** tag is scanned, the data is sent as decoded, whether or not there are extension digits.

### Set 2 Tag Label

The Set 2 Tag Label parameter permits the scanner to read 2 tag specially-linked bar codes. This parameter has 2 selections: Enable and Disable. Scan **Hex 2** to enable this function or scan **Hex A** tag to disable it.

## Bar Codes-2

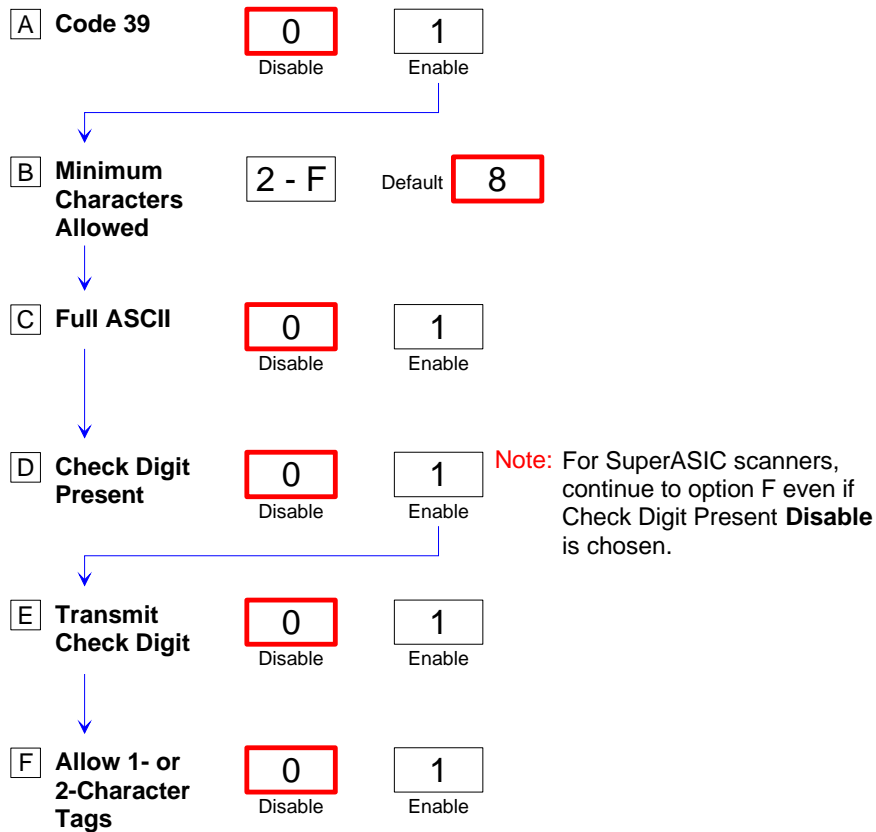
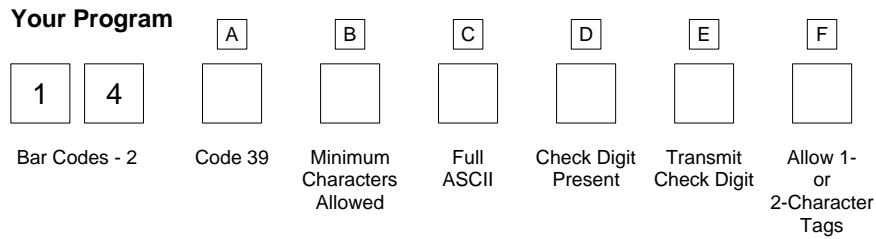

24174

The Bar Codes 2 programming mode contains programming parameters for Code 39. Refer to the “Parameter Defaults” section earlier in this chapter for the factory defined default value of each programming parameter.

### Code 39

The Code 39 parameter controls reading Code 39 (“3 of 9”) bar codes. Disable reading Code 39 bar codes by scanning the **Hex 0** tag and enable reading by scanning the **Hex 1** tag.

If reading Code 39 bar codes is disabled, there are no other entries permitted for this parameter.

### Minimum Characters

The Minimum Characters Allowed parameter defines how many characters in a bar code must be read the same by two separate scans before determining a valid read has occurred. This option should be set to the number of characters in a typical tag which ensures that the scanner reads typical tags with at least two complete good scans before sending the tag data to the host terminal.

There are 14 selections for this parameter option (2 through 15 characters). Scan the proper Hex tag (**Hex 2** through **Hex F**). The default is 8 characters.

**Note:** 10 = **Hex A**, 11 = **Hex B**, 12 = **Hex C**...

### Full ASCII

Code 39 permits full ASCII capability by encoding the additional characters. Disable this function by scanning the **Hex 0** tag, and scan the **Hex 1** tag to enable this function.

In this mode, the presence of a special character before an upper-case letter denotes that the character is lower-case.

### Check Digit Present

The Check Digit Present parameter determines if the bar code must contain a correct check digit to be identified as valid. If this function is enabled, the bar code is ignored if a check digit is not present. Scan the **Hex 0** tag to disable this option, or the **Hex 1** tag to enable it.

### Transmit Check Digit

The Transmit Check Digit parameter selects whether to send the check digit to the host terminal. Scan the **Hex 0** tag to disable this option, or the **Hex 1** tag to enable this option.

### Allow 1- or 2-Character Tags

The Allow One- or Two-Character Tags parameter selects whether or not to permit the scanner to read a 1- or 2-character Code 39 label. If the host terminal software does not require that the scanner read a 1- or 2-character Code 39 label, scan the **Hex 0** tag to disable this option. If the host terminal software requires this capability, scan the **Hex 1** tag to enable it.

### Code 39 Tone

This parameter permits you to enable or disable the Code 39 tone. Scan **Hex 0** to disable the tone (default) or **Hex 1** to enable it. If disabled, the Code 39 tone is under control of the UPC tone control (general good read tone).

### Tone Length

The Tone Length parameter permits you to set the length of the Code 39 tone. Set this parameter by scanning the appropriate Hex tag (**Hex 0 to Hex F**). Each Hex tag is incremented by 15 milliseconds. For example, **Hex 0** = 0 ms, **Hex 1** = 15 ms, **Hex 2** = 30 ms, **Hex 3** = 45 ms, and so forth. The default Code 39 Tone Length is 75 ms (**Hex 5**).

### Tone Frequency

This parameter permits you to set the frequency of the Code 39 tone. Set this parameter by scanning the appropriate Hex tag (**Hex 0 to Hex 7**).

Hex Tag	Frequency in Hertz
Hex 0	702 Hz
Hex 1	781 Hz
Hex 2	868 Hz
Hex 3	961 Hz
Hex 4	1071 Hz
Hex 5	1187 Hz
Hex 6	570 Hz
Hex 7	633 Hz

**Note:** The default Code 39 tone frequency is 1071 Hertz (**Hex 4**).

### Code 39 Halves Enable

This parameter attempts to build a Code 39 tag on the three longest tag lengths seen (tag lengths are saved in C39\_Max\_Scanned1, C39\_Max\_Scanned2, and C39\_Max\_Scanned3) as well as on any Code 39 tag length that contains a Code 39 check digit.

Code 39 Halves Enabled programming requires a *half tag* partial longer than one-half of the longest Code 39 tag ever seen by a scanner in order to prevent getting a short tag from a longer one.

### Code 39 Stitch Enable

This parameter attempts to stitch a tag to the longest tag scanned by a full strike across the whole tag. This parameter includes the Stitching Code 39 Check Digit (C39\_Stitch\_CD\_tags) option.



### Code 39 Stitch Check Digit

This parameter permits tag lengths containing a Code 39 Check Digit to be *stitched* if Code 39 Stitch Enable is active.

### Check Digit Length1 and Length2

These Check Digit lengths are programmed to permit specific length of Code 39 tag to require a Code 39 Check Digit. These can be any length in the range of 01-36 and are not required to be in the range of C39 Minimum Length and C39 Maximum Length programming.

### Scans Required

This parameter sets the number of scans required to read a Code 39 bar code. Increasing the number of scans can improve reading nominal bar codes. There are four settings: 1 scan, 2 scans, 3 scans, and 4 scans. The default is 1 scan. Set this parameter by scanning the appropriate Hex tag (**Hex 1** to **Hex 4**).

### Overlap Characters

This parameter sets the minimum number of characters which each segment must contain when tag stitching is done. There are four settings: 1 overlap character (**Hex 1**), 2 overlap characters (**Hex 2**) (default), 3 overlap characters (**Hex 3**), and 4 overlap characters (**Hex 4**). Set this parameter by scanning the appropriate Hex tag (**Hex 1** to **Hex 4**).

### Minimum Segment Size

This parameter sets the minimum number of characters which each segment must contain when tag stitching is done. Set this parameter by scanning the appropriate Hex tag (**Hex 2** to **Hex 9**). The default is **Hex 3**.

## Bar Codes–3

### Your Program

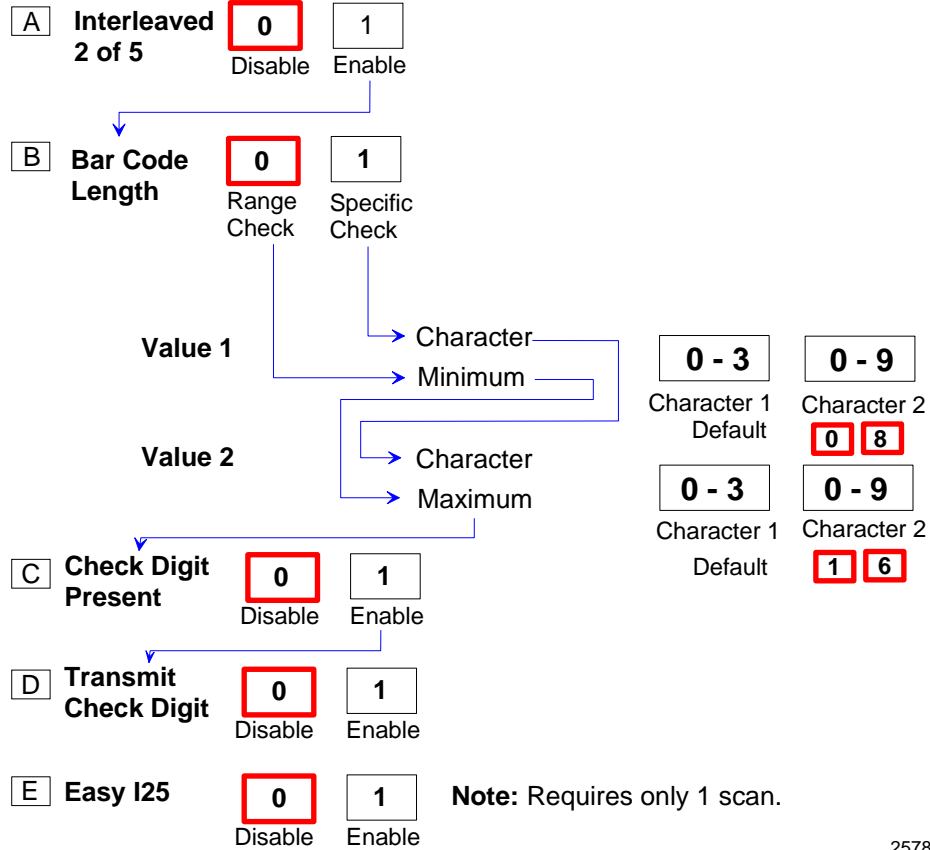
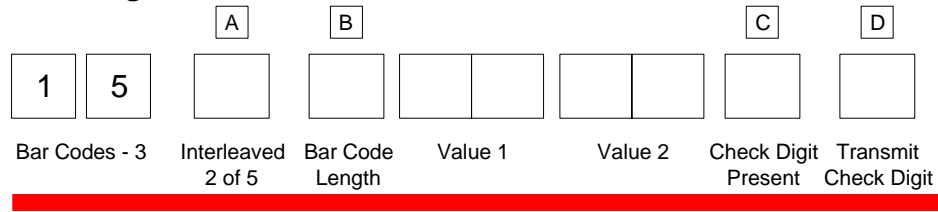

25788

The Bar Codes 3 programming mode contains programming parameters for Interleaved 2 of 5 (“ITF” or “I 2 of 5”). Refer to the “Parameter Defaults” section earlier in this chapter for the factory defined default value of each programming parameter.

### Interleaved 2 of 5

The Interleaved 2 of 5 parameter controls reading Interleaved 2 of 5 bar codes. Disable reading Interleaved 2 of 5 bar codes by scanning the **Hex 0** tag and enable reading by scanning the **Hex 1** tag.

**Note:** If reading Interleaved 2 of 5 bar codes is disabled, there are no other entries allowed for this parameter.

## Bar Code Length

The Bar Code Length parameter selects the method for determining if an Interleaved 2 of 5 bar code is a valid length. The Range Check method identifies a length range by specifying the minimum and maximum number of characters. The Specific Check method identifies two specific bar code lengths by specifying the number of characters in each. With this option, the number of characters in all Interleaved 2 of 5 bar codes must be one of the two numbers. Scan the **Hex 0** tag to use the Range Check method, scan the **Hex 1** tag to use the Specific Check method.

It is best not to use ITF if more than one length of bar code is used. The symbology has an inherent weakness where any scanner can see part of the bar code and think it is complete. The options below provide protection against this. From strongest protection to weakest protection they are:

- Specific length, same value as “Value 1” and “Value 2”
- Specific check, different values as Values 1 and 2
- Range Check

## Value 1 and 2

The Value 1 and Value 2 parameters specify the valid Interleaved 2 of 5 bar code lengths. Use these options with the Bar Code Length parameter option described in Bar Code Length. If the Range Check method is selected, Value 1 specifies the minimum number of characters in a valid Interleaved 2 of 5 bar code and Value 2 specifies the maximum number of characters. If the Specific Check method is selected, Value 1 contains one specific number of characters and Value 2 contains another.

Accepted values for Value 1 and Value 2 are 04 to 58 readable characters. The number of readable characters must be an even number; if an odd number is specified, it returns a Program Tag Error. Each value is input using two Hex tags. The first can be **Hex 0** through **Hex 5** and the second can be **Hex 0** through **Hex 9**.

## Check Digit Present

The Check Digit Present parameter determines if the bar code must contain a correct check digit to be identified as valid. If this function is enabled, the bar code is ignored if a check digit is not present. Scan the **Hex 0** tag to disable this option, or the **Hex 1** tag to enable it.

## Transmit Check Digit

The Transmit Check Digit parameter selects whether to send the check digit to the host terminal. Scan the **Hex 0** tag to disable this option, or the **Hex 1** tag to enable it.

### Interleaved 2 of 5 Tone

This parameter permits you to enable or disable the Interleaved 2 of 5 tone. Scan **Hex 0** to disable the tone (default) or **Hex 1** to enable it. If disabled, the Interleaved 2 of 5 tone is under control of the UPC tone control (general good read tone).

### Tone Length

The Tone Length parameter permits you to set the length of the Interleaved 2 of 5 tone. Set this parameter by scanning the appropriate Hex tag (**Hex 0 to Hex F**). Each Hex tag is incremented by 15 milliseconds. For example, **Hex 0** = 0 ms, **Hex 1** = 15 ms, **Hex 2** = 30 ms, **Hex 3** = 45 ms, and so forth. The default Interleaved 2 of 5 Tone Length is 75 ms (**Hex 5**).

### Tone Frequency

This parameter permits you to set the frequency of the Interleaved 2 of 5 tone. Set this parameter by scanning the appropriate Hex tag (**Hex 0 to Hex 7**).

Hex Tag	Frequency in Hertz
Hex 0	702 Hz
Hex 1	781 Hz
Hex 2	868 Hz
Hex 3	961 Hz
Hex 4	1071 Hz
Hex 5	1187 Hz
Hex 6	570 Hz
Hex 7	633 Hz

**Note:** The default Interleaved 2 of 5 tone frequency is 1071 Hertz (**Hex 4**).

### Interleaved 2 of 5 Check Digit Length1

Interleaved 2 of 5 Check Digit Length1 sets the number of data characters defining the tag length1 that requires a Check Digit. This tag length could be outside the normal *specific length* or *range* of tag lengths programming for Interleaved 2 of 5. This parameter permits Interleaved 2 of 5 tags of a certain length to have a Check Digit while other Interleaved 2 of 5 tag lengths may not require a Check Digit.

### Interleaved 2 of 5 Check Digit Length2

Interleaved 2 of 5 Check Digit Length2 sets the number of data characters defining the tag length2 that requires a Check Digit. This tag length could be outside the normal *specific length* or *range* of tag lengths programming for Interleaved 2 of 5.

### Enable Interleaved 2 of 5 Stitching

This parameter is only valid if the Interleaved 2 of 5 Specific Length is programmed as active. Scanning **Hex C** enables Interleaved 2 of 5 tag stitching. It is recommended that stitching be enabled only if one tag Interleaved 2 of 5 length is programmed. Scanning **Hex D** disables Interleaved 2 of 5 Tag Stitching.

### Scans Required

This parameter sets the number of scans required to read an Interleaved 2 of 5 bar code. Increasing the number of scans can improve reading nominal bar codes. There are four settings: 1 scan, 2 scans, 3 scans, and 4 scans. The default is 2 scans. Set this parameter by scanning the appropriate Hex tag (**Hex 1 to Hex 4**).

### Overlap Characters

This parameter sets the minimum number of characters which each segment must contain when tag stitching is done. There are four settings: 1 overlap character (**Hex 1**) (default), 2 overlap characters (**Hex 2**), 3 overlap characters (**Hex 3**), and 4 overlap characters (**Hex 4**). Set this parameter by scanning the appropriate Hex tag (**Hex 1 to Hex 4**).

### Minimum Segment Size

This parameter sets the minimum number of characters which each segment must contain when tag stitching is done. Set this parameter by scanning the appropriate Hex tag (**Hex 2 to Hex 9**). The default is **Hex 3**.

## Bar Codes-4

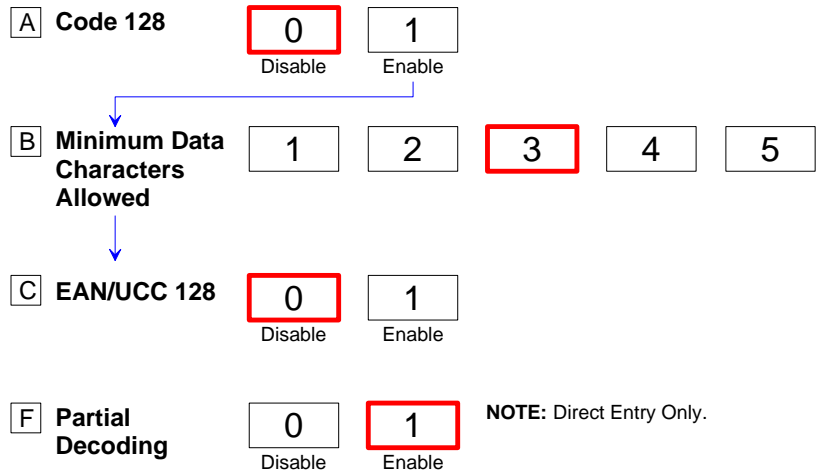
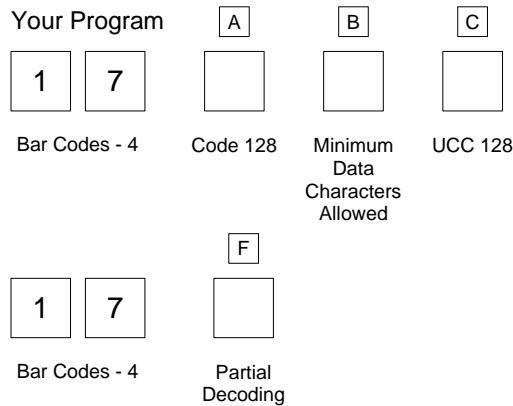

The Bar Codes 4 programming mode contains programming parameters for Code 128 bar codes. Refer to the “Parameter Defaults” section earlier in this chapter for the factory defined default value of each programming parameter.

### Code 128

The Code 128 parameter contains two selections: Disable and Enable. Disable reading Code 128 bar codes by scanning the **Hex 0** tag and enable reading by scanning the **Hex 1** tag.

### Code 128 Tone

This parameter permits you to enable or disable the Code 128 tone. Scan **Hex 0** to disable the tone (default) or **Hex 1** to enable it. If disabled, the Code 128 tone is under control of the UPC tone control (general good read tone).

## Tone Length

The Tone Length parameter permits you to set the length of the Code 128 tone. Set this parameter by scanning the appropriate Hex tag (**Hex 0 to Hex F**). Each Hex tag is incremented by 15 milliseconds. For example, **Hex 0** = 0 ms, **Hex 1** = 15 ms, **Hex 2** = 30 ms, **Hex 3** = 45 ms, and so forth. The default Code 128 Tone Length is 75 ms (**Hex 5**).

## Tone Frequency

This parameter permits you to set the frequency of the Code 128 tone. Set this parameter by scanning the appropriate Hex tag (**Hex 0 to Hex 7**).

Hex Tag	Frequency in Hertz
Hex 0	702 Hz
Hex 1	781 Hz
Hex 2	868 Hz
Hex 3	961 Hz
Hex 4	1071 Hz
Hex 5	1187 Hz
Hex 6	570 Hz
Hex 7	633 Hz

**Note:** The default Code 128 tone frequency is 1071 Hertz (**Hex 4**).

## Code 128 Stitch Enable

This parameter determines whether Code 128 tag stitching is enabled or disabled. Scan the **Hex C** to disable Code 128 Stitching (default) or **Hex D** to enable it.

## Scans Required

This parameter sets the number of scans required to read a Code 128 bar code. Increasing the number of scans can improve reading nominal bar codes. There are four settings: 1 scan, 2 scans, 3 scans, and 4 scans. The default is 1 scan. Set this parameter by scanning the appropriate Hex tag (**Hex 1 to Hex 4**).

## Overlap Characters

This parameter sets the minimum number of characters which each segment must contain when tag stitching is done. There are four settings: 1 overlap character (**Hex 1**), 2 overlap characters (**Hex 2**) (default), 3 overlap characters (**Hex 3**), and 4 overlap characters (**Hex 4**). Set this parameter by scanning the appropriate Hex tag (**Hex 1 to Hex 4**).

### Minimum Segment Size

This parameter sets the minimum number of characters which each segment must contain when tag stitching is done. Set this parameter by scanning the appropriate Hex tag (**Hex 2 to Hex 9**). The default is **Hex 4**.

## Bar Codes-5

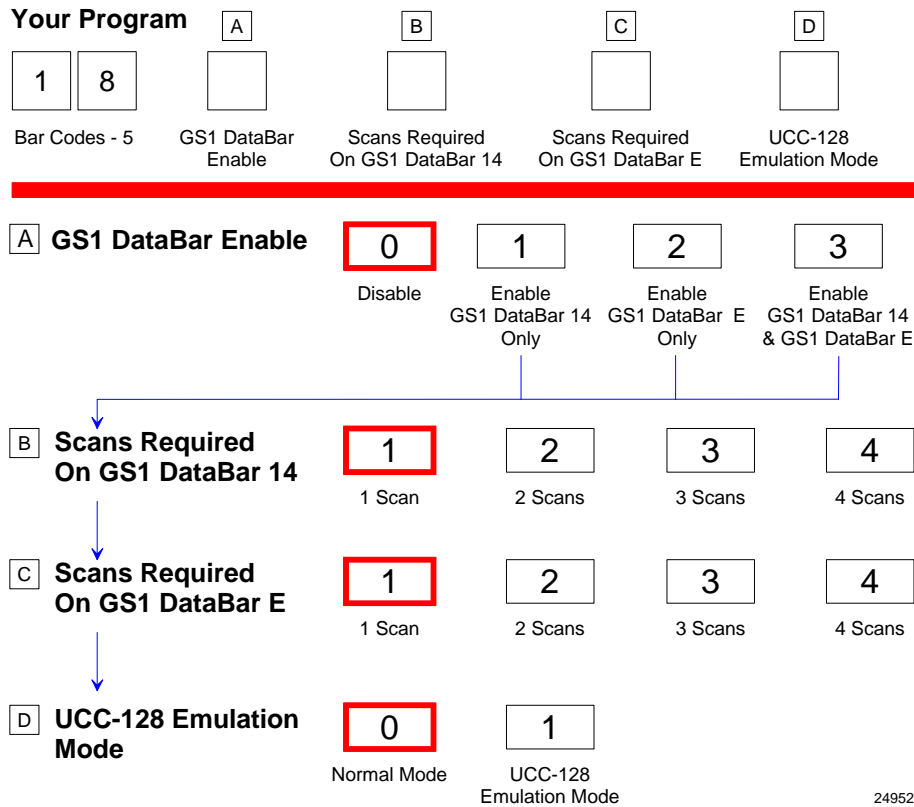

The Bar Codes 5 programming mode contains programming parameters for GS1 DataBar bar codes. Refer to the “Parameter Defaults” section earlier in this chapter for the factory defined default value of each programming parameter.

### GS1 DataBar Enable

This parameter contains 4 selections. Disable reading GS1 DataBar bar codes by scanning the **Hex 0** programming tag.

- Reading either or both GS1 DataBar-14 and GS1 DataBar-E bar codes is enabled with this parameter.
- Read GS1 DataBar-14 only—Scan the **Hex 1** programming tag
- Read GS1 DataBar-E only—Scan the **Hex 2** programming tag
- Read both GS1 DataBar-14 and GS1 DataBar-E—Scan the **Hex 3** programming tag



### Scans Required on GS1 DataBar-14

This parameter sets the number of scans required to read a GS1 DataBar-14 bar code. Increasing the number of scans can improve reading nominal bar codes. There are four settings: 1 scan, 2 scans, 3 scans, and 4 scans. Set this parameter by scanning the appropriate programming tag, **Hex 1** through **Hex 4**.

### Scans Required on GS1 DataBar-E

This parameter sets the number of scans required to read a GS1 DataBar-E bar code. Increasing the number of scans can improve reading nominal bar codes. There are four settings: 1 scan, 2 scans, 3 scans, and 4 scans. Set this parameter by scanning the appropriate programming tag, **Hex 1** through **Hex 4**.

### UCC-128 Emulation Mode

The UCC-128 Emulation Mode refers to the Uniform Code Council Code 128 Data Formatted Start Code. Two choices are available for this parameter. Scan the **Hex 0** programming tag for normal mode or the **Hex 1** programming tag to enable UCC-128 Emulation.

## Bar Codes–6

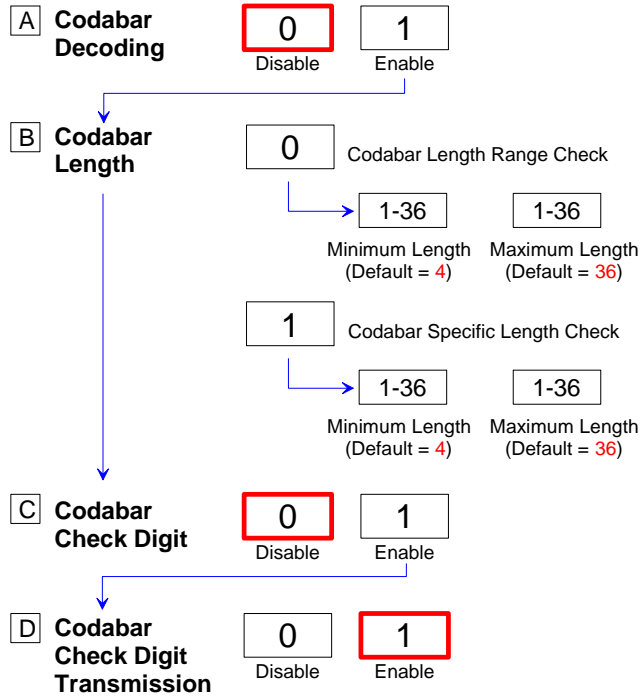
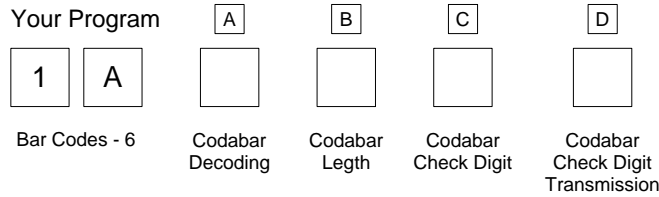

25515

The Bar Codes 6 programming mode contains programming parameters for Codabar bar codes. Refer to the “Parameter Defaults” section earlier in this chapter for the factory defined default value of each programming parameter.

### Codabar Check Digit

The Codabar Check Digit parameter permits control of Codabar check digit requirement. Scan the appropriate Hex tag (Hex 1 to Hex 0) to enable or disable the check digit. The default is Hex 0—Disable Codabar check digit.

### Codabar Check Digit Transmission

The Codabar Check Digit Transmission parameter selects whether to send the check digit to the host terminal. Scan the **Hex 0** tag to disable this option, or the **Hex 1** tag to enable this option.

### Codabar Tone Length

The Codabar Tone Length parameter permits you to set the length of the Codabar tone. Set this parameter by scanning the appropriate Hex tag (**Hex 0 to Hex F**). Each Hex tag is incremented by 15 milliseconds. For example, **Hex 0** = 0 ms, **Hex 1** = 15 ms, **Hex 2** = 30 ms, **Hex 3** = 45 ms, and so forth. The default Codabar Tone Length is 75 ms (**Hex 5**).

### Codabar Tone Frequency

This parameter permits you to set the frequency of the Interleaved 2 of 5 tone. Set this parameter by scanning the appropriate Hex tag (**Hex 0 to Hex 7**).

Hex Tag	Frequency in Hertz
Hex 0	702 Hz
Hex 1	781 Hz
Hex 2	868 Hz
Hex 3	961 Hz
Hex 4	1071 Hz
Hex 5	1187 Hz
Hex 6	570 Hz
Hex 7	633 Hz

**Note:** The default Codabar tone frequency is 1071 Hertz (**Hex 4**).

### Codabar Tone

This parameter permits you to enable or disable the Codabar tone. Scan **Hex 0** to disable the tone (default) or **Hex 1** to enable it. If disabled, the Codabar tone is under control of the UPC tone control (general good read tone).

### Codabar Halves

This parameter attempts to build a Codabar tag on the longest tag length seen. Codabar Halves Enabled programming requires a *half tag* partial longer than one-half of the longest Codabar tag ever seen by a scanner in order to prevent getting a short tag from a longer one.

Scan the **Hex 2** tag to disable this option, or the **Hex 3** tag to enable this option

### Codabar Stitch

This parameter attempts to stitch a tag to the longest tag scanned by a full strike across the whole tag. Scan the Hex 4 tag to disable this option, or the Hex 5 tag to enable this option.

### Number of Codabar Scans Required

This parameter sets the number of scans required to read a Codabar bar code. Increasing the number of scans can improve reading nominal bar codes. There are four settings: 1 scan, 2 scans, 3 scans, and 4 scans. The default is 1 scan. Set this parameter by scanning the appropriate Hex tag (**Hex 1 to Hex 4**).

## Bar Codes-7

Your Program

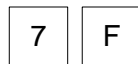

Bar Codes - 7

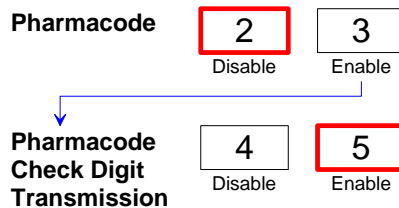

25516

The Bar Codes 7 programming mode contains programming parameters for Pharmacode bar codes. Refer to the “Parameter Defaults” section earlier in this chapter for the factory defined default value of each programming parameter.

### Pharmacode Check Digit Transmission

The Pharmacode Check Digit Transmission parameter selects whether to send the check digit to the host terminal. Scan the **Hex 0** tag to disable this option, or the **Hex 1** tag to enable this option.

# Label Identifiers

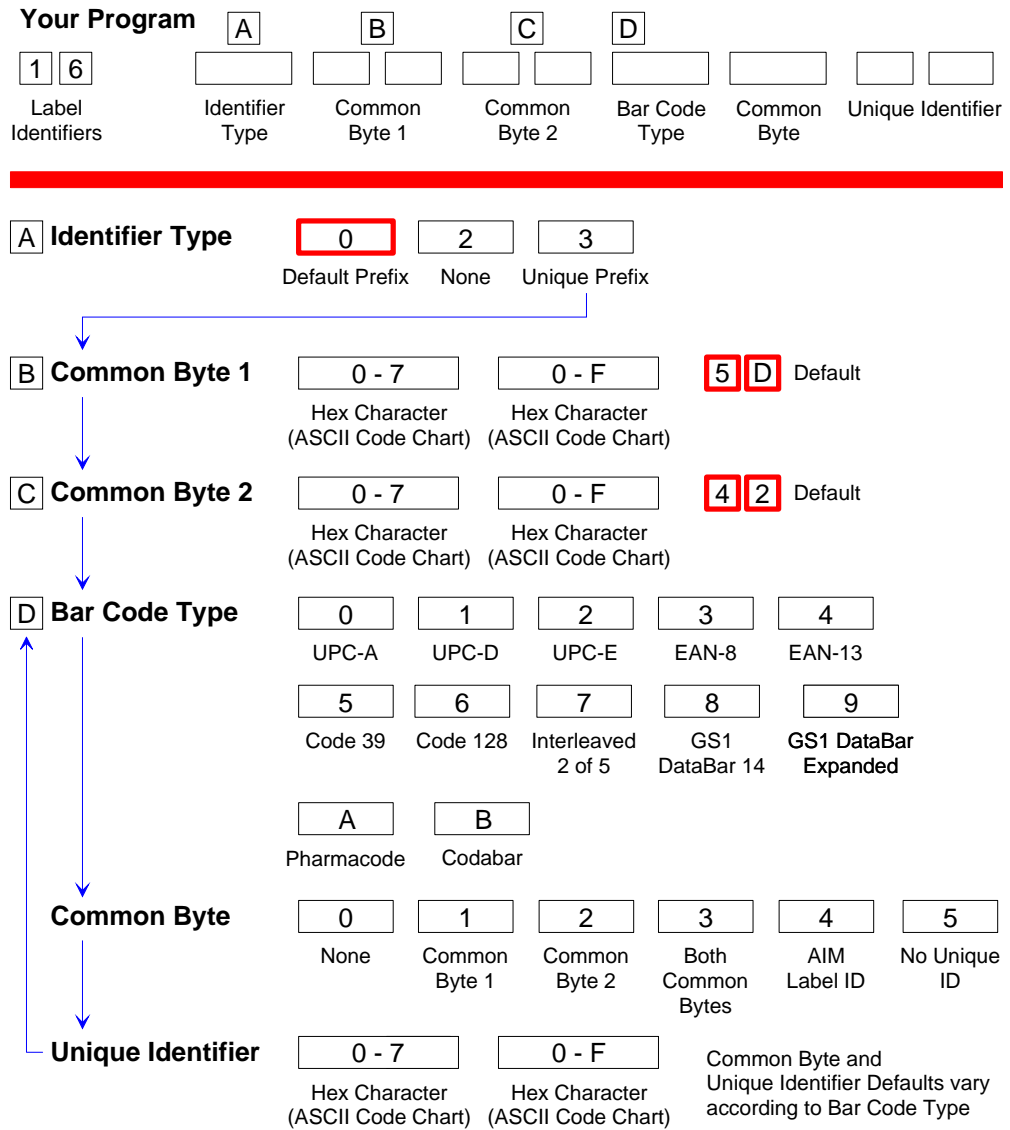

25514

The Label Identifiers programming mode selects the parameters for adding label identifiers to communication messages. These identifiers apply to the NCR USB and RS232 communication protocols. Label identifiers for the other modes of communication are determined by the firmware and are not programmable.

## Identifier Type

The Identifier Type parameter defines the type and placement of label identifiers. Default identifiers that prefix the message data, unique prefix identifiers, or no identifiers can be selected.

Select the Identifier Type parameter by scanning the appropriate tag (**Hex 0**, **Hex 2**, or **Hex 3**). If default identifiers are selected, do not enter any other parameter in this programming mode.

*Default Prefix*

Scan the **Hex 0** tag to use the default prefix. The default label identifiers vary depending on the type of bar code read. Following are the default identifiers for each bar code type:

Bar Code Type	Hex	ASCII
UPC-A	41H	A
UPC-E	45H	E
EAN-8	46H 46H	FF
EAN-13	46H	F
Code 39	42H 31H	B1
Interleaved 2 of 5	42H 32H	B2
Code 128	42H 33H	B3
GS1 DataBar-14	5DH 65H 30H	je0
GS1 DataBar-Expanded	5DH 65H 30H	je0
Pharmacode	41H	A
Codabar	4EH	N

25577

Scan the **Hex 2** tag to select none. No label identifiers are added to the message data.

*Unique Prefix*

To use a unique prefix, scan the **Hex 3** tag. A Unique Identifier is associated with each bar code type. Also, one, two, or no Common Bytes may be used. The following figure shows the possible message formats when using a unique prefix. The formats do not show other elements programmed in the other RS232 programming modes.

**Unique Label Identifiers**

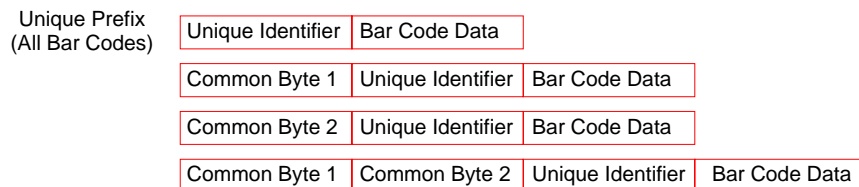

22769

**Common Byte 1 and Common Byte 2**

The Common Byte 1 and Common Byte 2 parameters permit the specification of the data sent to the host terminal in the Common Byte fields. Enter this information as two (2) Hex characters for each Common Byte.

**Note:** Refer to the ASCII Code Chart for the Hex Characters; however, values of 20 to 7E are recommended. Do not use the same characters as the Terminator Byte or the message may terminate too soon. Also, a Common Byte cannot be 00.

If not using a Common Byte, scan any Hex tag twice except **Hex 0** or the Terminator Byte value.

**Note:** Four (4) tags must be scanned to go to the next parameter.

### Bar Code Type

The Bar Code Type parameter selects the bar code type for entering its associated label identifier information. After entering a Bar Code Type, enter the Common Byte and Unique Identifier. This procedure repeats until the label identifiers are specified for each bar code type. Scan the **Hex 0** through **Hex 9** tag to enter the appropriate Bar Code Type.

**Note:** UPC Version D is always disabled.

### Common Byte

The Common Byte parameter selects which common bytes, if any, to add to the bar code data message. Each entry is unique to the previously specified Bar Code Type. Scan the **Hex 0** tag for no Common Bytes, the **Hex 1** tag for Common Byte 1, the **Hex 2** tag for Common Byte 2, the **Hex 3** tag for both Common Bytes, or the **Hex 4** tag for AIM ID on GS1 DataBar.

### Unique Identifier

The Unique Identifier parameter permits the specification of the data sent to the host terminal in the Unique Identifier field. Each entry is unique to the previously specified Bar Code Type. Enter this data as two (2) Hex characters using recommended values of 20 to 7E (Refer to the "ASCII Code Chart" section in chapter 5).

**Note:** If the same characters are used as in the Terminator Byte, the message may terminate too soon.

## RS232 Parameters 1

**Your Program**

	A	B	C	D
2				
0				
RS-232 Parameters - 1	Baud Rate	Parity	Stop Bits And Character Length	Handshake

---

**A Baud Rate**

0	1	2	3	4	5	6
300	600	1200	2400	4800	9600	19200

**B Parity**

0	1	4
Odd	Even	None

**C Stop Bits And Character Length**

0	1	2	3
1 Stop Bit 7-Bit Character	1 Stop Bit 8-Bit Character	2 Stop Bits 7-Bit Character	2 Stop Bits 8-Bit Character

**D Handshake**

0	1	2	3	4	5
RTS Low Ignore CTS	RTS High Ignore CTS	Raise RTS Wait For CTS	Raise RTS Ignore CTS	RTS Low Wait For CTS	RTS High Wait For CTS

22772

The RS232 Parameters 1 programming mode contains four of the parameters required for RS232 communications. From this programming mode the Baud Rate, Parity, Stop Bits and Character Length, and Handshake Options can be selected. Refer to the “Parameter Defaults” section earlier in this chapter for the factory defined default value of each programming parameter.

### Baud Rate

The Baud Rate parameter contains seven selections: 300 Baud, 600 Baud, 1200 Baud, 2400 Baud, 4800 Baud, 9600 Baud, and 19200 Baud. Scan the appropriate **Hex 0** through **Hex 6** tag to set the desired Baud rate.

### Parity

The Parity parameter contains three selections: Odd, Even, and None. For 7-bit characters, bit 8 is the parity bit; for 8-bit characters, bit 9 is the parity bit. Choosing no parity and 7-bit character length causes the scanner to send two (2) stop bits; the scanner must also receive two (2) stop bits. Scan the appropriate **Hex 0**, **Hex 1**, or **Hex 4** tags to select the desired Parity.



## Stop Bits and Character Length

The Stop Bits and Character Length parameter contains four selections: 1 Stop Bit and 7-bit Character Length, 1 Stop Bit and 8-bit Character Length, 2 Stop Bits and 7-bit Character Length, and 2 Stop Bits and 8-bit Character Length. Choosing no parity and 7-bit Character Length causes the 7874 to send two (2) stop bits; the scanner must also receive two (2) stop bits. If 8-bit Character length and parity is selected, only one (1) stop bit is sent. Scan the appropriate **Hex 0** through **Hex 3** tag to set the Stop Bits and Character Length.

## Handshake

The Handshake parameter contains six selections. When considering these, note that the scanner controls only RTS; however, it can monitor CTS. The following list identifies each Handshake option.

- RTS is always low, CTS is ignored (**Hex 0** tag).
- RTS is always high, CTS is ignored (**Hex 1** tag).
- Scanner raises RTS and waits for CTS to go high before transmitting (**Hex 2** tag).
- Scanner raises RTS before transmitting and ignores the state of CTS (**Hex 3** tag).
- RTS is always low and scanner waits for CTS to go high before transmitting (**Hex 4** tag).
- RTS is always high and scanner waits for CTS to go high before transmitting (**Hex 5** tag).

Scan the appropriate **Hex 0** through **Hex 5** tag to set the Handshake option.

## RS232 Parameters 2

**Your Program**

2	1	A	B	C
RS-232 Parameters - 2	BCC Options	Interface Control	Check Digit	

---

**A BCC Options**

0	1
Disable	Enable

**B Interface Control**

0	1	2	3
None	ACK/NAK	XOn/XOff	ACK/NAK & XOn/XOff

**C Check Digit**

0	1	2	3
Disable UPC-A Disable EAN-8 Disable EAN-13 Disable UPC-E	Enable UPC-A Enable EAN-8 Enable EAN-13 Disable UPC-E	Disable UPC-A Disable EAN-8 Disable EAN-13 Enable UPC-E	Enable UPC-A Enable EAN-8 Enable EAN-13 Enable UPC-E
4	5	6	7
Disable UPC-A Disable EAN-8 Enable EAN-13 Disable UPC-E	Disable UPC-A Disable EAN-8 Enable EAN-13 Enable UPC-E	Disable UPC-A Enable EAN-8 Disable EAN-13 Disable UPC-E	Disable UPC-A Enable EAN-8 Disable EAN-13 Enable UPC-E
8	9	A	B
Disable UPC-A Enable EAN-8 Enable EAN-13 Disable UPC-E	Disable UPC-A Enable EAN-8 Enable EAN-13 Enable UPC-E	Enable UPC-A Disable EAN-8 Disable EAN-13 Disable UPC-E	Enable UPC-A Disable EAN-8 Disable EAN-13 Enable UPC-E
C	D	E	F
Enable UPC-A Disable EAN-8 Enable EAN-13 Disable UPC-E	Enable UPC-A Disable EAN-8 Enable EAN-13 Enable UPC-E	Enable UPC-A Enable EAN-8 Disable EAN-13 Disable UPC-E	Enable UPC-A Enable EAN-8 Disable EAN-13 Enable UPC-E

24041

The RS232 Parameters 2 programming mode contains some of the parameters required for RS232 communications. From this mode BCC Options, Interface Control, and Check Digit can be selected. Refer to the “Parameter Defaults” section earlier in this chapter for the factory defined default value of each programming parameter.

### BCC Options

The BCC Option parameter permits the use of BCC at the end of a message to be enabled or disabled. When enabled, the BCC is the last character sent and is the Exclusive OR of each byte sent prior to the BCC, except the prefix byte. Scan the **Hex 0** tag to disable the BCC Option, or scan the **Hex 1** tag to enable it.

## Interface Control

The Interface Control parameter permits control of the transfer of data between the scanner and the host terminal. The options are None, enable ACK/NAK, enable XOn/XOff, and enable both ACK/NAK and XOn/XOff.

If enable ACK/NAK is selected, each message sent to the host terminal must be acknowledged before sending the next message. Receiving the message properly causes an ACK to be sent, and if there are any errors, a NAK is sent instead and the scanner sends the message again. Also, any valid message other than NAK or XOn/XOff, if enabled, serves as an ACK as long as the message from the scanner is completed before the host terminal starts sending the valid message to the scanner.

An XOff message turns the scanner transmitter off until the scanner receives an XOn message. An XOn message can be received at any time. If the scanner is sending a message when it receives an XOff, since these messages can be received any time, data transmission stops after sending the current byte. When the scanner receives the next XOn, it sends the remainder of the message. The scanner does not acknowledge XOff and XOn messages with ACK or NAK messages.

Select the interface by scanning the appropriate **Hex 0** through **Hex 5** tag.

## Check Digit

The Check Digit parameter permits control of the transmission of UPC-A, UPC-E, EAN-8, and EAN-13 check digits. Scan the appropriate Hex tag (**Hex 0** to **Hex F**) to independently enable or disable UPC-A, UPC-E, EAN-8, and EAN-13 check digits. The default is **Hex 1**—Enable UPC-A, EAN-8, and EAN-13; Disable UPC-E.

## RS232 Prefix Byte

**Your Program**

		<b>A</b>	<b>B</b>
<input type="text" value="2"/>	<input type="text" value="2"/>	<input type="text"/>	<input type="text"/>
RS-232 Prefix Byte	Prefix Byte	ASCII Code	

---

**A Prefix Byte**

<input type="text" value="0"/>	<input type="text" value="1"/>
Disable	Enable

**B ASCII Code**

<input type="text" value="0 - 7"/>	<input type="text" value="0 - F"/>	<input type="text" value="0 2"/> Default
Hex Character (ASCII Code Chart)	Hex Character (ASCII Code Chart)	

The RS232 Prefix Byte programming mode controls the use of prefix bytes. If an RS232 Prefix Byte is used, it is the leading character in each message sent to the host terminal. Following it is the message data. Refer to the “Parameter Defaults” section earlier in this chapter for the factory defined default value of each programming parameter.

### Prefix Byte

The Prefix Byte parameter contains two selections: Disable and Enable. Scan the **Hex 0** tag to disable the Prefix Byte, or the **Hex 1** tag to enable it.

### ASCII Code

The ASCII Code parameter permits the specification of what ASCII code to use for the Prefix Byte. Enter the selection by scanning the appropriate two Hex tags (shown in the *ASCII Code Chart* in *Programming* chapter). Any value from 01 through 0F can be selected; however, the recommendation is to use the Start Of Text (STX) ASCII Code which is 02 Hex. Scan the two appropriate Hex tags (**Hex 0** through **Hex 7** for the first character and **Hex 0** through **Hex F** for the second).

**Note:** ASCII Code parameter for the RS232 Terminator Byte has the same function.

## RS232 Terminator Byte

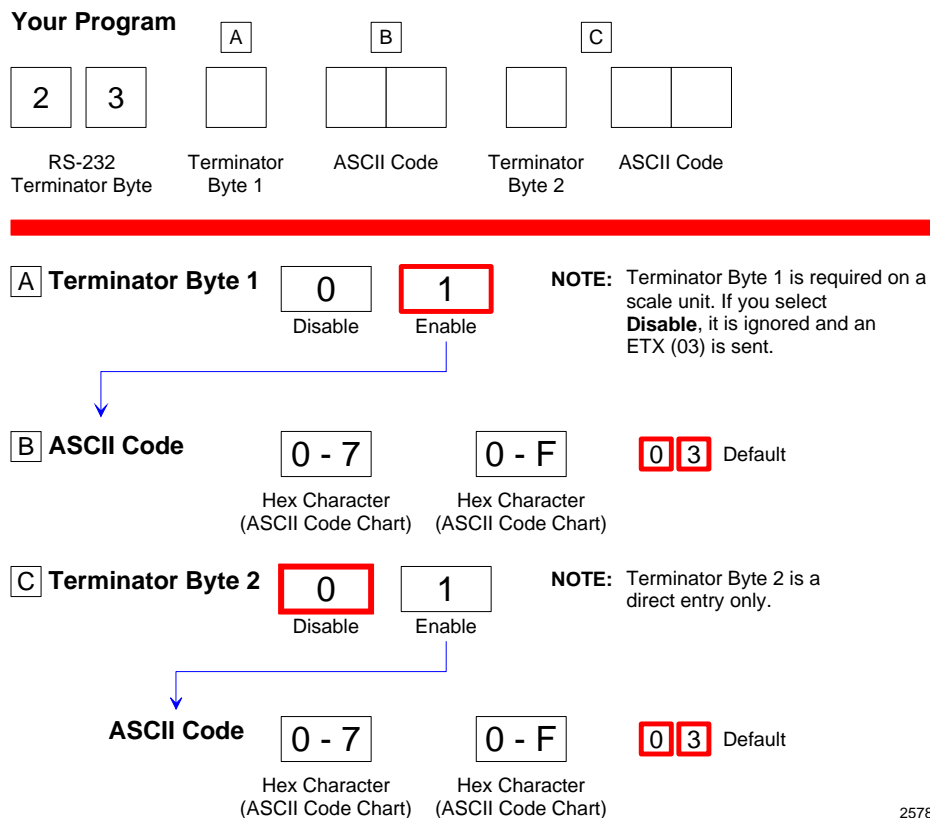

The RS232 Terminator Byte programming mode controls the use of terminator bytes. If an RS232 Terminator Byte is used, it goes at the end of the message sent to the host terminal. If a BCC is included, it follows the Terminator Byte and includes the Terminator Byte in the calculation. Refer to the “Parameter Defaults” section earlier in this chapter for the factory defined default value of each programming parameter.

### Terminator Byte

There are two RS232 Terminator Bytes available—the second Terminator Byte being a direct entry only. Therefore after programming the First Terminator Byte **Hex 2**, **Hex 3** and **Hex C** must be scanned to be able to program the Second Terminator Byte.

### ASCII Code

The ASCII Code parameter for RS232 Terminator Byte and Prefix Byte has the same function. Refer to the “RS232 Prefix Byte” section of this chapter for more information.

## RS232 Communications Options

### Your Program

<input type="text" value="2"/>	<input type="text" value="4"/>	<input type="text"/>	<input type="text"/>	<input type="text"/>
Communication Options	RS-232 Delay	Scanner or Scanner / Scale Format	Good Weigh Tone	

---

RS-232 Delay	<input type="text" value="0"/>	<input type="text" value="1"/>	<input type="text" value="2"/>
	No Delay	10 Milliseconds	50 Milliseconds

Scanner or Scanner / Scale Format	<input type="text" value="4"/>	<input type="text" value="5"/>
	Scanner Only	Scanner / Scale

Good Weigh Tone	<input type="text" value="8"/>	<input type="text" value="9"/>
	Disable	Enable

22779

The RS232 Communications Options parameters control the delay between messages, and the format in which the scanner and host terminal exchange tag data messages. The firmware is programmed to accept one parameter at a time and then leave this programming mode. Therefore, each of the parameters must be programmed separately. Refer to the “Parameter Defaults” section earlier in this chapter for the factory defined default value of each programming parameter.

## Message Delay

The Message Delay option sets the minimum time the firmware waits before sending the next message. This permits lowering CTS by the host terminal to inhibit data from the scanner. This option was not available on previous scanners.

Messages can be delayed as follows:

- **Hex 0** for no delay
- **Hex 1** for a 10 ms delay
- **Hex 2** for a 50 ms delay

## Scanner/Scale Format

The Scanner or Scanner/Scale Format option permits forcing the data format to either scanner only format or scanner/scale format to accommodate the host terminal. In some circumstances a host terminal may not be able to handle the normal format sent to it. In that case, selecting one of these options permits the use of the other format.

The choices for this option are as follows:

- **Hex 4** for Scanner only format
- **Hex 5** for Scanner/Scale format

The normal (default) format for scanner only tag data messages is as follows:

- Scanner-Only Tag Data
- Message Format

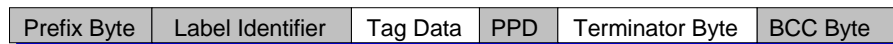

Shading indicates optional information.

16564

The normal (default) format for scanner/scale tag data messages is as follows:

- Scanner/Scale Tag Data
- Message Format

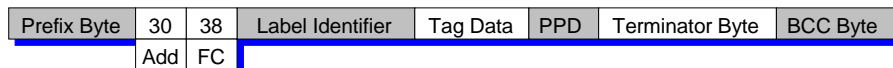

Shading indicates optional information.

16565

The difference between the scanner only and the scanner/scale format is that the scanner/scale format has an address and a function code following the optional Prefix Byte. For more detailed information on message formats refer to the *NCR Scanner/Scale Interface Programmer's Guide (BD20-1074-A)*.

## Normal or Eavesdrop Mode

The normal mode is used for most RS232 connections. Eavesdrop mode is also available to permit another device to monitor the communications between the 7874 and the host terminal. Scan the **Hex 6** tag to select the normal mode or the **Hex 7** tag to select the eavesdrop mode.

## Good Weigh Tone

The 7874 can be programmed to sound a tone following a successful item weigh function. Scan the **Hex 8** tag to disable this function and the **Hex 9** tag to enable it.

## Scale Parameters

### Your Program

<div style="border: 1px solid black; padding: 2px; display: inline-block; width: 30px; text-align: center;">3</div> <div style="border: 1px solid black; padding: 2px; display: inline-block; width: 30px; text-align: center;">0</div> <div style="border: 1px solid black; padding: 2px; display: inline-block; width: 30px; text-align: center;"> </div> <div style="border: 1px solid black; padding: 2px; display: inline-block; width: 30px; text-align: center;"> </div>	Scale Parameters	Model	IBM Address
<b>Model</b>	<div style="border: 1px solid black; padding: 2px; display: inline-block; width: 30px; text-align: center;">3</div>	<div style="border: 1px solid black; padding: 2px; display: inline-block; width: 30px; text-align: center;">4</div>	
	Scanner/Scale	Scanner Only	
<b>IBM address</b>	<div style="border: 1px solid black; padding: 2px; display: inline-block; width: 30px; text-align: center;">5</div>	<div style="border: 1px solid black; padding: 2px; display: inline-block; width: 30px; text-align: center;">6</div>	<div style="border: 2px solid red; padding: 2px; display: inline-block; width: 30px; text-align: center;">7</div>
	Address 6A	Address 6B	Address 6E
			22818

The Scale Parameters programming mode controls specific parameters associated with a 7874 that has a scale. This mode can be used to identify if the 7874 includes a scale and to define the address if the scale is connected to an Host terminal. Refer to the “Parameter Defaults” section earlier in this chapter for the factory defined default value of each programming parameter.

### Model

The Model parameter specifies if the 7874 is a Scanner/Scale or a Scanner only. This parameter is set at the factory and should not need changing under normal circumstances. Scan the **Hex 3** tag to specify that the unit is a Scanner/Scale, or scan the **Hex 4** tag to specify that the unit is a Scanner only. If the scale is disabled on a Scanner/Scale unit by scanning the **Hex 4** tag, the BCC option also changes to the appropriate state.

## IBM Address

When programming a 7874 for IBM communications, the proper scale communications address must be selected. Selecting the IBM 468x communications protocol sets the scale address to 6E; however, it may need to be changed to 6A or 6B, depending on the IBM configuration in the particular IBM host terminal software. Scan the **Hex 5** tag for address 6A, the **Hex 6** tag for address 6B, or the **Hex 7** tag for address 6E.

The IBM host terminal integrated scanner/scale driver normally uses address 6E. However, if the scanner works but the scale does not, try using the other two scale addresses.

## Miscellaneous Parameters

### Your Program

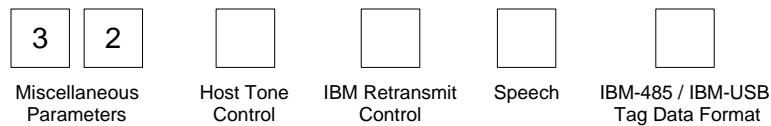

### Host Tone Control



### IBM Retransmit Control



### Speech



### IBM-485 / IBM-USB Tag Data Format



22813

The Miscellaneous Parameters programming mode controls parameters associated with the 7874 that do not fit easily into any of the other categories. The 7874 firmware is programmed to accept one parameter at a time and then leave this programming mode. Therefore, each of the parameters must be programmed separately. Refer to the “Parameter Defaults” section earlier in this chapter for the factory defined default value of each programming parameter.

### Host Tone Control

When a host terminal is used, this parameter determines what device controls the tone. Scanning the **Hex 4** tag enables this option and the host terminal controls the tone. Scanning the **Hex 3** tag disables this option.



## IBM Retransmit Control

When an IBM host terminal is used and the scale detects a bad message from the host terminal, this parameter controls how the original message gets retransmitted. If enable is selected by scanning the **Hex 7** tag, the scale retransmits the original message three (3) times, and then terminates the sequence. If forever is selected by scanning the **Hex 8** tag, the scale retransmits the original message until it is accepted, or until the scale is told to reset by the host terminal. Do not use the enable selection unless advised to do so by NCR to solve a problem.

## Enable/Disable Voice Messages

The 7874 uses voice messages for diagnostics, and clerk messages. If voice messages are enabled, the messages are heard at the appropriate time; if they are disabled, the beep tones are heard instead. To enable or disable voice messages, scan the following sequence of programming tags. These tags must be the first tags scanned after applying power to the unit.

### *All Voice Messages Off/On*

- Program Mode
- Hex 3
- Hex 2
- Hex D
- Save and Reset

### *Clerk Messages On*

- Program Mode
- Hex 3
- Hex 3
- Hex 1
- Save and Reset

### *Clerk Messages Off*

- Program Mode
- Hex 3
- Hex 3
- Hex 0
- Save and Reset

Because the clerk messages are a subset of the Voice Messages, disabling all voice messages disables the clerk messages also. All Voice Messages must be enabled for the Clerk Messages to be enabled.

The three clerk messages are:

1. Scale failed, clean under scale deck
2. Scale failed, code 5, clean under scale deck

Next, do scale calibration

Next, change scale

3. Scale failed, code 4

Stop checkstand mechanical vibration

Next, change scale

### IBM-485 / IBM-USB Tag Data Format

This option is included because most IBM devices that have a select address of 4B require the bar code data to be transmitted as ASCII characters. Therefore, when selecting Communications Protocol choice 4 or B, NCR recommends that the tag format be set to ASCII. For handheld bar code readers, refer to the “Communications Protocol” section earlier in this chapter.

## Number System Character Parameter

### Your Program

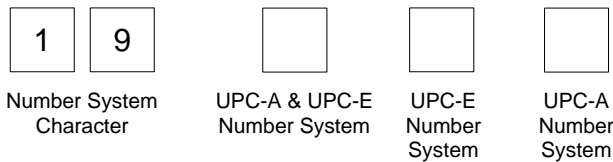

UPC-A & UPC-E Number System	0 Not Sent	1 Sent
UPC-E Number System	4 Not Sent	5 Sent
UPC-A Number System	6 Not Sent	7 Sent

24040

This parameter determines whether the UPC-A and UPC-E number system character is sent or not. The following are the options for this parameter.

- **Hex 0**—UPC-A and UPC-E Number System Character Not Sent
- **Hex 1**—UPC-A and UPC-E Number System Character Sent
- **Hex 4**—UPC-E Number System Character Not Sent

- **Hex 5**—UPC-E Number System Character Sent
- **Hex 6**—UPC-A Number System Character Not Sent
- **Hex 7**—UPC-A Number System Character Sent

## Dual Cable Interface

The Dual Cable Interface programming mode identifies the scale type to the host terminal.

The scale type normally does not need changing unless you are connecting the 7874 to a competitive host terminal.

### Avery Scale Emulation

To enable Avery Scale Emulation, scan the following Hex tags.

- **Program Mode, Hex 4, Hex 0, Hex 1**—enable AUX port processing
- **Hex 4, Hex 0, Hex 2**—enable AUX port 1
- **Hex 5, Hex 5, Hex 6**—enable Avery Scale Emulation

## Programming Worksheets

The programming worksheets provide a convenient method of defining the 7874 program before loading it into the unit. Each worksheet relates to a Parameter Program.

The programming worksheets permit the exact sequence of tags to scan for each programming parameter to be determined. It also provides a hard copy of the program for possible future use.

The top half of each worksheet identifies the programming parameters and the specific tags for each one. Most of the worksheets contain arrows that guide through the proper sequence. The bottom half of each worksheet provides a place to write in each selection.

Most of the worksheets contain shortcuts that permit specific parameters to be entered without entering the entire worksheet. These parameters have an alpha character in a box just left of the parameter name. Scanning the Hex tag that corresponds to the alpha character enables input for that parameter. Scan the tags that pertain to that parameter. After entering the specified parameter, the program returns to Program Mode.

## Communications Protocol

### Your Program

1	0	
Communications Protocol	Protocol	

### Protocol

3	4	5
IBM Slot Scanner	IBM Hand-Held Bar Code Reader	RS-232
D	E 0	E 2
IBM USB	NCR (RS-232) USB	Wedge

## Good Read Tone

### Your Program

1	1	
---	---	--

Good Read Tone Protocol

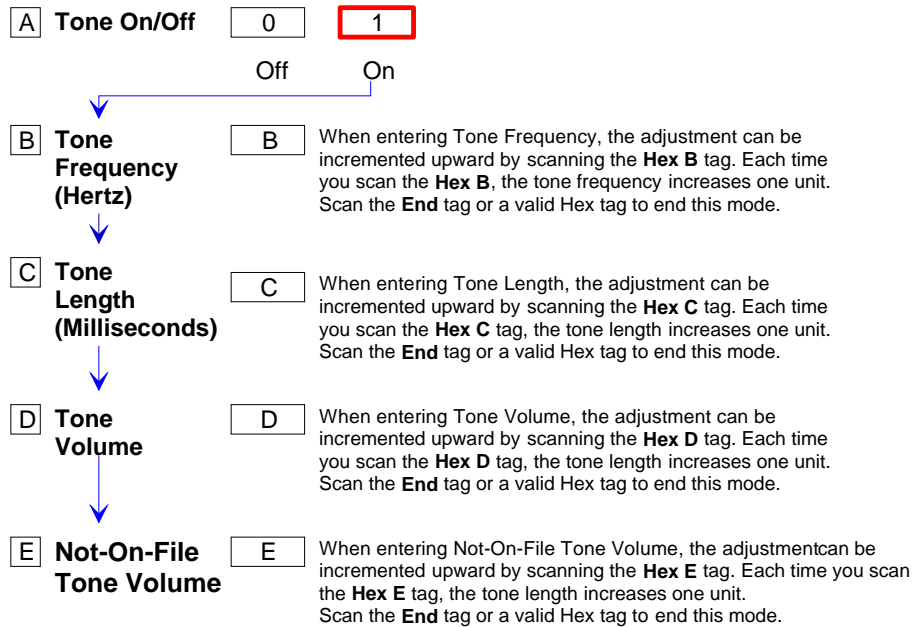

22761

# Timers

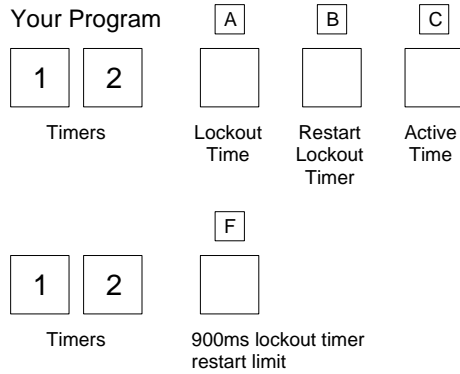

---

**A Lockout Time (Milliseconds)**

<input type="text" value="8"/>	<input checked="" type="text" value="0"/>	<input type="text" value="1"/>	<input type="text" value="2"/>	<input type="text" value="3"/>
350	450	600	750	900
<input type="text" value="4"/>	<input type="text" value="5"/>	<input type="text" value="6"/>	<input type="text" value="7"/>	
1050	1200	1350	1500	

↓

**B Restart Lockout Timer**

<input type="text" value="0"/>	<input checked="" type="text" value="1"/>
Off	On

↓

**C Active Time (Minutes)**

<input type="text" value="0"/>	<input checked="" type="text" value="1"/>	<input type="text" value="2"/>	<input type="text" value="3"/>
0	15	30	60

**F 900ms Lockout Timer Restart Limit**

<input checked="" type="text" value="0"/>	<input type="text" value="1"/>
Disable	Enable

**NOTE:** Direct Entry Only.  
If the Restart Lockout Timer [B] is set to OFF, the 900 ms Lockout Timer Restart Limit [F] has no effect.

**NOTE:** NCR suggests that you do not set the Active Time parameter to 0. Leaving the laser light on all the time reduces its life expectancy.

# Bar Codes-1

## Your Program

<b>A</b>	<b>B</b>	<b>C</b>	<b>D</b>	<b>E</b>				<b>F</b>
1	3							
Bar Codes - 1	UPC/EAN	Unused	Extend UPC-A	Extend UPC-E	Periodical Codes	Periodical Code Extension	Send Data	Set 2 Tag Label

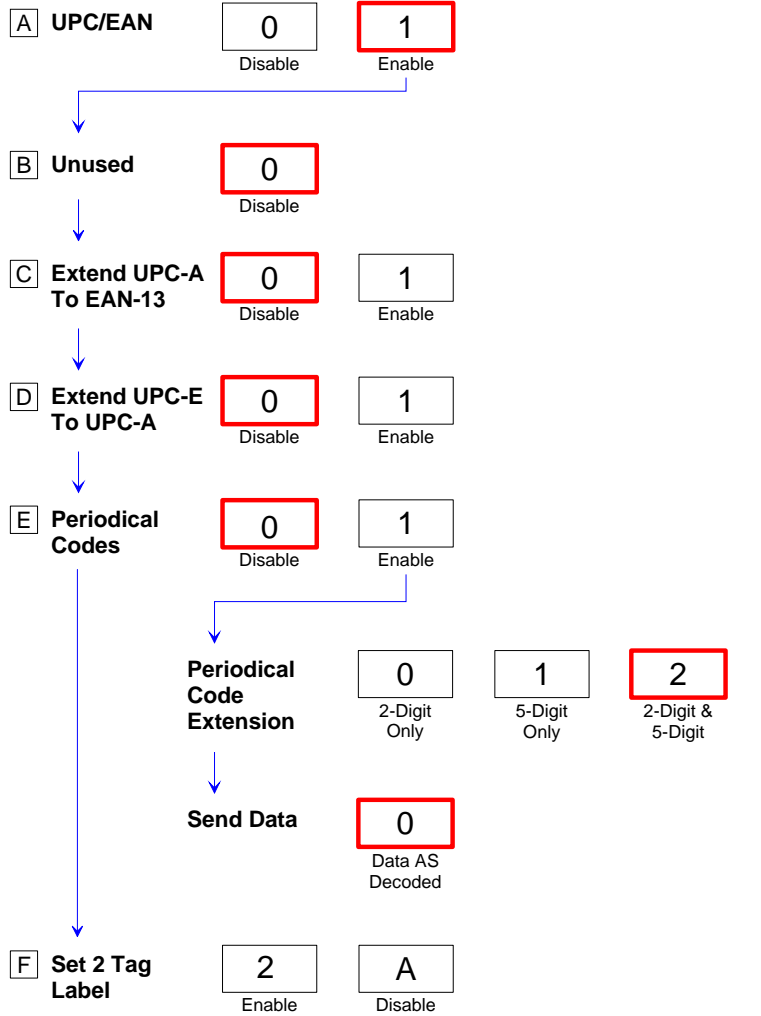

## Bar Codes-2

### Your Program

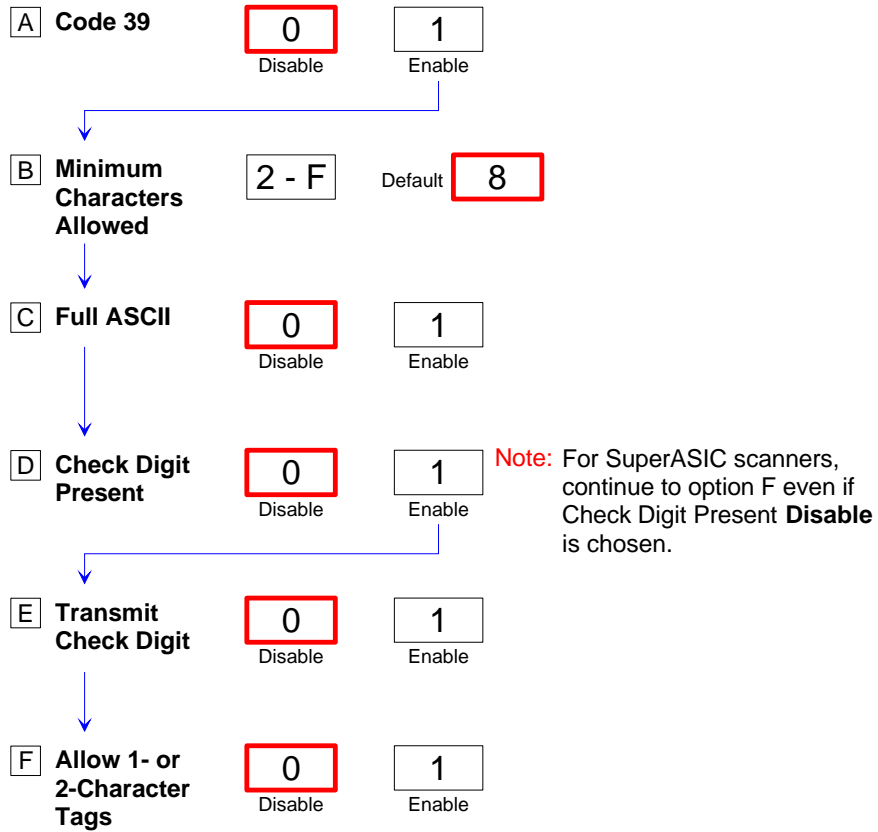
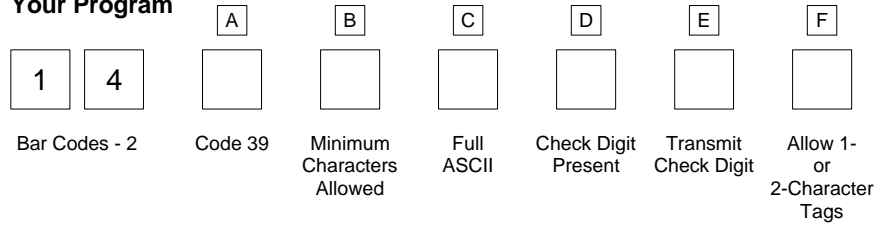



# Bar Codes-3

## Your Program

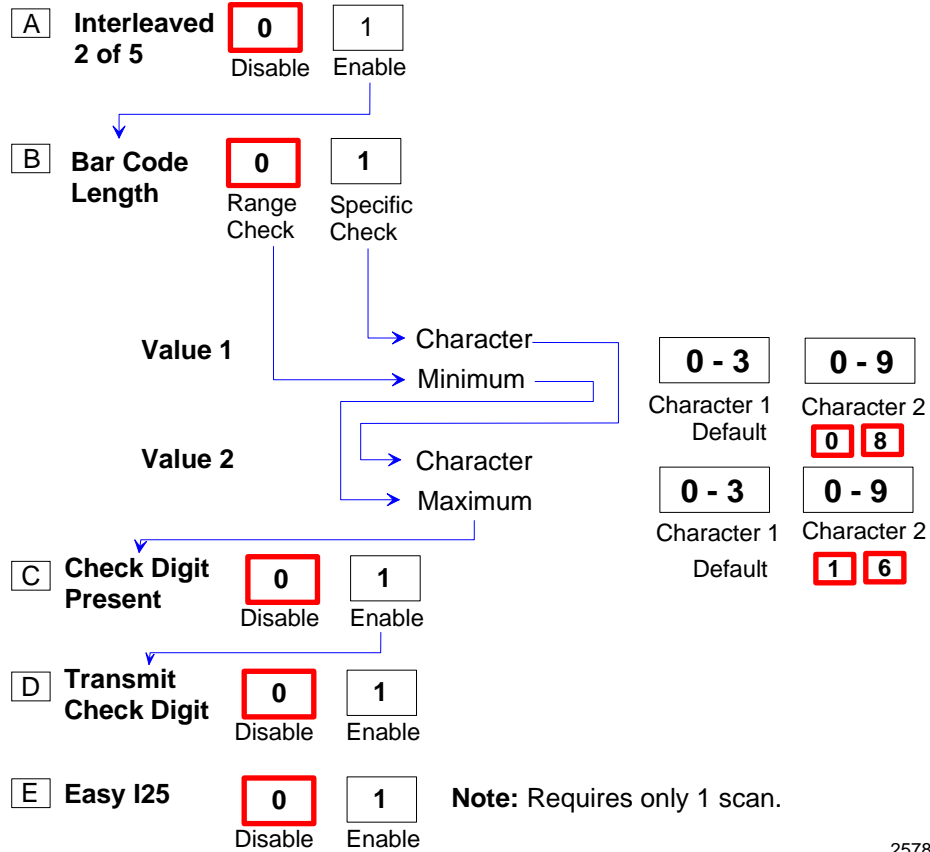
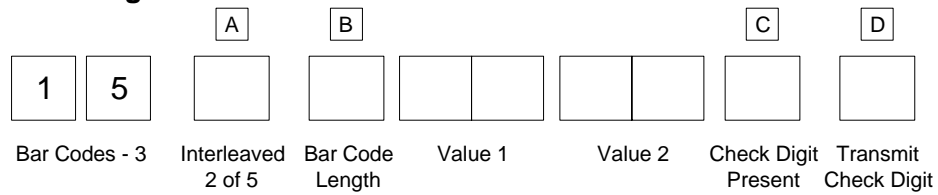

# Bar Codes-4

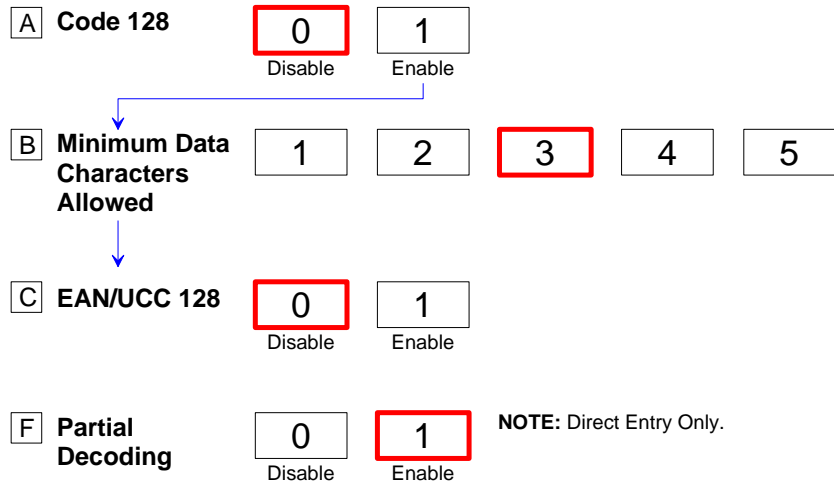
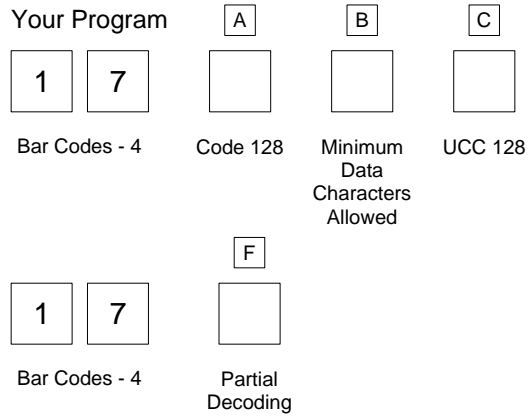

# Bar Codes-5

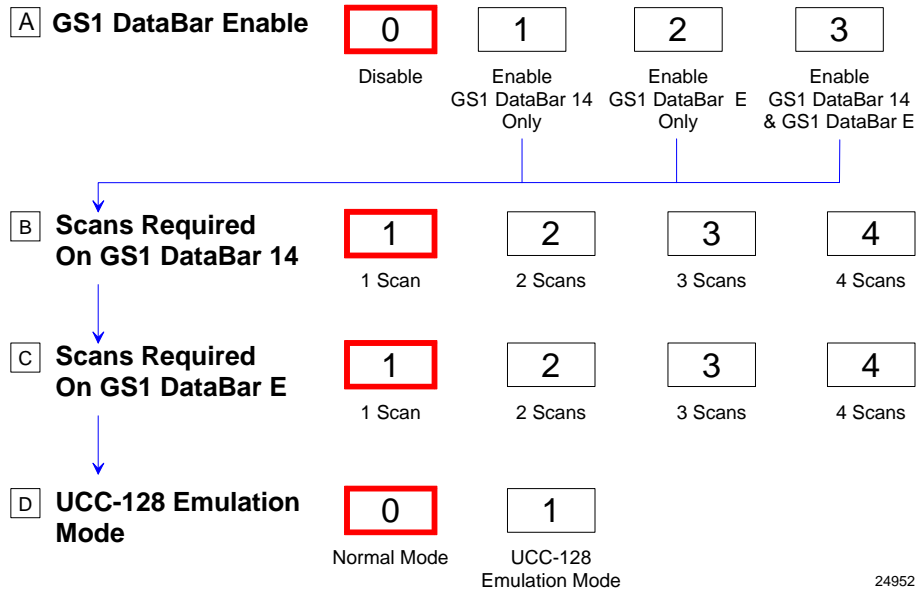
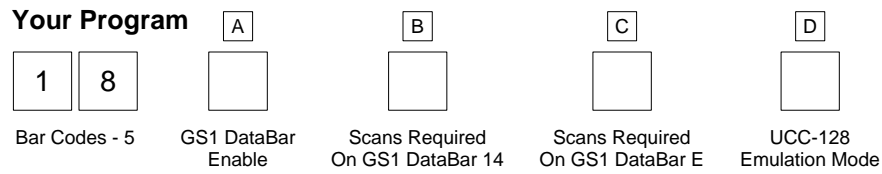

## Bar Codes-6

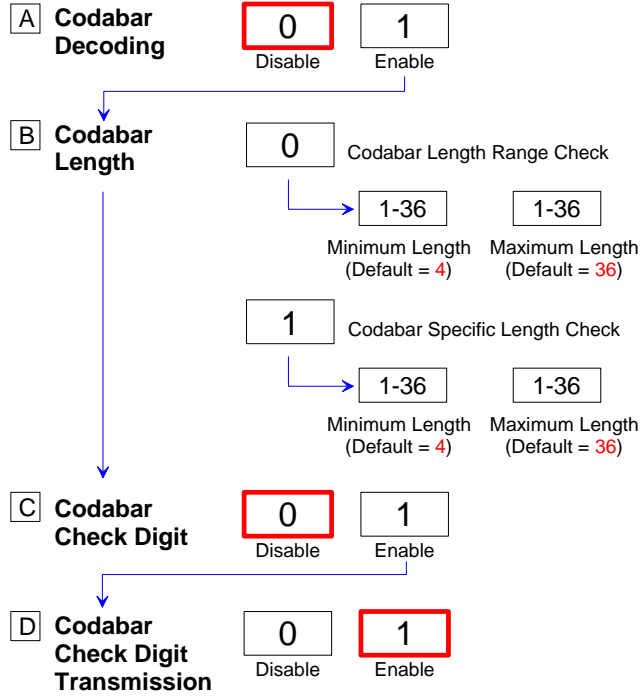
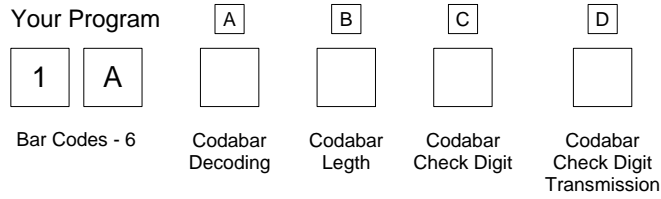

25515

## Bar Codes-7

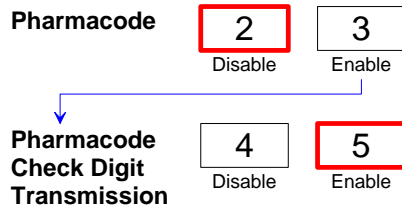

25516

# Label Identifiers

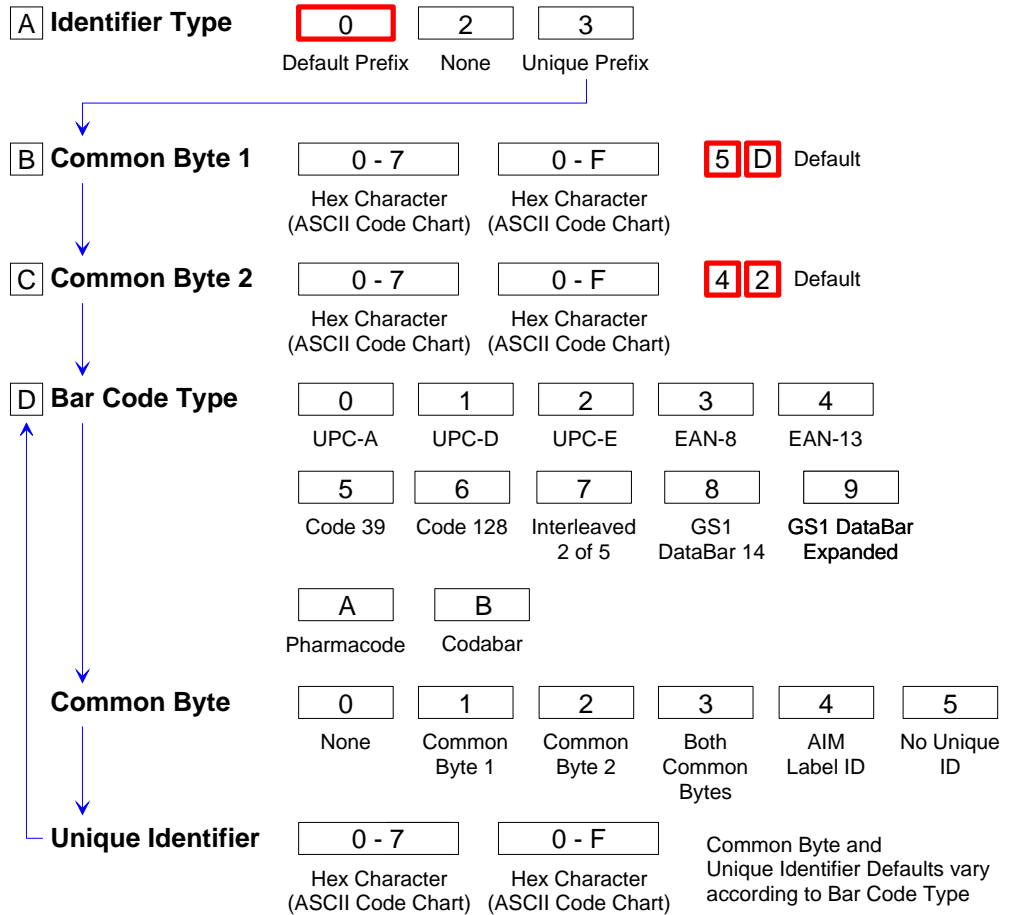
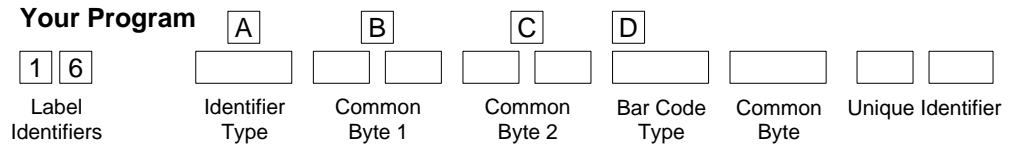

## Number System Character

### Your Program

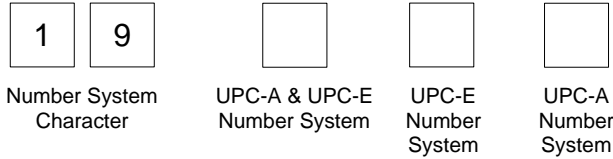

UPC-A & UPC-E Number System	0 Not Sent	1 Sent
UPC-E Number System	4 Not Sent	5 Sent
UPC-A Number System	6 Not Sent	7 Sent

24040

## Sensormatic Deactivation Tone Frequency

### Your Program

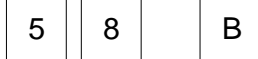

B	Tone Frequency (Hertz)	B	When entering Tone Frequency, the adjustment can be incremented upward by scanning the Hex B tag. Each time you scan the Hex B, the tone frequency increases one unit. Scan the End tag or a valid Hex tag to end this mode. The eight frequencies to choose from are 570 Hz (Default), 637 Hz, 721 Hz, 829 Hz, 976 Hz, 1186 Hz, 1512 Hz, and 2083 Hz.
---	------------------------	---	--

25913

## Sensormatic Deactivation Tone Pulse

### Your Program



X	The tone is a series of five pulses. The values of 1-8 generates 1 to 8 pulses of the frequency. The values 9-F generates 1 to 7 pulses of the frequency modulated with a second tone. The eight frequencies are: 570 Hz(default), 637 Hz, 721 Hz, 829 Hz, 976 Hz, 1186 Hz, 1512 Hz, and 2083 Hz.
---	---

25912

# RS232 Parameters 1

## Your Program

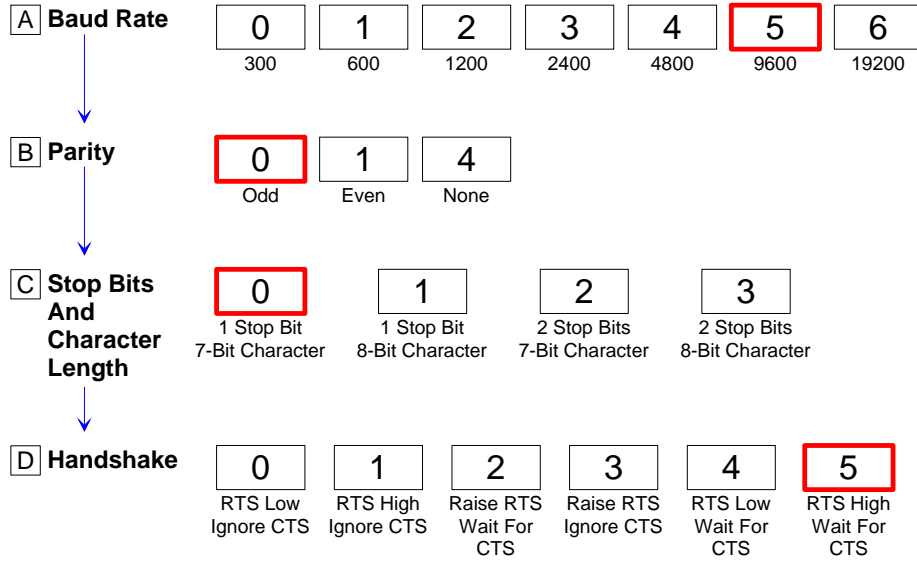
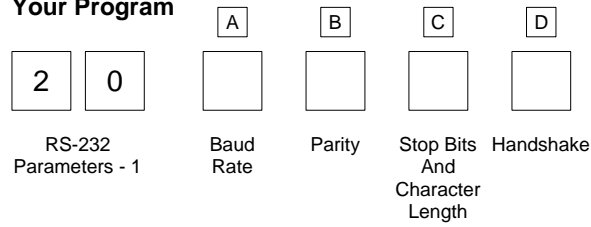

## RS232 Parameters 2

### Your Program

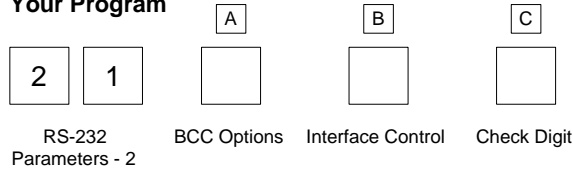

### A BCC Options

0	1
Disable	Enable

### B Interface Control

0	1	2	3
None	ACK/NAK	XOn/XOff	ACK/NAK & XOn/XOff

### C Check Digit

1	2	3	4	5	6	7	8	9	A	B
Enable UPC-A Enable EAN-8 Enable EAN-13 Disable UPC-E	Disable UPC-A Disable EAN-8 Disable EAN-13 Disable UPC-E	Disable UPC-A Disable EAN-8 Disable EAN-13 Enable UPC-E	Disable UPC-A Disable EAN-8 Enable EAN-13 Disable UPC-E	Disable UPC-A Disable EAN-8 Enable EAN-13 Enable UPC-E	Disable UPC-A Disable EAN-8 Enable EAN-13 Disable UPC-E	Disable UPC-A Enable EAN-8 Disable EAN-13 Enable UPC-E	Disable UPC-A Enable EAN-8 Enable EAN-13 Disable UPC-E	Disable UPC-A Enable EAN-8 Enable EAN-13 Enable UPC-E	Enable UPC-A Disable EAN-8 Disable EAN-13 Disable UPC-E	Enable UPC-A Disable EAN-8 Disable EAN-13 Enable UPC-E
Enable UPC-A Disable EAN-8 Enable EAN-13 Disable UPC-E	Enable UPC-A Disable EAN-8 Enable EAN-13 Enable UPC-E	Enable UPC-A Enable EAN-8 Disable EAN-13 Disable UPC-E	Enable UPC-A Disable EAN-8 Enable EAN-13 Disable UPC-E	Enable UPC-A Disable EAN-8 Enable EAN-13 Enable UPC-E	Enable UPC-A Enable EAN-8 Disable EAN-13 Disable UPC-E	Enable UPC-A Enable EAN-8 Disable EAN-13 Enable UPC-E	Enable UPC-A Enable EAN-8 Enable EAN-13 Disable UPC-E	Enable UPC-A Disable EAN-8 Enable EAN-13 Enable UPC-E	Enable UPC-A Enable EAN-8 Disable EAN-13 Disable UPC-E	Enable UPC-A Enable EAN-8 Disable EAN-13 Enable UPC-E



## RS232 Prefix Byte

**Your Program**

		A	B
2	2		
RS-232 Prefix Byte		Prefix Byte	ASCII Code

---

**A Prefix Byte**  0  1  
 Disable Enable

**B ASCII Code**  0 - 7  0 - F  0  2 Default  
 Hex Character (ASCII Code Chart) Hex Character (ASCII Code Chart)

22774

## RS232 Terminator Byte

**Your Program**

		A	B	C
2	3			
RS-232 Terminator Byte		Terminator Byte 1	ASCII Code	Terminator Byte 2
				ASCII Code

---

**A Terminator Byte 1**  0  1 **NOTE:** Terminator Byte 1 is required on a scale unit. If you select **Disable**, it is ignored and an ETX (03) is sent.  
 Disable Enable

**B ASCII Code**  0 - 7  0 - F  0  3 Default  
 Hex Character (ASCII Code Chart) Hex Character (ASCII Code Chart)

**C Terminator Byte 2**  0  1 **NOTE:** Terminator Byte 2 is a direct entry only.  
 Disable Enable

**ASCII Code**  0 - 7  0 - F  0  3 Default  
 Hex Character (ASCII Code Chart) Hex Character (ASCII Code Chart)

25786

## RS232 Communications Options

### Your Program

<input type="text" value="2"/>	<input type="text" value="4"/>	<input type="text"/>	<input type="text"/>	<input type="text"/>
Communication Options	RS-232 Delay	Scanner or Scanner / Scale Format	Good Weigh Tone	

---

RS-232 Delay	<input type="text" value="0"/>	<input type="text" value="1"/>	<input type="text" value="2"/>
	No Delay	10 Milliseconds	50 Milliseconds

Scanner or Scanner / Scale Format	<input type="text" value="4"/>	<input type="text" value="5"/>
	Scanner Only	Scanner / Scale

Good Weigh Tone	<input type="text" value="8"/>	<input type="text" value="9"/>
	Disable	Enable

22779

## Scale Parameters

### Your Program

<input type="text" value="3"/>	<input type="text" value="0"/>	<input type="text"/>	<input type="text"/>
Scale Parameters	Model	IBM Address	

---

Model	<input type="text" value="3"/>	<input type="text" value="4"/>
	Scanner/Scale	Scanner Only

IBM address	<input type="text" value="5"/>	<input type="text" value="6"/>	<input type="text" value="7"/>
	Address 6A	Address 6B	Address 6E

22818

## Miscellaneous Options

### Miscellaneous Parameters

#### Your Program

<input type="text" value="3"/>	<input type="text" value="2"/>	<input type="text"/>	<input type="text"/>	<input type="text"/>	<input type="text"/>
Miscellaneous Parameters	Host Tone Control	IBM Retransmit Control	Speech	IBM-485 / IBM-USB Tag Data Format	

#### Host Tone Control

<input type="text" value="3"/>	<input type="text" value="4"/>
Disable	Enable

#### IBM Retransmit Control

<input type="text" value="7"/>	<input type="text" value="8"/>
3 Times	Forever

#### Speech

<input type="text" value="D"/>
Toggle Between Enable and Disable Speech

#### IBM-485 / IBM-USB Tag Data Format

<input type="text" value="E"/>	<input type="text" value="F"/>
Hex	ASCII

22813

### Code 128 Tone Length

Selection	Programming Tag Sequence
0 ms	Programming Mode, Hex 7, Hex 0, Hex 0, Hex 0, Save and Reset
15 ms	Programming Mode, Hex 7, Hex 0, Hex 0, Hex 1, Save and Reset
30 ms	Programming Mode, Hex 7, Hex 0, Hex 0, Hex 2, Save and Reset
45 ms	Programming Mode, Hex 7, Hex 0, Hex 0, Hex 3, Save and Reset
60 ms	Programming Mode, Hex 7, Hex 0, Hex 0, Hex 4, Save and Reset
75 ms	Programming Mode, Hex 7, Hex 0, Hex 0, Hex 5, Save and Reset
90 ms	Programming Mode, Hex 7, Hex 0, Hex 0, Hex 6, Save and Reset
105 ms	Programming Mode, Hex 7, Hex 0, Hex 0, Hex 7, Save and Reset
120 ms	Programming Mode, Hex 7, Hex 0, Hex 0, Hex 8, Save and Reset
135 ms	Programming Mode, Hex 7, Hex 0, Hex 0, Hex 9, Save and Reset
150 ms	Programming Mode, Hex 7, Hex 0, Hex 0, Hex A, Save and Reset
165 ms	Programming Mode, Hex 7, Hex 0, Hex 0, Hex B, Save and Reset
180 ms	Programming Mode, Hex 7, Hex 0, Hex 0, Hex C, Save and Reset
195 ms	Programming Mode, Hex 7, Hex 0, Hex 0, Hex D, Save and Reset
210 ms	Programming Mode, Hex 7, Hex 0, Hex 0, Hex E, Save and Reset
225 ms	Programming Mode, Hex 7, Hex 0, Hex 0, Hex F, Save and Reset

24383

## Code 128 Tone Frequency

Selection	Programming Tag Sequence	Setting
702 Hz	Programming Mode, Hex 7, Hex 4, Hex 1, Hex 0, Save and Reset	
781 Hz	Programming Mode, Hex 7, Hex 4, Hex 1, Hex 1, Save and Reset	
868 Hz	Programming Mode, Hex 7, Hex 4, Hex 1, Hex 2, Save and Reset	
961 Hz	Programming Mode, Hex 7, Hex 4, Hex 1, Hex 3, Save and Reset	
1071 Hz	Programming Mode, Hex 7, Hex 4, Hex 1, Hex 4, Save and Reset	Default
1187 Hz	Programming Mode, Hex 7, Hex 4, Hex 1, Hex 5, Save and Reset	
570 Hz	Programming Mode, Hex 7, Hex 4, Hex 1, Hex 6, Save and Reset	
633 Hz	Programming Mode, Hex 7, Hex 4, Hex 1, Hex 7, Save and Reset	

24468

## Code 128 Tone

Selection	Programming Tag Sequence
Disable	Programming Mode, Hex 7, Hex 0, Hex 2, Hex 0, Save and Reset
Enable	Programming Mode, Hex 7, Hex 0, Hex 2, Hex 1, Save and Reset

24384

## Code 128 Minimum and Maximum Tag Length

Selection	Programming Tag Sequence
Length	Programming Mode, Hex 7, Hex 2, a, v, w, x, y, Save and Reset where a = Ø (Range of lengths) or 1 (Specific Length) v = 1-3 (default is 3) w = 1-9 (default is 9) x = 1-3 (default is 3) y = 1-9 (default is 9)
Default	Scan Default Tag

24954

## Code 128 Stitch

Selection	Programming Tag Sequence
Disable	Programming Mode, Hex 7, Hex 0, Hex 9, Hex C, Save and Reset
Enable	Programming Mode, Hex 7, Hex 0, Hex 9, Hex D, Save and Reset

24386

## Code 39 Tone Length

Selection	Programming Tag Sequence
0 ms	Programming Mode, Hex 7, Hex 0, Hex 3, Hex 0, Save and Reset
15 ms	Programming Mode, Hex 7, Hex 0, Hex 3, Hex 1, Save and Reset
30 ms	Programming Mode, Hex 7, Hex 0, Hex 3, Hex 2, Save and Reset
45 ms	Programming Mode, Hex 7, Hex 0, Hex 3, Hex 3, Save and Reset
60 ms	Programming Mode, Hex 7, Hex 0, Hex 3, Hex 4, Save and Reset
75 ms	Programming Mode, Hex 7, Hex 0, Hex 3, Hex 5, Save and Reset
90 ms	Programming Mode, Hex 7, Hex 0, Hex 3, Hex 6, Save and Reset
105 ms	Programming Mode, Hex 7, Hex 0, Hex 3, Hex 7, Save and Reset
120 ms	Programming Mode, Hex 7, Hex 0, Hex 3, Hex 8, Save and Reset
135 ms	Programming Mode, Hex 7, Hex 0, Hex 3, Hex 9, Save and Reset
150 ms	Programming Mode, Hex 7, Hex 0, Hex 3, Hex A, Save and Reset
165 ms	Programming Mode, Hex 7, Hex 0, Hex 3, Hex B, Save and Reset
180 ms	Programming Mode, Hex 7, Hex 0, Hex 3, Hex C, Save and Reset
195 ms	Programming Mode, Hex 7, Hex 0, Hex 3, Hex D, Save and Reset
210 ms	Programming Mode, Hex 7, Hex 0, Hex 3, Hex E, Save and Reset
225 ms	Programming Mode, Hex 7, Hex 0, Hex 3, Hex F, Save and Reset

24385

## Code 39 Tone Frequency

Selection	Programming Tag Sequence	Setting
702 Hz	Programming Mode, Hex 7, Hex 0, Hex 4, Hex 0, Save and Reset	
781 Hz	Programming Mode, Hex 7, Hex 0, Hex 4, Hex 1, Save and Reset	
868 Hz	Programming Mode, Hex 7, Hex 0, Hex 4, Hex 2, Save and Reset	
961 Hz	Programming Mode, Hex 7, Hex 0, Hex 4, Hex 3, Save and Reset	
1071 Hz	Programming Mode, Hex 7, Hex 0, Hex 4, Hex 4, Save and Reset	Default
1187 Hz	Programming Mode, Hex 7, Hex 0, Hex 4, Hex 5, Save and Reset	
570 Hz	Programming Mode, Hex 7, Hex 0, Hex 4, Hex 6, Save and Reset	
633 Hz	Programming Mode, Hex 7, Hex 0, Hex 4, Hex 7, Save and Reset	

25900

## Code 39 Tone

Selection	Programming Tag Sequence
Disable	Programming Mode, Hex 7, Hex 0, Hex 5, Hex 0, Save and Reset
Enable	Programming Mode, Hex 7, Hex 0, Hex 5, Hex 1, Save and Reset

24388

## Code 39 Quiet Zone

Selection	Programming Tag Sequence
Disable	Programming Mode, Hex 7, Hex 0, Hex 5, Hex 2, Save and Reset
Enable	Programming Mode, Hex 7, Hex 0, Hex 5, Hex 3, Save and Reset

24389

## Code 39 InterCharacter Gap Check

Selection	Programming Tag Sequence
Enable	Programming Mode, Hex 7, Hex 0, Hex 5, Hex 5, Save and Reset
Disable	Programming Mode, Hex 7, Hex 0, Hex 5, Hex 4, Save and Reset

24390

## Code 39 Halves

Selection	Programming Tag Sequence
Disable	Programming Mode, Hex 7, Hex 0, Hex 9, Hex 0, Save and Reset
Enable	Programming Mode, Hex 7, Hex 0, Hex 9, Hex 1, Save and Reset

24451

## Code 39 Stitch

Selection	Programming Tag Sequence
Disable	Programming Mode, Hex 7, Hex 0, Hex 9, Hex 2, Save and Reset
Enable	Programming Mode, Hex 7, Hex 0, Hex 9, Hex 3, Save and Reset

24452

## Code 39 CD Length1

Selection	Programming Tag Sequence	Setting
Length	Programming Mode, Hex 7, Hex 0, Hex B, x, y, Save and Reset CD Length $x\ y = 01 - 36$ where if $x = 0, y = 1 - 9$ $x = 1, y = 0 - 9$ $x = 2, y = 0 - 9$ $x = 3, y = 0 - 6$	
Disable	Programming Mode, Hex 7, Hex 0, Hex B, Hex 0, Hex 0, Save and Reset	Default

24454

## Code 39 CD Length2

Selection	Programming Tag Sequence	Setting
Length	Programming Mode, Hex 7, Hex 0, Hex C, x, y, Save and Reset CD Length $x y = 01 - 36$ where if $x = 0, y = 1 - 9$ $x = 1, y = 0 - 9$ $x = 2, y = 0 - 9$ $x = 3, y = 0 - 6$	
Disable	Programming Mode, Hex 7, Hex 0, Hex C, Hex 0, Hex 0, Save and Reset	Default

24455

## Code 39 Minimum and Maximum Length

Selection	Programming Tag Sequence	Setting
Length	Programming Mode, Hex 7, Hex 0, Hex F, a, vw, xy, Save and Reset where a = range (1-36) vw = c39 minimum length xy = c39 maximum length	

25787

## Interleaved 2 of 5 Tone Length

Selection	Programming Tag Sequence	Setting
0 ms	Programming Mode, Hex 7, Hex 0, Hex 6, Hex 0, Save and Reset	
15 ms	Programming Mode, Hex 7, Hex 0, Hex 6, Hex 1, Save and Reset	
30 ms	Programming Mode, Hex 7, Hex 0, Hex 6, Hex 2, Save and Reset	
45 ms	Programming Mode, Hex 7, Hex 0, Hex 6, Hex 3, Save and Reset	
60 ms	Programming Mode, Hex 7, Hex 0, Hex 6, Hex 4, Save and Reset	
75 ms	Programming Mode, Hex 7, Hex 0, Hex 6, Hex 5, Save and Reset	
90 ms	Programming Mode, Hex 7, Hex 0, Hex 6, Hex 6, Save and Reset	
105 ms	Programming Mode, Hex 7, Hex 0, Hex 6, Hex 7, Save and Reset	
120 ms	Programming Mode, Hex 7, Hex 0, Hex 6, Hex 8, Save and Reset	
135 ms	Programming Mode, Hex 7, Hex 0, Hex 6, Hex 9, Save and Reset	
150 ms	Programming Mode, Hex 7, Hex 0, Hex 6, Hex A, Save and Reset	
165 ms	Programming Mode, Hex 7, Hex 0, Hex 6, Hex B, Save and Reset	
180 ms	Programming Mode, Hex 7, Hex 0, Hex 6, Hex C, Save and Reset	
195 ms	Programming Mode, Hex 7, Hex 0, Hex 6, Hex D, Save and Reset	
210 ms	Programming Mode, Hex 7, Hex 0, Hex 6, Hex E, Save and Reset	
225 ms	Programming Mode, Hex 7, Hex 0, Hex 6, Hex F, Save and Reset	

24456

## Interleaved 2 of 5 Tone Frequency

Selection	Programming Tag Sequence	Setting
702 Hz	Programming Mode, Hex 7, Hex 0, Hex 7, Hex 0, Save and Reset	
781 Hz	Programming Mode, Hex 7, Hex 0, Hex 7, Hex 1, Save and Reset	
868 Hz	Programming Mode, Hex 7, Hex 0, Hex 7, Hex 2, Save and Reset	
961 Hz	Programming Mode, Hex 7, Hex 0, Hex 7, Hex 3, Save and Reset	
1071 Hz	Programming Mode, Hex 7, Hex 0, Hex 7, Hex 4, Save and Reset	Default
1187 Hz	Programming Mode, Hex 7, Hex 0, Hex 7, Hex 5, Save and Reset	
570 Hz	Programming Mode, Hex 7, Hex 0, Hex 7, Hex 6, Save and Reset	
633 Hz	Programming Mode, Hex 7, Hex 0, Hex 7, Hex 7, Save and Reset	

25901

## Interleaved 2 of 5 Tone

Selection	Programming Tag Sequence
Disable	Programming Mode, Hex 7, Hex 0, Hex 8, Hex 0, Save and Reset
Enable	Programming Mode, Hex 7, Hex 0, Hex 8, Hex 1, Save and Reset

24458

## Interleaved 2 of 5 CD Length1

Selection	Programming Tag Sequence	Setting
Length	Programming Mode, Hex 7, Hex 0, Hex D, x, y, Save and Reset CD Length $x y = 04 - 58$ where if $x = 0, y = 4 - 9$ $x = 1, y = 0 - 9$ $x = 2, y = 0 - 9$ $x = 3, y = 0 - 9$ $x = 4, y = 0 - 9$ $x = 5, y = 0 - 8$	
Disable	Programming Mode, Hex 7, Hex 0, Hex D, Hex 0, Hex 0, Save and Reset	Default

24460



## Interleaved 2 of 5 CD Length2

Selection	Programming Tag Sequence	Setting
Length	Programming Mode, Hex 7, Hex 0, Hex E, x, y, Save and Reset CD Length $x y = 04 - 58$ where if $x = 0, y = 4 - 9$ $x = 1, y = 0 - 9$ $x = 2, y = 0 - 9$ $x = 3, y = 0 - 9$ $x = 4, y = 0 - 9$ $x = 5, y = 0 - 8$	
Disable	Programming Mode, Hex 7, Hex 0, Hex E, Hex 0, Hex 0, Save and Reset	Default

24461

## Interleaved 2 of 5 Scans Required

Selection	Programming Tag Sequence	Setting
1 scan	Programming Mode, Hex 6, Hex B, Hex 5, Hex 1, Save and Reset	
2 scans	Programming Mode, Hex 6, Hex B, Hex 5, Hex 2, Save and Reset	Default
3 scans	Programming Mode, Hex 6, Hex B, Hex 5, Hex 3, Save and Reset	
4 scans	Programming Mode, Hex 6, Hex B, Hex 5, Hex 4, Save and Reset	

**Note:** This is an Advanced Programming Feature and should only be done under the recommendation and direction of NCR; otherwise, unexpected results may occur.

25645

## Interleaved 2 of 5 Overlap

Selection	Programming Tag Sequence	Setting
1 overlap	Programming Mode, Hex 6, Hex B, Hex B, Hex 1, Save and Reset	Default
2 overlaps	Programming Mode, Hex 6, Hex B, Hex B, Hex 2, Save and Reset	
3 overlaps	Programming Mode, Hex 6, Hex B, Hex B, Hex 3, Save and Reset	
4 overlaps	Programming Mode, Hex 6, Hex B, Hex B, Hex 4, Save and Reset	

**Note:** This is an Advanced Programming Feature and should only be done under the recommendation and direction of NCR; otherwise, unexpected results may occur.

25646

## Interleaved 2 of 5 Minimum Segment Size

Selection	Programming Tag Sequence	Setting
2 segment size	Programming Mode, Hex 6, Hex B, Hex E, Hex 2, Save and Reset	
3 segment size	Programming Mode, Hex 6, Hex B, Hex E, Hex 3, Save and Reset	Default
4 segment size	Programming Mode, Hex 6, Hex B, Hex E, Hex 4, Save and Reset	
5 segment size	Programming Mode, Hex 6, Hex B, Hex E, Hex 5, Save and Reset	
6 segment size	Programming Mode, Hex 6, Hex B, Hex E, Hex 6, Save and Reset	
7 segment size	Programming Mode, Hex 6, Hex B, Hex E, Hex 7, Save and Reset	
8 segment size	Programming Mode, Hex 6, Hex B, Hex E, Hex 8, Save and Reset	
9 segment size	Programming Mode, Hex 6, Hex B, Hex E, Hex 9, Save and Reset	

**Note:** This is an Advanced Programming Feature and should only be done under the recommendation and direction of NCR; otherwise, unexpected results may occur.

25647

## Enable/Disable Interleaved 2 of 5 Partial

Selection	Programming Tag Sequence	Setting
Disable	Programming Mode, Hex 6, Hex C, Hex C, Save and Reset	Default
Enable	Programming Mode, Hex 6, Hex C, Hex D, Save and Reset	

**Note:** This is an Advanced Programming Feature and should only be done under the recommendation and direction of NCR; otherwise, unexpected results may occur.

27060

## GS1 DataBar Tone Length

Selection	Programming Tag Sequence	Setting
0 ms	Programming Mode, Hex 7, Hex 4, Hex 0, Hex 0, Save and Reset	
15 ms	Programming Mode, Hex 7, Hex 4, Hex 0, Hex 1, Save and Reset	
30 ms	Programming Mode, Hex 7, Hex 4, Hex 0, Hex 2, Save and Reset	
45 ms	Programming Mode, Hex 7, Hex 4, Hex 0, Hex 3, Save and Reset	Default
60 ms	Programming Mode, Hex 7, Hex 4, Hex 0, Hex 4, Save and Reset	
75 ms	Programming Mode, Hex 7, Hex 4, Hex 0, Hex 5, Save and Reset	
90 ms	Programming Mode, Hex 7, Hex 4, Hex 0, Hex 6, Save and Reset	
105 ms	Programming Mode, Hex 7, Hex 4, Hex 0, Hex 7, Save and Reset	
120 ms	Programming Mode, Hex 7, Hex 4, Hex 0, Hex 8, Save and Reset	
135 ms	Programming Mode, Hex 7, Hex 4, Hex 0, Hex 9, Save and Reset	
150 ms	Programming Mode, Hex 7, Hex 4, Hex 0, Hex A, Save and Reset	
165 ms	Programming Mode, Hex 7, Hex 4, Hex 0, Hex B, Save and Reset	
180 ms	Programming Mode, Hex 7, Hex 4, Hex 0, Hex C, Save and Reset	
195 ms	Programming Mode, Hex 7, Hex 4, Hex 0, Hex D, Save and Reset	
210 ms	Programming Mode, Hex 7, Hex 4, Hex 0, Hex E, Save and Reset	
225 ms	Programming Mode, Hex 7, Hex 4, Hex 0, Hex F, Save and Reset	

24961

## GS1 DataBar Tone Frequency

Selection	Programming Tag Sequence	Setting
702 Hz	Programming Mode, Hex 7, Hex 4, Hex 1, Hex 0, Save and Reset	
781 Hz	Programming Mode, Hex 7, Hex 4, Hex 1, Hex 1, Save and Reset	
868 Hz	Programming Mode, Hex 7, Hex 4, Hex 1, Hex 2, Save and Reset	
961 Hz	Programming Mode, Hex 7, Hex 4, Hex 1, Hex 3, Save and Reset	
1071 Hz	Programming Mode, Hex 7, Hex 4, Hex 1, Hex 4, Save and Reset	Default
1187 Hz	Programming Mode, Hex 7, Hex 4, Hex 1, Hex 5, Save and Reset	
570 Hz	Programming Mode, Hex 7, Hex 4, Hex 1, Hex 6, Save and Reset	
633 Hz	Programming Mode, Hex 7, Hex 4, Hex 1, Hex 7, Save and Reset	

25902

## GS1 DataBar Tone

Selection	Programming Tag Sequence	Setting
Disable	Programming Mode, Hex 7, Hex 4, Hex 2, Hex 0, Save and Reset	Default
Enable	Programming Mode, Hex 7, Hex 4, Hex 2, Hex 1, Save and Reset	

24963

## GS1 DataBar-E AI 93 to Code 39 Tag Data Conversion

Selection	Programming Tag Sequence	Setting
Disable	Programming Mode, Hex 7, Hex 0, Hex A, Hex 2, Save and Reset	Default
Enable	Programming Mode, Hex 7, Hex 0, Hex A, Hex 3, Save and Reset	

24955

## GS1 DataBar-E AI 94 to UCC-128 Tag Data Conversion

Selection	Programming Tag Sequence	Setting
Disable	Programming Mode, Hex 7, Hex 0, Hex A, Hex 4, Save and Reset	Default
Enable	Programming Mode, Hex 7, Hex 0, Hex A, Hex 5, Save and Reset	

24956

## GS1 DataBar-E AI 94 to Code-128 Tag Data Conversion

Selection	Programming Tag Sequence	Setting
Disable	Programming Mode, Hex 7, Hex 0, Hex A, Hex 6, Save and Reset	Default
Enable	Programming Mode, Hex 7, Hex 0, Hex A, Hex 7, Save and Reset	

24957

## GS1 DataBar-E AI 95 to Interleaved 2 of 5 Tag Data Conversion

Selection	Programming Tag Sequence	Setting
Disable	Programming Mode, Hex 7, Hex 0, Hex 9, Hex A, Save and Reset	Default
Enable	Programming Mode, Hex 7, Hex 0, Hex 9, Hex B, Save and Reset	

24958

## Codabar Tone Length

Selection	Programming Tag Sequence	Setting
0 ms	Programming Mode, Hex 7, Hex 4, Hex 3, Hex 0, Save and Reset	
15 ms	Programming Mode, Hex 7, Hex 4, Hex 3, Hex 1, Save and Reset	
30 ms	Programming Mode, Hex 7, Hex 4, Hex 3, Hex 2, Save and Reset	
45 ms	Programming Mode, Hex 7, Hex 4, Hex 3, Hex 3, Save and Reset	
60 ms	Programming Mode, Hex 7, Hex 4, Hex 3, Hex 4, Save and Reset	
75 ms	Programming Mode, Hex 7, Hex 4, Hex 3, Hex 5, Save and Reset	Default
90 ms	Programming Mode, Hex 7, Hex 4, Hex 3, Hex 6, Save and Reset	
105 ms	Programming Mode, Hex 7, Hex 4, Hex 3, Hex 7, Save and Reset	
120 ms	Programming Mode, Hex 7, Hex 4, Hex 3, Hex 8, Save and Reset	
135 ms	Programming Mode, Hex 7, Hex 4, Hex 3, Hex 9, Save and Reset	
150 ms	Programming Mode, Hex 7, Hex 4, Hex 3, Hex A, Save and Reset	
165 ms	Programming Mode, Hex 7, Hex 4, Hex 3, Hex B, Save and Reset	
180 ms	Programming Mode, Hex 7, Hex 4, Hex 3, Hex C, Save and Reset	
195 ms	Programming Mode, Hex 7, Hex 4, Hex 3, Hex D, Save and Reset	
210 ms	Programming Mode, Hex 7, Hex 4, Hex 3, Hex E, Save and Reset	
225 ms	Programming Mode, Hex 7, Hex 4, Hex 3, Hex F, Save and Reset	

25328

## Codabar Tone Frequency

Selection	Programming Tag Sequence	Setting
702 Hz	Programming Mode, Hex 7, Hex 4, Hex 4, Hex 0, Save and Reset	
781 Hz	Programming Mode, Hex 7, Hex 4, Hex 4, Hex 1, Save and Reset	
868 Hz	Programming Mode, Hex 7, Hex 4, Hex 4, Hex 2, Save and Reset	
961 Hz	Programming Mode, Hex 7, Hex 4, Hex 4, Hex 3, Save and Reset	
1071 Hz	Programming Mode, Hex 7, Hex 4, Hex 4, Hex 4, Save and Reset	Default
1187 Hz	Programming Mode, Hex 7, Hex 4, Hex 4, Hex 5, Save and Reset	
570 Hz	Programming Mode, Hex 7, Hex 4, Hex 4, Hex 6, Save and Reset	
633 Hz	Programming Mode, Hex 7, Hex 4, Hex 4, Hex 7, Save and Reset	

25329

## Codabar Tone

Selection	Programming Tag Sequence	Setting
Disable	Programming Mode, Hex 7, Hex 4, Hex 5, Hex 0, Save and Reset	Default
Enable	Programming Mode, Hex 7, Hex 4, Hex 5, Hex 1, Save and Reset	

25324

## Codabar Halves

Selection	Programming Tag Sequence	Setting
Disable	Programming Mode, Hex 7, Hex 4, Hex 5, Hex 2, Save and Reset	Default
Enable	Programming Mode, Hex 7, Hex 4, Hex 5, Hex 3, Save and Reset	

25325

## Codabar Stitch

Selection	Programming Tag Sequence	Setting
Disable	Programming Mode, Hex 7, Hex 4, Hex 5, Hex 4, Save and Reset	Default
Enable	Programming Mode, Hex 7, Hex 4, Hex 5, Hex 5, Save and Reset	

25513

## Codabar Require Start/Stop Match

Selection	Programming Tag Sequence	Setting
Disable	Programming Mode, Hex 6, Hex B, Hex 2, Hex 0, Save and Reset	Default
Enable	Programming Mode, Hex 6, Hex B, Hex 2, Hex 1, Save and Reset	

25320

## Codabar Require Quiet Zones

Selection	Programming Tag Sequence	Setting
Disable	Programming Mode, Hex 6, Hex B, Hex 2, Hex 2, Save and Reset	Default
Enable	Programming Mode, Hex 6, Hex B, Hex 2, Hex 3, Save and Reset	

**Note:** Ensure that this sequence is set to **Enable** if Codabar is programmed to read very short tags (tags with less than 4 data characters). This programmable prevents getting a very short Codabar tag from another barcode type or from package graphics.

25321

## Codabar Start/Stop Transmission

Selection	Programming Tag Sequence	Setting
Disable	Programming Mode, Hex 6, Hex B, Hex 2, Hex 5, Save and Reset	Default
Enable	Programming Mode, Hex 6, Hex B, Hex 2, Hex 4, Save and Reset	

25322

Selection	Programming Tag Sequence	Setting
abcd	Programming Mode, Hex 6, Hex B, Hex 1, Hex 0, Save and Reset	Default
ABCD	Programming Mode, Hex 6, Hex B, Hex 1, Hex 1, Save and Reset	
tn*e	Programming Mode, Hex 6, Hex B, Hex 1, Hex 2, Save and Reset	
TN*e	Programming Mode, Hex 6, Hex B, Hex 1, Hex 3, Save and Reset	

25327

## Codabar Hard Correlation

Selection	Programming Tag Sequence	Setting
Disable	Programming Mode, Hex 6, Hex B, Hex 2, Hex 6, Save and Reset	Default
Enable	Programming Mode, Hex 6, Hex B, Hex 2, Hex 7, Save and Reset	

25323

## Number of Codabar Overlaps Required

Selection	Programming Tag Sequence	Setting
1 overlap	Programming Mode, Hex 6, Hex B, Hex A, Hex 1, Save and Reset	
2 overlaps	Programming Mode, Hex 6, Hex B, Hex A, Hex 2, Save and Reset	
3 overlaps	Programming Mode, Hex 6, Hex B, Hex A, Hex 3, Save and Reset	
4 overlaps	Programming Mode, Hex 6, Hex B, Hex A, Hex 4, Save and Reset	

25580

## Number of Codabar Scans Required

Selection	Programming Tag Sequence	Setting
1 scan	Programming Mode, Hex 6, Hex B, Hex 6, Hex 1, Save and Reset	Default
2 scans	Programming Mode, Hex 6, Hex B, Hex 6, Hex 2, Save and Reset	
3 scans	Programming Mode, Hex 6, Hex B, Hex 6, Hex 3, Save and Reset	
4 scans	Programming Mode, Hex 6, Hex B, Hex 6, Hex 4, Save and Reset	

25326

## Number of Coupon Scans Required

Selection	Programming Tag Sequence
0 scan	Programming Mode, Hex 6, Hex B, Hex 0, Hex 0, Save and Reset
1 scan	Programming Mode, Hex 6, Hex B, Hex 0, Hex 1, Save and Reset
2 scans	Programming Mode, Hex 6, Hex B, Hex 0, Hex 2, Save and Reset
3 scans	Programming Mode, Hex 6, Hex B, Hex 0, Hex 3, Save and Reset
4 scans	Programming Mode, Hex 6, Hex B, Hex 0, Hex 4, Save and Reset
5 scans	Programming Mode, Hex 6, Hex B, Hex 0, Hex 5, Save and Reset
6 scans	Programming Mode, Hex 6, Hex B, Hex 0, Hex 6, Save and Reset
7 scans	Programming Mode, Hex 6, Hex B, Hex 0, Hex 7, Save and Reset
8 scans	Programming Mode, Hex 6, Hex B, Hex 0, Hex 8, Save and Reset
9 scans	Programming Mode, Hex 6, Hex B, Hex 0, Hex 9, Save and Reset
10 scans	Programming Mode, Hex 6, Hex B, Hex 0, Hex A, Save and Reset
11 scans	Programming Mode, Hex 6, Hex B, Hex 0, Hex B, Save and Reset
12 scans	Programming Mode, Hex 6, Hex B, Hex 0, Hex C, Save and Reset
13 scans	Programming Mode, Hex 6, Hex B, Hex 0, Hex D, Save and Reset
14 scans	Programming Mode, Hex 6, Hex B, Hex 0, Hex E, Save and Reset
15 scans	Programming Mode, Hex 6, Hex B, Hex 0, Hex F, Save and Reset

24462

## Number of UPC/EAN Scans Required

Selection	Programming Tag Sequence
1 scan	Programming Mode, Hex 6, Hex B, Hex 3, Hex 1, Save and Reset
2 scans	Programming Mode, Hex 6, Hex B, Hex 3, Hex 2, Save and Reset
3 scans	Programming Mode, Hex 6, Hex B, Hex 3, Hex 3, Save and Reset
4 scans	Programming Mode, Hex 6, Hex B, Hex 3, Hex 4, Save and Reset

24463

## Number of Code 39 Scans Required

Selection	Programming Tag Sequence
1 scan	Programming Mode, Hex 6, Hex B, Hex 4, Hex 1, Save and Reset
2 scans	Programming Mode, Hex 6, Hex B, Hex 4, Hex 2, Save and Reset
3 scans	Programming Mode, Hex 6, Hex B, Hex 4, Hex 3, Save and Reset
4 scans	Programming Mode, Hex 6, Hex B, Hex 4, Hex 4, Save and Reset

24464

## Number of Code 128 Scans Required

Selection	Programming Tag Sequence
1 scan	Programming Mode, Hex 6, Hex B, Hex 7, Hex 1, Save and Reset
2 scans	Programming Mode, Hex 6, Hex B, Hex 7, Hex 2, Save and Reset
3 scans	Programming Mode, Hex 6, Hex B, Hex 7, Hex 3, Save and Reset
4 scans	Programming Mode, Hex 6, Hex B, Hex 7, Hex 4, Save and Reset

24466

## Number of Code 39 Overlaps Required

Selection	Programming Tag Sequence
1 overlap	Programming Mode, Hex 6, Hex B, Hex 9, Hex 1, Save and Reset
2 overlaps	Programming Mode, Hex 6, Hex B, Hex 9, Hex 2, Save and Reset
3 overlaps	Programming Mode, Hex 6, Hex B, Hex 9, Hex 3, Save and Reset
4 overlaps	Programming Mode, Hex 6, Hex B, Hex 9, Hex 4, Save and Reset

24529

## Number of Minimum Code 39 Characters in Code 39 Partial

Selection	Programming Tag Sequence
2 characters	Programming Mode, Hex 6, Hex B, Hex C, Hex 2, Save and Reset
3 characters	Programming Mode, Hex 6, Hex B, Hex C, Hex 3, Save and Reset
4 characters	Programming Mode, Hex 6, Hex B, Hex C, Hex 4, Save and Reset
5 characters	Programming Mode, Hex 6, Hex B, Hex C, Hex 5, Save and Reset
6 characters	Programming Mode, Hex 6, Hex B, Hex C, Hex 6, Save and Reset
7 characters	Programming Mode, Hex 6, Hex B, Hex C, Hex 7, Save and Reset
8 characters	Programming Mode, Hex 6, Hex B, Hex C, Hex 8, Save and Reset
9 characters	Programming Mode, Hex 6, Hex B, Hex C, Hex 9, Save and Reset

24531

## Number of Code 128 Overlaps Required

Selection	Programming Tag Sequence
1 overlap	Programming Mode, Hex 6, Hex B, Hex D, Hex 1, Save and Reset
2 overlaps	Programming Mode, Hex 6, Hex B, Hex D, Hex 2, Save and Reset
3 overlaps	Programming Mode, Hex 6, Hex B, Hex D, Hex 3, Save and Reset
4 overlaps	Programming Mode, Hex 6, Hex B, Hex D, Hex 4, Save and Reset

24532



## Number of Minimum Interleaved 2 of 5 Characters in Interleaved 2 of 5 Partial

Selection	Programming Tag Sequence
2 characters	Programming Mode, Hex 6, Hex B, Hex E, Hex 2, Save and Reset
3 characters	Programming Mode, Hex 6, Hex B, Hex E, Hex 3, Save and Reset
4 characters	Programming Mode, Hex 6, Hex B, Hex E, Hex 4, Save and Reset
5 characters	Programming Mode, Hex 6, Hex B, Hex E, Hex 5, Save and Reset
6 characters	Programming Mode, Hex 6, Hex B, Hex E, Hex 6, Save and Reset
7 characters	Programming Mode, Hex 6, Hex B, Hex E, Hex 7, Save and Reset
8 characters	Programming Mode, Hex 6, Hex B, Hex E, Hex 8, Save and Reset
9 characters	Programming Mode, Hex 6, Hex B, Hex E, Hex 9, Save and Reset

24533

## Number of Minimum Code 128 Characters in Code 128 Partial

Selection	Programming Tag Sequence	Setting
4 characters	Programming Mode, Hex 6, Hex B, Hex F, Hex 4, Save and Reset	
5 characters	Programming Mode, Hex 6, Hex B, Hex F, Hex 5, Save and Reset	
6 characters	Programming Mode, Hex 6, Hex B, Hex F, Hex 6, Save and Reset	
7 characters	Programming Mode, Hex 6, Hex B, Hex F, Hex 7, Save and Reset	
8 characters	Programming Mode, Hex 6, Hex B, Hex F, Hex 8, Save and Reset	
9 characters	Programming Mode, Hex 6, Hex B, Hex F, Hex 9, Save and Reset	

24534

## Command-type Disable

Selection	Programming Tag Sequence	Setting
Disable	Programming Mode, Hex 6, Hex 7, Hex 8, Save and Reset	Default
Enable	Programming Mode, Hex 6, Hex 7, Hex 9, Save and Reset	

24959

## Ignore RS232 Commands from Host Terminal

Selection	Programming Tag Sequence	Setting
Disable	Programming Mode, Hex 7, Hex 0, Hex A, Hex 0	Default
Enable	Programming Mode, Hex 7, Hex 0, Hex A, Hex 1	

24960

## Enable UPC NS5 Coupon

Selection	Programming Tag Sequence	Setting
Enable	Programming Mode, Hex 7, Hex 1, Hex C, Save and Reset	Default
Disable	Programming Mode, Hex 7, Hex 1, Hex D, Save and Reset	

24964

## GS1 DataBar AI 8110 coupons

### *GS1 DataBar 8110*

Selection	Programming Tag Sequence	Setting
Disable	Programming Mode, Hex 7, Hex 1, Hex 0, Save and Reset	Default
Enable	Programming Mode, Hex 7, Hex 1, Hex 1, Save and Reset	

27800

### *GS1 DataBar-E AI 8110*

Selection	Programming Tag Sequence	Setting
Disable	Programming Mode, Hex 7, Hex 1, Hex2, Save and Reset	Default
Enable	Programming Mode, Hex 7, Hex 1, Hex3, Save and Reset	

27801

## EAN-13 98 coupons

Selection	Programming Tag Sequence	Setting
Enable	Programming Mode, Hex 7, Hex 1, Hex 8, Save and Reset	Default
Disable	Programming Mode, Hex 7, Hex 1, Hex 9, Save and Reset	

24967

## EAN-13 99 coupons

Selection	Programming Tag Sequence	Setting
Enable	Programming Mode, Hex 7, Hex 1, Hex A, Save and Reset	Default
Disable	Programming Mode, Hex 7, Hex 1, Hex B, Save and Reset	

24968

## Expand E to EAN-13 Directly

Selection	Programming Tag Sequence	Setting
Disable	Programming Mode, Hex 4, Hex 7, Hex 6, Save and Reset	Default
Enable	Programming Mode, Hex 4, Hex 7, Hex 7, Save and Reset	

25336

## Checkpoint Interlock

Selection	Programming Tag Sequence	Setting
Set Checkpoint Interlock Polarity	Programming Mode, Hex 7, Hex F, Hex A,	Save and Reset Default
	Programming Mode, Hex 7, Hex F, Hex B,	Save and Reset

25685

## Scanner Power-On State

Selection	Programming Tag Sequence	Setting
Disable	Programming Mode, Hex 8, Hex 0, Hex 1,	Save and Reset
Enable	Programming Mode, Hex 8, Hex 0, Hex 0,	Save and Reset Default

27079

## ASCII Code Chart

00	NULL	10	DLE	20	SP	30	0	40	@	50	P	60		70	p
01	SOH	11	DC1	21	!	31	1	41	A	51	Q	61	a	71	q
02	STX	12	DC2	22	"	32	2	42	B	52	R	62	b	72	r
03	ETX	13	DC3	23	#	33	3	43	C	53	S	63	c	73	s
04	EOT	14	DC4	24	\$	34	4	44	D	54	T	64	d	74	t
05	ENQ	15	NAK	25	%	35	5	45	E	55	U	65	e	75	u
06	ACK	16	SYN	26	&	36	6	46	F	56	V	66	f	76	v
07	BEL	17	ETB	27	'	37	7	47	G	57	W	67	g	77	w
08	BS	18	CAN	28	(	38	8	48	H	58	X	68	h	78	x
09	HT	19	EM	29	)	39	9	49	I	59	Y	69	i	79	y
0A	LF	1A	SUB	2A	*	3A	:	4A	J	5A	Z	6A	j	7A	z
0B	VT	1B	ESC	2B	+	3B	;	4B	K	5B	[	6B	k	7B	{
0C	FF	1C	FS	2C	,	3C	<	4C	L	5C	\	6C	l	7C	
0D	CR	1D	GS	2D	-	3D	=	4D	M	5D	]	6D	m	7D	}
0E	S0	1E	RS	2E	.	3E	>	4E	N	5E	^	6E	n	7E	~
0F	S1	1F	US	2F	/	3F	?	4F	O	5F	_	6F	o	7F	DEL

R0040

## Special Programming

Some of the 7874 features require programming that is somewhat different than the normal programming. The following sections describe the Special Programming options.

### Set Current Parameters to Default Values

The 7874 comes from the factory with specific default values already determined for the various programming parameters. Sometimes other default values are desired. This function permits the current parameter settings to be stored as soft default values. When this is done, scanning the **Default** tag sets the parameters to these values rather than the factory defined values.

#### Enable Soft Defaults

Scan the following sequence of programming tags.

1. **Diagnostic Mode, Hex 5, and Hex E**—sets current parameters as soft defaults
2. **Program Mode, Hex 3, Hex 4, and Hex E**—enables Soft Default option
3. **Save and Reset**—saves the program change

One of three voice messages is given.

- "Set New Default Parameter Complete"—If any defaults were changed, followed by "Save and Reset Next"—to save the new soft default values
- "No Default Parameter Change"—If there are no changes to the current default parameters
- "Error Full Parameter Change Buffer"—If too many default changes are attempted. An error tone also sounds

#### Disable Soft Defaults

To have the **Default** tag set program parameters to factory defined values, disable the Soft Default option. Do this by scanning the following tags.

1. **Program Mode, Hex 3, Hex 4, and Hex 0**—disable Soft Default option
2. **Save and Reset**—saves the program change
3. **Default**—sets the program to default values

## Convert UPC-E Tags to EAN-13 Tags

UPC-E tags can be converted directly to EAN-13 tags. This function is only needed if UPC-A tags are not to be converted to EAN-13 tags. The default is to disable this function.

- Enable Converting UPC-E to EAN-13—**Program Mode, Hex 4, Hex 7, Hex 7, Save and Reset**
- Disable Converting UPC-E to EAN-13—**Program Mode, Hex 4, Hex 7, Hex 6, Save and Reset**

## Check Digits on Price Fields

UPC-A and EAN-13 barcodes which begin with a Number System 2 and contain either a 4 or 5 digit price or weight value. To increase the security of reading a price or weight from a bar code symbol, the Check Digit for these special fields is subject to additional scrutiny and mathematical calculations in addition to the standard check digit verification performed on every UPC bar code.

The basic principle of the Check Digit calculation is that each digit position in a price or weight field is assigned a weighing factor. Weighing factors are 2-, 3, 5+, and 5-. Each weighing factor affects the particular calculation for the position concerned. The detailed calculation and method used for calculating this weighing factor is described in the GS1 General Specifications, Section 3, of Version 7.1, specifically 3.A.1.2 Check Digit Calculation for Price/Weight Fields.

The scanner can be programmed to enforce this price check for 4 or 5 digit price tags.

**Note:** If the check digit is encoded incorrectly in the barcode, the scanner will NOT read it. It will be treated as if the bar code does not exist.

### Mandatory 4 Digit Price Check

Selection	Programming Tag Sequence	Setting
Disable	Programming Mode, Hex 3, Hex 3, Hex 6, Save and Reset	Default
Enable	Programming Mode, Hex 3, Hex 3, Hex 7, Save and Reset	

25363

### Mandatory 5 Digit Price Check

Selection	Programming Tag Sequence	Setting
Disable	Programming Mode, Hex 3, Hex 3, Hex E, Save and Reset	Default
Enable	Programming Mode, Hex 3, Hex 3, Hex F, Save and Reset	

25364

## Enable/Disable Code-128 Partial

When decoding Code 128 using partial scans, sometimes a Decode error is generated. However, several conditions must occur to cause the misread. If having problems reading Code 128 bar codes, try disabling partials.

- Disable Code 128 Partial—**Program Mode, Hex 1, Hex 7, Hex F, Hex 0, and Save and Reset**
- Enable Code 128 Partial—**Program Mode, Hex 1, Hex 7, Hex F, Hex 1, and Save and Reset**

## Good Read Tone

The Good Read tone is composed of three elements: volume, frequency (tone), and length. Three different presets, each with a different combination of volume, tone, and tone length settings, are available that permit the Good Read tone to be set by scanning just one sequence of Programming Tags. Preset 0 is the default for this parameter.

**Preset 0**  
 Programming Mode  
 Hex 4  
 Hex 3  
 Hex 0  
 Save and Reset

Volume Tone Length

**Preset 1**  
 Programming Mode  
 Hex 4  
 Hex 3  
 Hex 1  
 Save and Reset

Volume Tone Length

**Preset 2**  
 Programming Mode  
 Hex 4  
 Hex 3  
 Hex 2  
 Save and Reset

Volume Tone Length

## GS1 DataBar

GS1 Databar, formerly Reduced Space Symbology (RSS) permits more data to be recorded in a smaller physical space. This is accomplished by encoding the data in large symbol characters rather than encoding each data character separately. Also, no quiet zone is required around the symbols. The 7874 can read four types of GS1 Databar barcodes.

### GS1 Databar

GS1 Databar, formerly Reduced Space Symbology (RSS) permits more data to be recorded in a smaller physical space. This is accomplished by encoding the data in large symbol characters rather than encoding each data character separately. Also, no quiet zone is required around the symbols. The 7874 can read four types of GS1 Databar barcodes.

### GS1 Databar-14

GS1 Databar-14 is a linear symbology that encodes 14 UCC/EAN digits. This structure provides four segments that can be scanned and decoded separately, then reconstructed. The total symbol contains 96 modules combined into 46 elements (bars and spaces).



0100012345678905

19254

### GS1 Databar-14 Stacked

GS1 Databar-14 Stacked is a 2-row format. The bottom row is higher than the top row and the two are separated with a separator pattern. The stacked format is used when not enough linear space is available. An example use is marking produce in a grocery store.



0100991234567899

19255

### GS1 Databar–Expanded

GS1 Databar–Expanded is a variable length linear symbology. It can encode 74 numeric or 41 alpha characters. RSS Expanded can be scanned and decoded in up to 22 segments and then reconstructed



9987 6543 2101 2345 6789 8888

19256

### GS1 Databar–Expanded Stacked

GS1 Databar–Expanded Stacked is similar to GS1 Databar–14 Stacked except it uses the GS1 Databar–Expanded format for creating the symbol.



0192 1234 5698 7457 3202 0000 9939 0200 296

19257

### Enable/Disable GS1 DataBar

GS1 DataBar permits more data to be recorded in a smaller physical space. The 7874 can be programmed to read GS1 DataBar tags. When programming the GS1 DataBar feature, the programming tags must be the first tags scanned after applying power to the 7874.

- Enable—**Program Mode, Hex 1, Hex 8, Hex A, Hex 3, Save and Reset.**
- Disable—**Program Mode, Hex 1, Hex 8, Hex A, Hex 0, Save and Reset.**

### Send GS1 DataBar–14 as EAN–13 Data

When enabled, the scanner sends the last 13 digits of the GS1 DataBar–14 data to the host terminal. The **Default** tag does not change this parameter.

- Enable—**Program Mode, Hex 6, Hex 0, Hex 5, and Save and Reset.**
- Disable—**Program Mode, Hex 6, Hex 0, Hex 4, and Save and Reset.**



## Terminal Coupon Interface Parameters

Certain parameters must be set to permit the unit to transmit coupon data to the host terminal. These are in addition to the general parameters that are required for other scanner functions.

**Note:** Selection of optional Add-On bar codes may require additional programming.

To set the Coupon Interface Parameters, perform a series of steps in a designated order. First, set the Terminal Coupon Select 1 parameters, and then set the Terminal Coupon Select 2 parameters. Select one of the parameters below to display the procedure.

### Terminal Coupon Select 1

1. Scan the **Program Mode** tag.
2. Scan the **Hex 3** and **Hex 8** tags to select this parameter.
3. Scan a **Hex 0** through **Hex F** tag to set a Coupon Select 1 parameter.

Coupon Select 1 Parameter	Disable	Enable
Coupon with P5 optional	Hex 0	Hex 1
Coupon with 128 Add-On optional	Hex 2	Hex 3
Coupon with 128 Add-On mandatory	Hex 4	Hex 5

4. Scan the **Save and Reset** tag to save the program (required).

**Note:** Repeat steps 1 through 4 to set the second Coupon Select 1 parameter.

### *Suggested Programming Sequence*

- Program Mode
- Hex 3 and Hex 8
- Hex 1
- Save and Reset
- Program Mode
- Hex 3 and Hex 8
- Hex 3

Scan **Program Mode**, **Hex 1**, **Hex 7**, **Hex F**, **Hex 0**, and **Save and Reset** tags to complete the programming function.

**Note:** Scanning the **Default** tag resets all options.

### Terminal Coupon Select 2

1. Scan the **Program Mode** tag.
2. Scan the **Hex 3** and **Hex D** tags to select this parameter.
3. Scan a **Hex 0** through **Hex 7** tag to set a Coupon Select 2 parameter:

Coupon Select 2 Parameter	Disable	Enable
Coupon and P5 or 128 optional (EAN-99)	Hex 0	Hex 1
Coupon and 128 mandatory (EAN-99)	Hex 2	Hex 3
Markdown Tone	Hex 4	Hex 5
Early Tone for Optional Add-On	Hex 6	Hex 7

4. Scan the **Save and Reset** tag to save the program.  
**Note:** Repeat steps 1 through 4 to set the other option, if needed.
5. Scan **Program Mode**, **Hex 1**, **Hex 7**, **Hex F**, **Hex 0**, and **Save and Reset** tags to complete the programming function.

**Note:** Scanning the **Default** tag resets all options.

## Voice Messages—Enable/Disable

The 7874 uses voice messages for diagnostics, and clerk messages. If voice messages are enabled, they are heard at the appropriate time; if they are disabled, the beep tones are heard instead. To enable or disable voice messages, scan the following sequence of programming tags. These tags must be the first tags scanned after applying power to the unit.

#### *All Voice Messages Off/On*

1. **Program Mode**
2. **Hex 3**
3. **Hex 3**
4. **Hex D**
5. **Save and Reset**

#### *Clerk Messages On*

1. **Program Mode**
2. **Hex 3**
3. **Hex 3**
4. **Hex 1**
5. **Save and Reset**

*Clerk Messages Off*

1. **Program Mode**
2. **Hex 3**
3. **Hex 3**
4. **Hex 0**
5. **Save and Reset**

**Note:** Because the clerk messages are a subset of the Voice Messages, disabling all voice messages disables the clerk messages also. All Voice Messages must be enabled for the Clerk Messages to be enabled.

Following are the three clerk messages.

- Scale failed, clean under scale deck
- Scale failed, code 5, clean under scale deck
  - Next, do scale calibration
  - Next, change scale
- Scale failed, code 4
  - Stop checkstand mechanical vibration
  - Next, change scale

## Voice Volume

To change the volume of the voice (speech) on the 7874, scan the following tags.

- **Program Mode, Hex 5, Hex 7, Hex 0, Save and Reset**—Maximum voice volume
- **Program Mode, Hex 5, Hex 7, Hex 1, Save and Reset**—High voice volume
- **Program Mode, Hex 5, Hex 7, Hex 2, Save and Reset**—Medium voice volume
- **Program Mode, Hex 5, Hex 7, Hex 3, Save and Reset**—Minimum voice volume

## Volume Adjust Button

The Volume Adjust Button on the Operator Display Panel changes the Good Read tone volume and frequency (tone). This button can be programmed to work in various ways.

## Volume Levels

There are eight standard volume settings in the 7874. However, there is a programming sequence which activates eleven. This gives the operator greater flexibility in selecting the appropriate volume of the Good read Tone. This parameter does not have a default value, however, the 7874 is shipped from the factory with this parameter disabled. The default setting of the 7874 is eight volume levels.

- Enable—**Program Mode, Hex 4, Hex 2, Hex 5, and Save and Reset**
- Disable—**Program Mode, Hex 4, Hex 2, Hex 4, and Save and Reset**

## Enable/Disable Volume Adjust Button

Through programming, the Volume Adjust button can be enabled or disabled. If disabled, the Good Read tone volume and tone are set using the various programming tags; and pressing the button does not change the Good Read tone. If the Volume Adjust Button is disabled, be sure to set the volume, tone, and tone length to the desired settings first.

**Note:** Scanning the **Default** tag enables the Volume Adjust Button.

- Enable—**Program Mode, Hex 3, Hex E, Hex 1, and Save and Reset**
- Disable—**Program Mode, Hex 3, Hex E, Hex 0, and Save and Reset**

### *Enable Volume Adjust Button*

To enable the Volume Adjust button, scan the following sequence of programming tags. These tags must scanned first after applying power to the 7874.

1. **Program Mode**—puts scanner in the programming mode
2. **Hex 3, Hex E, Hex 1**—enables the Volume Adjust button
3. **Save and Reset**—stores the enabled setting, and then resets the scanner

### *Disable Volume Adjust Button*

To disable the Volume Adjust Button, scan the following sequence of programming tags. These tags must scanned first after applying power to the 7874. This sequence sets the Good Read tone frequency (tone), length, and volume.

1. **Program Mode**—starts the scanner in the programming mode.
2. **Hex 1, Hex 1**—sends programming to the Good Read Tone parameters
3. **Hex A, Hex 1**—turns on the Good Read tone in case it was previously turned off
4. **Hex B**—repeatedly scan this tag until you reach the desired tone frequency (tone)
5. **Hex C**—repeatedly scan this tag until you reach the desired tone length
6. **Hex D**—repeatedly scan this tag until you reach the desired tone volume
7. **End**—Sends programming back to Program Mode

8. **Hex 3, Hex E**, then **Hex 0**—Disables the Volume Adjust button
9. **Save and Reset** tag—Stores the Good Read tone and Volume Adjust button settings, and then resets the scanner

### Single Volume Adjust Bar Code

There is a single Volume Adjustment bar code in the Programming Tag booklet, NCR Scanner Programming Tags (BST0-2121-74) available at [www.info.ncr.com](http://www.info.ncr.com). (The tags are also included in Appendix A of this document.) This bar code functions exactly in the same manner as pressing the volume adjust button, except the disable Volume Adjust Button sequence has no effect when reading this bar code. The volume obtained by using this bar code is temporary. That is, if used outside a Program Mode/Save & Reset sequence, the original programmed volume level will return when the scanner is power cycled. But if the Volume Adjustment bar code is scanned within a Program Mode/Save&Reset sequence, or the Reset bar code from the booklet is scanned, the volume is saved as if it had been changed by using Worksheet 11.

## Firmware Flashing

Firmware flashing permits updates to be installed to the scanner firmware without replacing the actual chip on the Digital Board. The 7874 must be connected to a PC or host terminal through an RS232 cable or USB cable. Also, the PC or host terminal must contain the NCR RealPOS Scanner Tool Suite and the new scanner firmware file.

Firmware flashing may also be done using a USB flash drive. Refer to the *NCR RealPOS Scanner Flash Drive Support* section below for more information.

## Obtaining the Utility and New Firmware

New firmware for the 7874 is available on the NCR web site. It is flashed to the 7874 using the NCR RealPOS Scanner Tool Suite. No version of the 7874 scanner will use the older EasyFlash utility.

### Acquiring and Installing the RealPOS Scanner Flash Tool for Windows

1. Go to NCR website ([www.ncr.com](http://www.ncr.com)), and click on **Support** in the topics banner at the top of the page. Select **Drivers and Patches** → **Retail Scanner**.
2. Download the RealPOS Scanner Flash Tool and put it in a temporary directory on your hard drive, or you can install the tool directly from the website.

## RealPOS Scanner FLASH Tool for Windows (all SA and PXA Scanners)

(Pushes firmware, EEPROM, foreign languages, and WAV files into the scanner; pulls EEPROM.)

**PLEASE NOTE:** This NEW version will place a shortcut on your desktop called "RealScan FLASH Tool".

Release Number	Release Date	Download
3.0.0.6 Build 49	11 Nov 2008	<a href="#">Readme.rtf</a>
3.0.0.6 Build 49	11 Nov 2008	<a href="#">RealScan FLASH Tool, Free Version for Windows</a> (GUI Installer)
3.0.0.6 Build 49	11 Nov 2008	<a href="#">RealScan FLASH Tool, Trial Enterprise Version for Windows</a> (GUI Installer - no Flash tag required, trial good for 90 DAYS ONLY)

**Note:** If you run the installer from website, a message will display saying "The publisher could not be verified. Are you sure you want to run this software", Select **Run** to continue.

3. Run the NCR Flash Tool installer.

A GUI install wizard will display. Follow the **Next** button, and accept the User Agreement. Allow for a FULL install (default), and select **Next**, then select **Install** to start the installation.

Select **Exit** when installation is finished.

**Note:** The NCR Flash Tool and all its components will be located at C:\Program Files\NCR\RealScan\NCRSFash directory, and a shortcut to the Flash Tool application will be placed on your desktop.

## Acquiring Firmware

Download the desired firmware from the same website. There will be a list of the currently released firmware and several older versions. The following is an example.

### PXA Scanner Firmware

(7874-3xxx/4xxx/5xxx) (7878-1xxx/2xxx) (7884-1xxx)

#### Firmware Versions for the 7874 (PXA) Scanner

Part Number	Release Date	Download
497-0461146	01 Jul 2008	<a href="#">0461146.zip</a> - GCA
497-0459425	18 Feb 2008	<a href="#">0459425.zip</a> - ICI

#### Firmware Versions for the 7878 (PXA) Scanner

Part Number	Release Date	Download
497-0461765	21 Oct 2008	<a href="#">0461765.zip</a>
497-0455729	27 Aug 2007	<a href="#">0455729.zip</a>
497-0455089	07 Jul 2007	<a href="#">0455089.zip</a> - GCA
497-0454779	04 Jun 2007	<a href="#">0454779.zip</a> - ICI

#### Firmware Versions for the 7884 (PXA) Scanner

Part Number	Release Date	Download
497-0460386	25 Sep 2008	<a href="#">0460386.zip</a>
497-0459699	26 Mar 2008	<a href="#">0459699.zip</a> - ICI

Download the desired firmware version into the C:\Program Files\NCR\RealScan\NCRSFash directory and extract the file to the same directory.

**Note:** The file extracted will be the actual firmware file with a .bin extension. This is the file that is flashed into the scanner. You cannot flash a .zip file into any scanner.

## Identifying Firmware Version

To identify the firmware already in the scanner, scan the **Diagnostic Mode, Hex 4**, and **Hex A** programming tags. These must be the first tags scanned after applying power to the unit. The 7874 gives a voice message containing the 497-xxxxxxx number of its firmware.

## Firmware Flashing Procedure

Perform the following procedure to flash firmware on the 7874:

1. Apply power to the 7874.
2. Connect the scanner to the host terminal using an RS232 cable or USB cable appropriate for 7874 scanner. The RS232 cable is part number 497-0300422 (1416-C019-004), and the USB cable is 497-0445079 (1432-C158-0040).

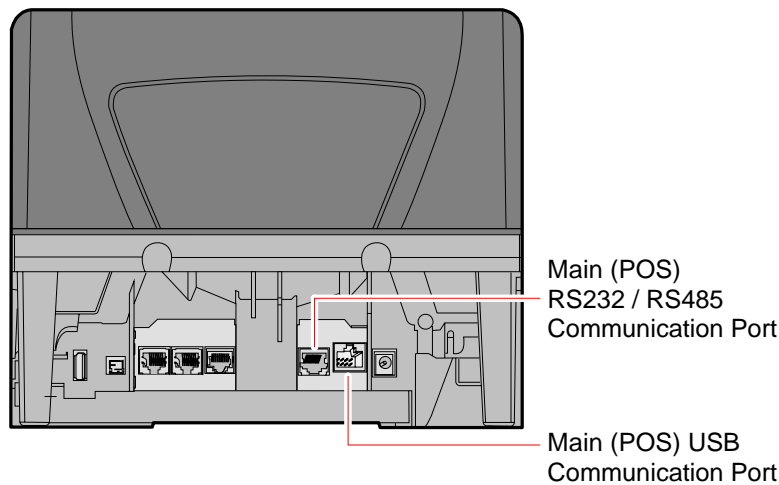

25508

3. Run the NCR Flash Tool.

4. Port settings must be configured first before flashing firmware to the scanner. Select **Port Settings** in the main window and select the **Modify INI** button.

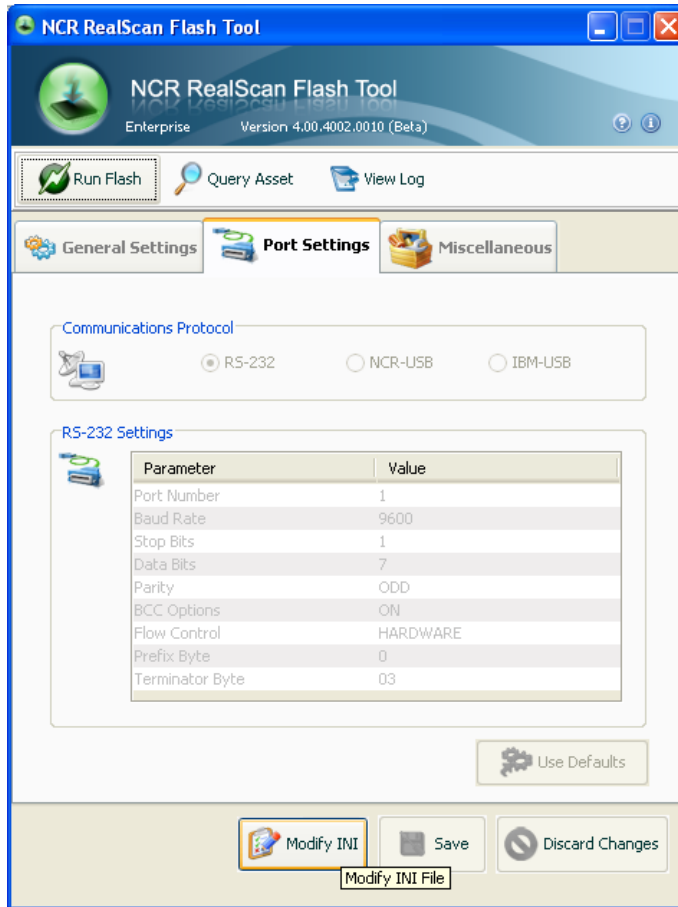

5. Select one of the radio buttons under the Communications Protocol Group within the Port Settings tab. For RS-232 communication protocol, you can configure more settings under the RS-232 Settings group. Right-click on one of the cells in the table to either change the parameter value or restore it to its default value.

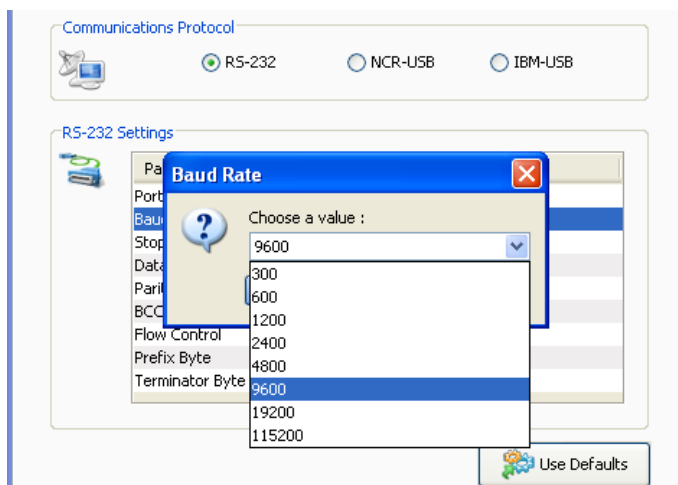



6. Select **Save** after making changes to the settings.

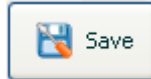

7. Select **Use Defaults** if default settings are preferred. A message box will display informing that all settings will be set to default. Select **Yes** to confirm.

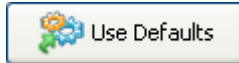

8. After configuring the necessary port settings, choose the scanner you want to flash the firmware to.

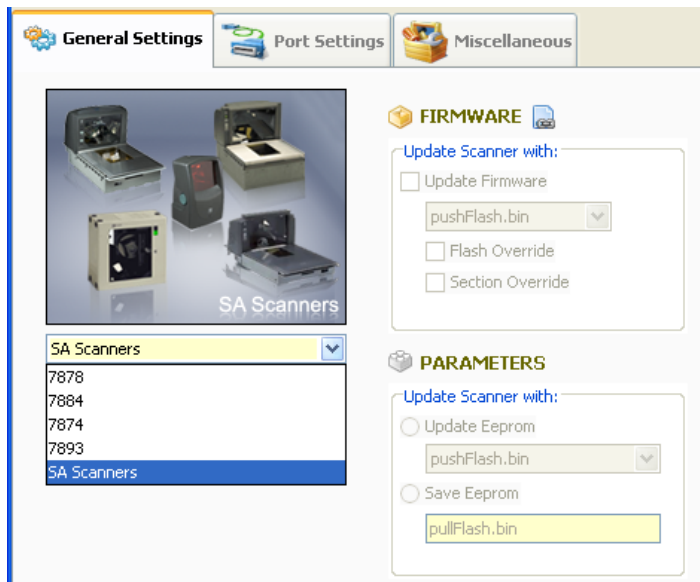

9. Select **Modify INI** after a scanner model has been chosen. Select the **Update Firmware** checkbox and choose the firmware BIN file you want to flash to the scanner. For your preference you may enable Flash Override and Section Override by selecting their checkboxes. Select **Save** to save and apply these settings.

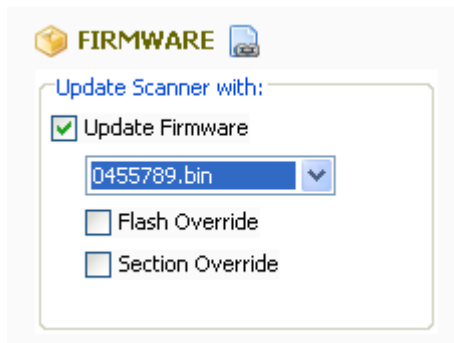

10. Select **Run Flash** from the main toolbar to start flashing the firmware to the scanner.



11. The application will initialize communication with the scanner in the port you have specified in the settings. When initialization is successful, the following window will display and show the progress of the flashing process.

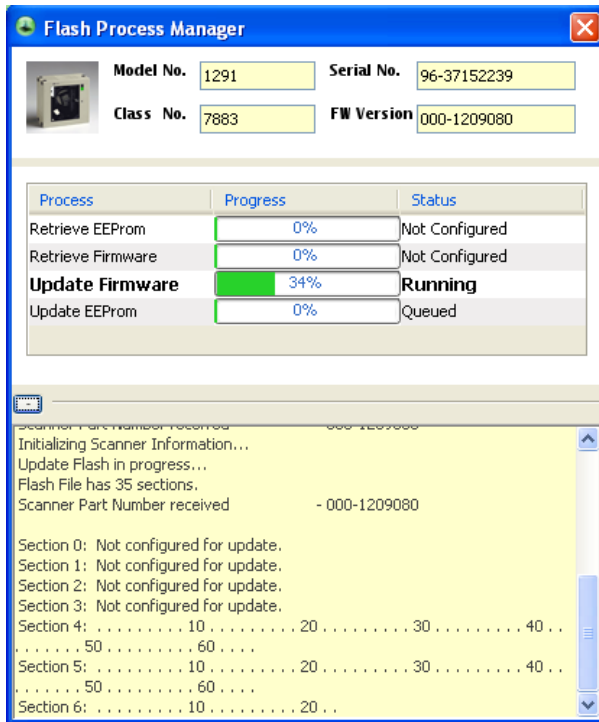

12. Exit the NCR Flash Tool application and disconnect the scanner from the host terminal once firmware flashing is finished.

## NCR RealPOS Scanner Flash Drive Support

The 7874 supports a flash drive to provide convenient and economic means of scanner service upgrades and initial installations. The flash drive support capabilities are similar to the capabilities currently provided by the scanner remote flash update and configuration tools NCR RealPOS Scanner Flash Tool. The major difference being that the required scanner support files will exist on the flash drive rather than on a PC, laptop, or back office controller which requires a transfer to the scanner over a cable.

Servicing or installing a scanner by flash drive is not a remote operation. A technician will be needed on-site to attach the flash drive to the scanner. A flash drive firmware upgrade is the fastest available means for upgrading the firmware of a scanner.

The scanner flash drive support files includes an INI file (created by the NCR RealPOS Scanner Flash Drive Prep Tool) that informs the scanner what tasks are to be performed, a firmware flash file for upgrading a scanner to a particular version, and a configuration file to configure a scanner for a particular end-user.

The scanner flash drive support files will be downloaded to the flash drive using the internet at the site currently used to download flash update files and tools (excluding the configuration file which is customer specific).

The following are the brands of flash drives (memory sticks, thumb drives, flash keys, jump drives) that have been tested by NCR.

Service Tool: Imation 1 GB, 603-9014783

Other Drives tested (but not guaranteed) by NCR:

- Memorex USB 2.0 Traveldrive 512MB
- Memorex USB 2.0 Traveldrive 1GB
- Lexar Jumpdrive JDS128 128 MB
- SanDisk Cruzer Micro 2 GB
- SanDisk Titanium 4 GB
- Kingston DataTraveler 1 GB
- Transcend JetFlash 2 GB
- Imation 1GB
- SanDisk Cruzer Micro 2 GB
- NCR 603-9014783 Flash drive (1GB, Imation Pivot model 18408)
- PQI 2GB
- Kingston DataTraveler 1GB
- Transcend JetFlash 2GB
- Kingston MicroSD w/ adapter 512MB

## NCR RealPOS Scanner Flash Drive Prep Tool

In order to minimize the need for a PC at the scanner site, The Flash Drive Prep Tool preps a flash drive so that the scanner could understand its contents and performs the tasks defined inside the device prepared by the host terminal software. This flash drive could then be taken to each scanner to perform its tasks without changing anything on the flash drive in between scanners.

All of the processes involved in setting communication parameters and running applications is replaced by a single flash drive properly configured by the NCR Flash Drive Manager application. The application provides a user interface that displays the options the user can select for their scanners and then prepare the flash drive accordingly.

### Flash Drive Prep Tool Installation

To install the flash drive manager, perform the following procedure.

1. Download the Flash Drive Prep Tool from the NCR website: [www.ncr.com](http://www.ncr.com)
2. Select `setup.exe` to run the installer. The following extraction wizard window displays.



3. Select **Continue** to start extracting the setup files.

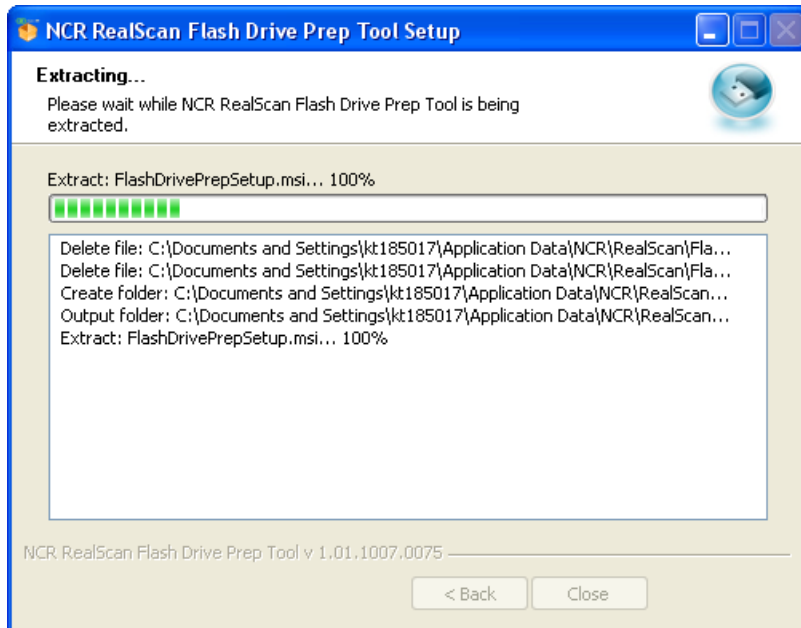

4. After the progress bar completes, the following window displays.

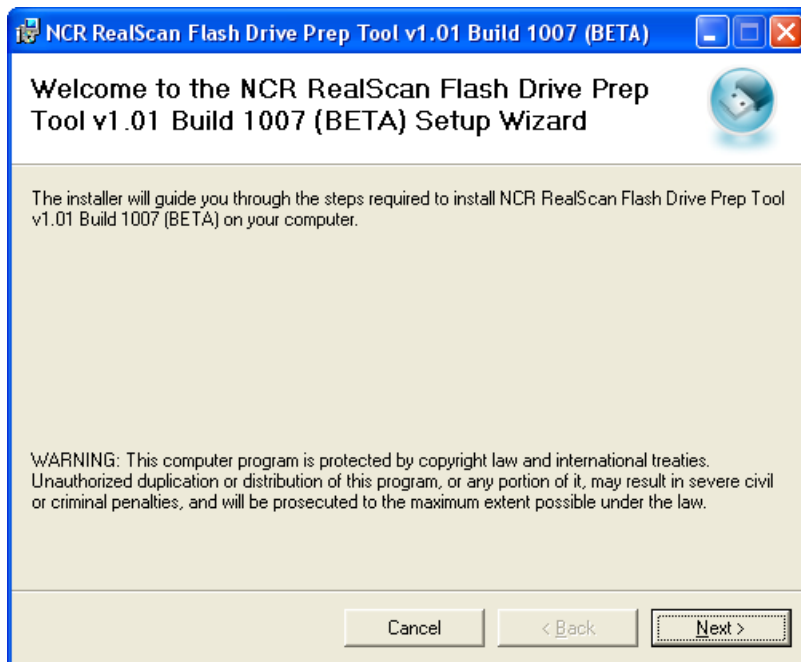

5. Select **Next**. The following window displays.

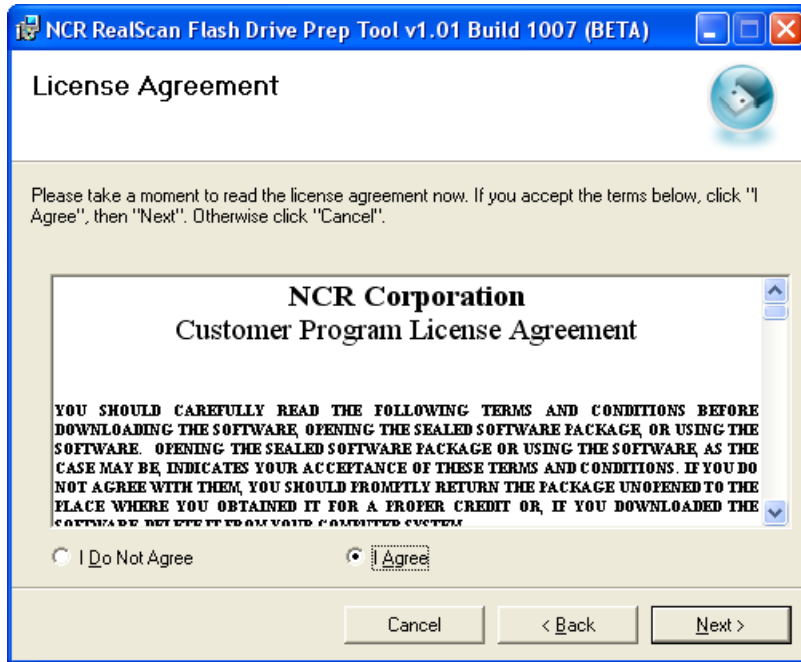

6. Select **I Agree** and select **Next**. The following window displays.

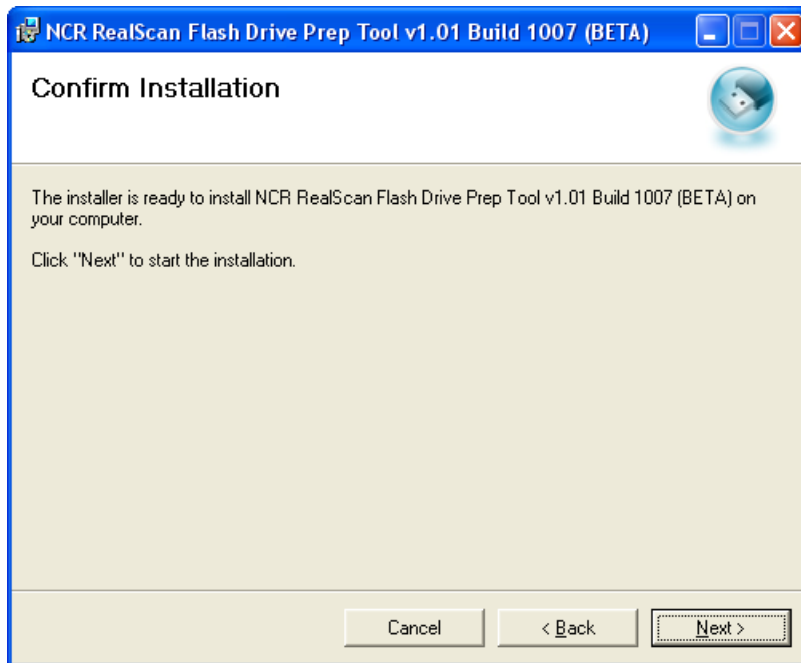

7. Select **Next** to continue. The Flash Drive Prep Tool installs and the following window displays after completing the installation.

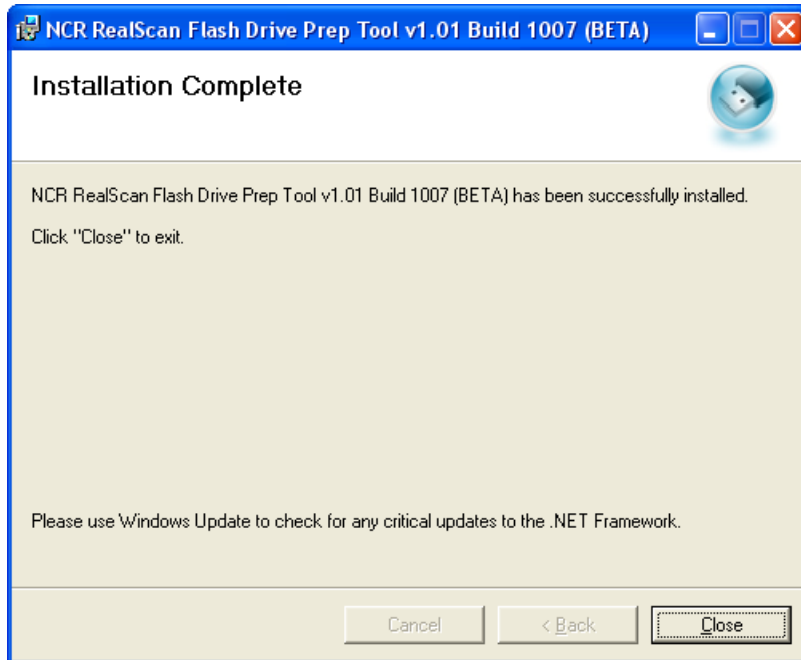

8. Select **Close** to exit.

The installer places an icon on the desktop. The following is a sample image of the icon.



The following window displays after selecting the flash drive prep tool icon.

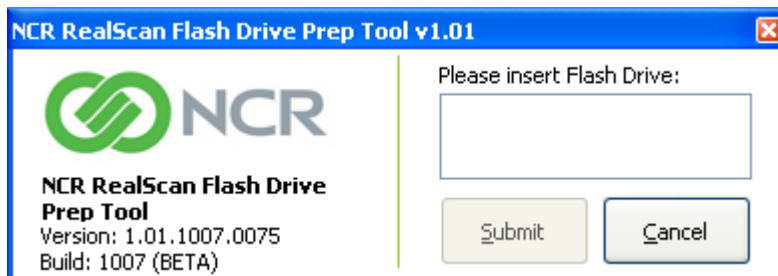

The application automatically detects the flash drive upon inserting it in the USB drive. Select **Submit** to continue.

## NCR RealPOS Scanner Flash Drive Prep Tool Functions

The following are the various functions in preparing a flash drive using the Flash Drive Prep Tool:

### Diagnostic Download or Memory Dump

This function provides diagnostic information (in ASCII text) that is typically used by the Firmware Engineering group when analyzing scanner problem.

1. Select the Flash Drive Prep Tool icon. The following window displays.

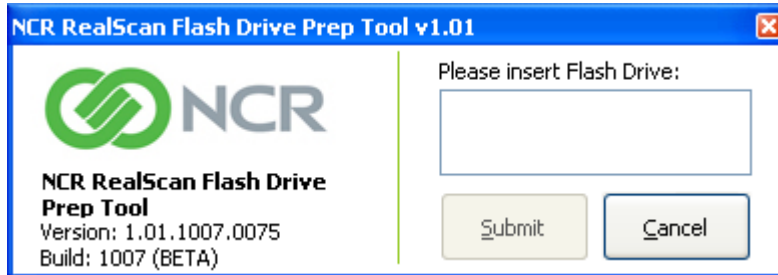

2. Insert the flash drive to be used. The application detects the flash drive installed.
3. Select **Submit**. The following window displays.

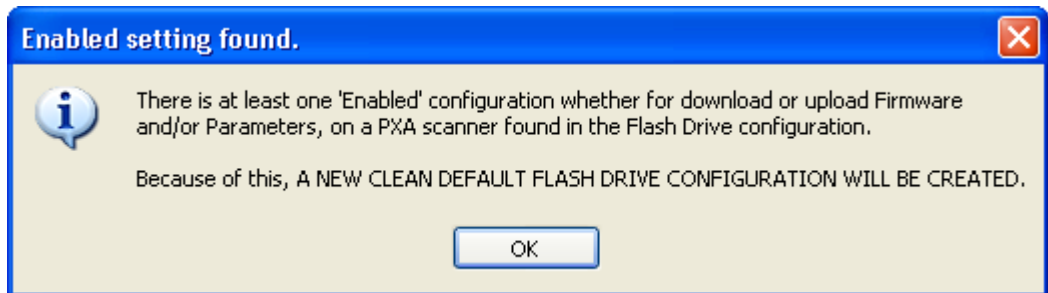



4. Select **OK**. The following window displays.

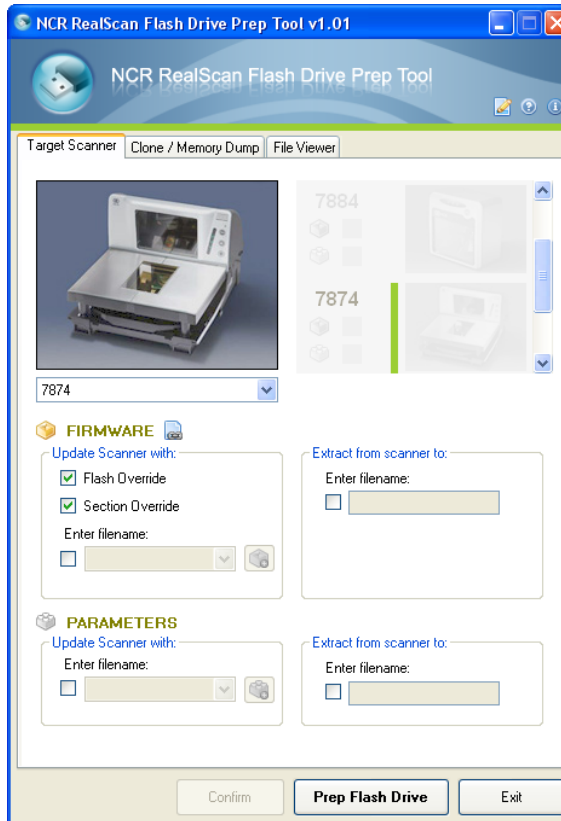

5. On the **Target Scanner** tab, select **7874** as the target scanner.
6. On the **Clone/Memory Dump** tab select the **Memory Dump** checkbox under the **Dumps** groupbox.

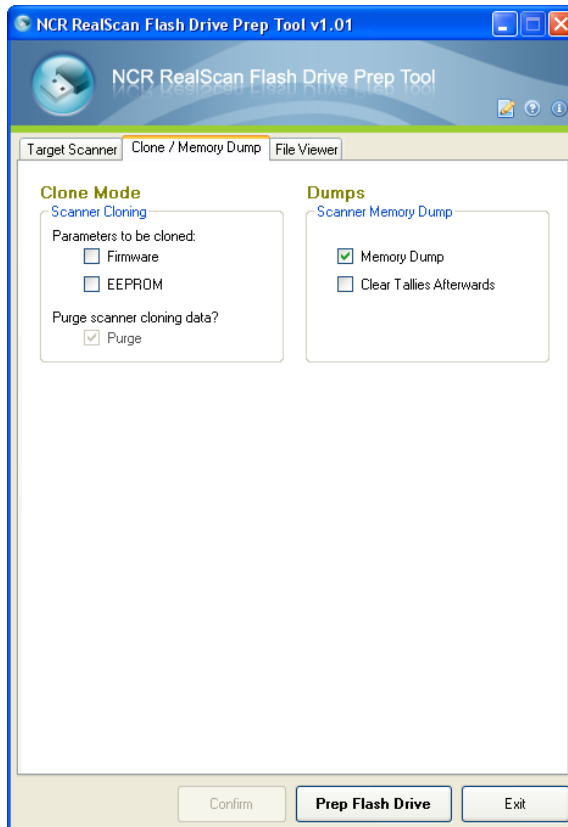

7. Select the **Prep Flash Drive** button. The application then preps the flash drive. The following message box displays after a successful flash drive prep.

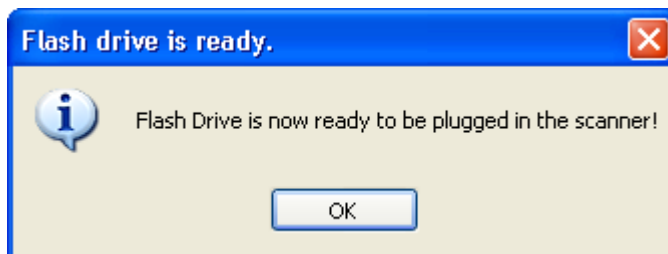

8. Right-click the **Safely Remove Hardware** icon on the system tray to safely remove the flash drive. A Safe to Remove Hardware balloon message displays near the system tray.

The application preps the flash drive plugged-in. A message box appears if it has successfully prepped the flash drive or not.

9. Plug the flash drive in the scanner's USB peripheral port.

The scanner gives off a triple beep of ascending frequency, which indicates that the USB peripheral port recognized the flash drive and was able to enumerate. The triple beep sounds off regardless of the contents of the flash drive. If the scanner fails to give off the triple beep, this indicates a USB peripheral port failure or the USB peripheral port was not able to communicate with the flash drive.

The scanner sounds off a low frequency triple beep, which indicates that the flash drive can now be safely removed.

10. Unplug the Flash drive from the scanner's USB peripheral port.

A descending triple beep sounds off., which indicates a successful shutdown of the flash drive's firmware.

### Parameters Upload

This function uploads the scanner configuration from the scanner to the flash drive.

1. Select the Flash Drive Prep Tool icon. The following window displays.

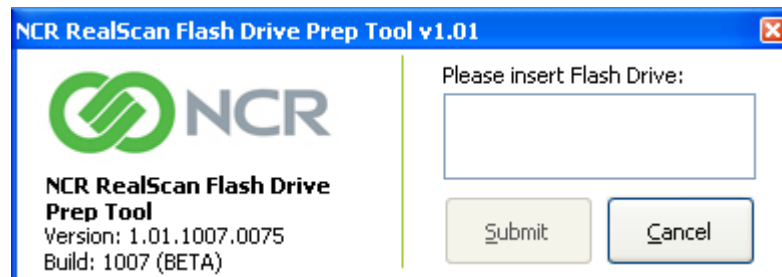

2. Insert the flash drive to be used. The application automatically detects the flash drive installed.

3. Select **Submit**. The following window displays.

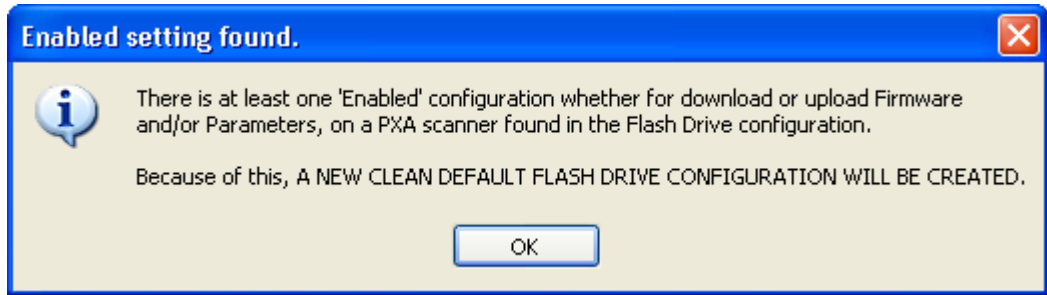

4. Select **OK**. The following window displays.

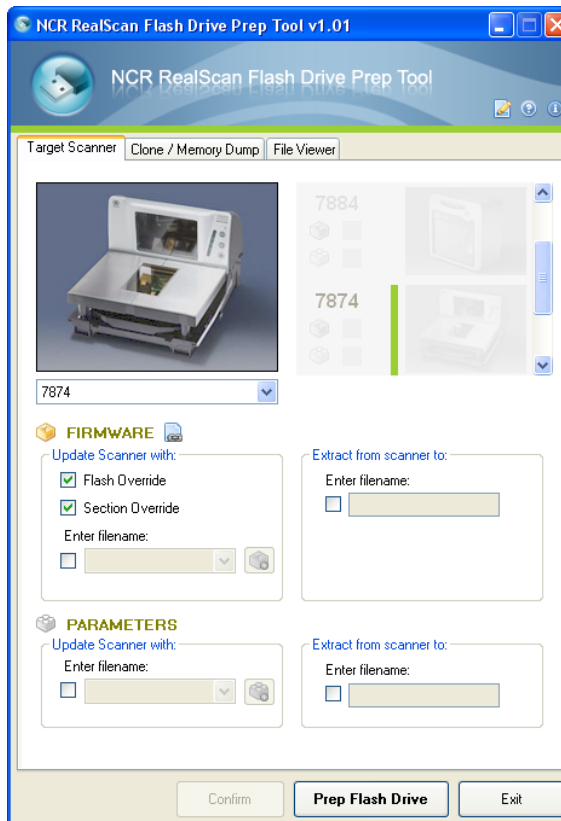

5. On the **Target Scanner** tab, select **7874** as the target scanner.
6. On the **PARAMETERS** groupbox, select the **Update scanner with:** checkbox.
7. Select the EEPROM from the dropdown menu.
8. Select the **Prep Flash Drive** button. The application then preps the flash drive. The following message box displays after a successful flash drive prep.

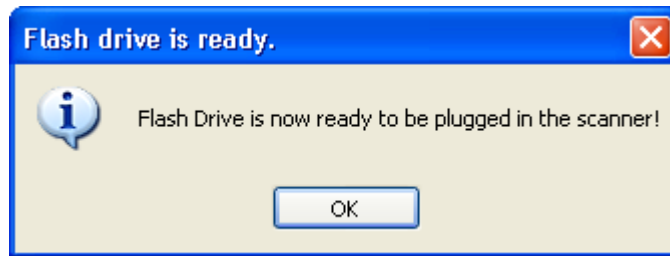

The **Down** arrow of the 2nd line in the Scanner Configuration Preview Panel under 7874 highlights.



9. Right-click the **Safely Remove Hardware** icon on the system tray to safely remove the flash drive. A Safe to Remove Hardware balloon message displays near the system tray.
10. Plug the flash drive to the scanner's USB peripheral port.

The scanner gives off a triple beep of ascending frequency, which indicates that the USB peripheral port recognized the flash drive and was able to enumerate. The triple beep sounds off regardless of the contents of the flash drive. If the scanner fails to give off the triple beep, this indicates a USB peripheral port failure or the USB peripheral port was not able to communicate with the flash drive.

The scanner then sounds off a low frequency triple beep, which indicates that the flash drive can be safely removed.

11. Unplug the Flash drive from the scanner's USB peripheral port.

A descending triple beep is sounded, which indicates a successful shutdown of the flash drive's firmware.

The EEPROM binary file (with a filename specified on step 3) must be present in the flash drive's root directory.

## Parameters Download

This function downloads the scanner configuration from the flash drive to the scanner. This is similar with the Flash tool except that the EEPROM image comes from the flash drive instead of from the PC.

1. Select the Flash Drive Prep Tool icon. The following window displays.

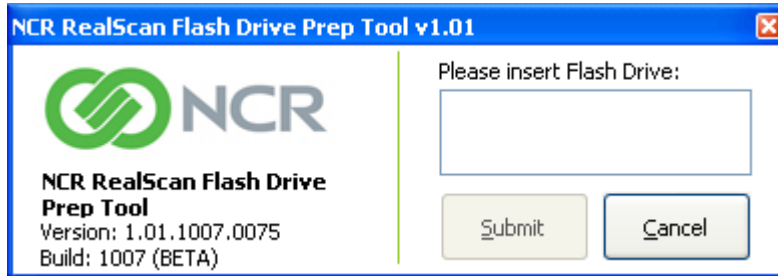

2. Insert the flash drive to be used. The application automatically detects the flash drive installed.
3. Select **Submit**. The following window displays.

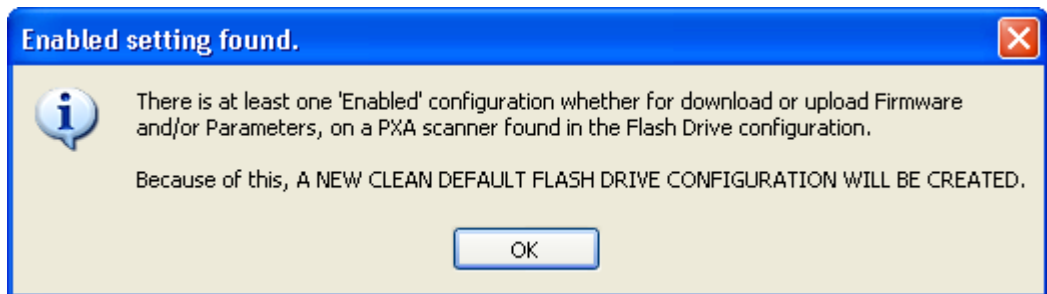

4. Select **OK**. The following window displays.



5. On the **Target Scanner** tab, select **7874** as the target scanner.
6. On the **PARAMETERS** groupbox, select the **Extract from scanner to:** checkbox.
7. Enter a filename. Ensure that the filename must have a `.bin` file extension or else an error exclamation symbol displays beside the textbox. The **Prep Flash Drive** button is also disabled if an incorrect filename is entered.

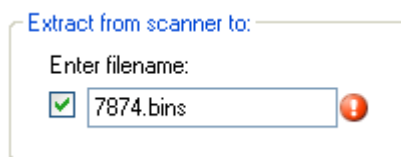

The following is a sample filename with the correct file extension.

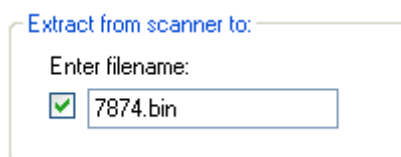

8. Select the **Prep Flash Drive** button. The application then preps the flash drive. The following message box displays after a successful flash drive prep.

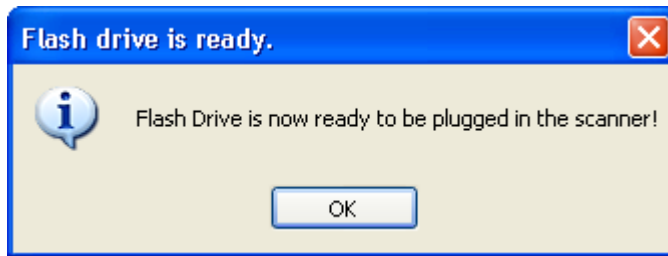

The **Up** arrow of the 2nd line in the Scanner Configuration Preview Panel under 7874 highlights.



9. Right-click the **Safely Remove Hardware** icon on the system tray to safely remove the flash drive. A Safe to Remove Hardware balloon message displays near the system tray.
10. Plug the flash drive in the scanner's USB peripheral port.

The scanner gives off a triple beep of ascending frequency, which indicates that the USB peripheral port recognized the flash drive and was able to enumerate. The triple beep sounds off regardless of the contents of the flash drive. If the scanner fails to give off the triple beep, this indicates a USB peripheral port failure or the USB peripheral port was not able to communicate with the flash drive.

The scanner then speaks "Load program in 3 seconds...2...1...0..." then the scanner resets.

A triple beep of ascending frequency follows. The scanner then sounds off a low frequency triple beep, which indicates that the flash drive can be safely removed.

Unplug the Flash drive from the scanner's USB peripheral port.



## Firmware Upload

This function uploads the scanner firmware from the scanner to the flash drive.

1. Select the Flash Drive Prep Tool icon. The following window displays.

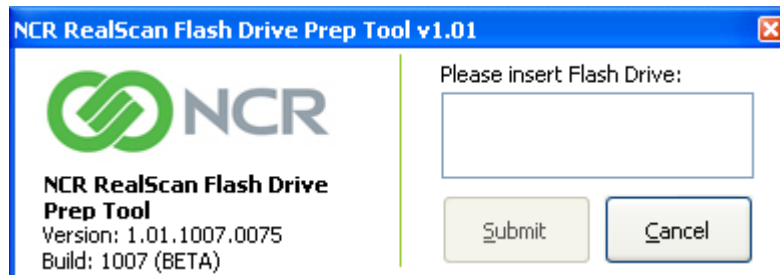

2. Insert the flash drive to be used. The application automatically detects the flash drive installed.
3. Select **Submit**. The following window displays.

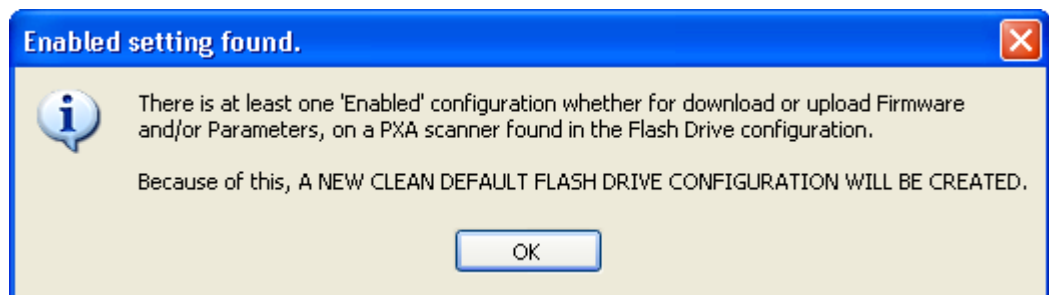

4. Select **OK**. The following window displays.

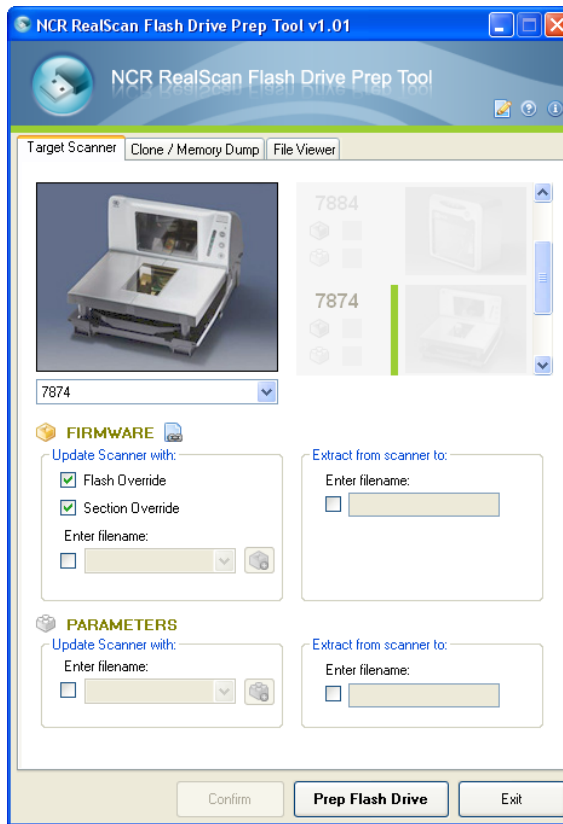

5. On the **Target Scanner** tab, select **7874**.
6. On the **FIRMWARE** groupbox, select the **Extract from scanner to:** checkbox.
7. Enter a filename. Ensure that the filename must have a `.bin` file extension or else an error exclamation symbol displays beside the textbox. The **Prep Flash Drive** button is also disabled if an incorrect filename is entered.

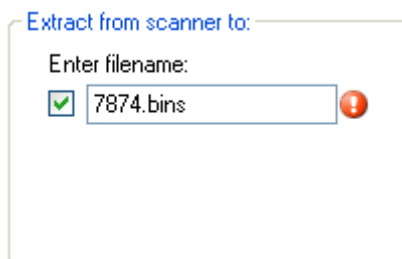

The following is a sample filename with the correct file extension.

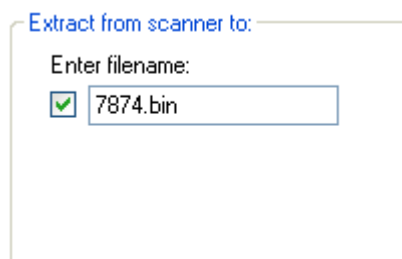

8. Select the **Prep Flash Drive** button. The application then preps the flash drive. The following message box displays after a successful flash drive prep.

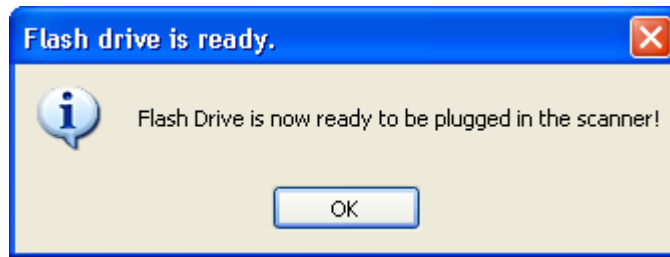

The **Up** arrow of the 1st line in the Scanner Configuration Preview Panel for the 7874 highlights.



9. Right-click the **Safely Remove Hardware** icon on the system tray to safely remove the flash drive. A Safe to Remove Hardware balloon message displays near the system tray.
10. Plug the flash drive in the scanner's USB peripheral port. The following lists the different actions the scanner initiates:

The scanner gives off a triple beep of ascending frequency, which indicates that the USB peripheral port recognized the flash drive and was able to enumerate. The triple beep sounds off regardless of the contents of the flash drive. If the scanner fails to give off the triple beep, this indicates a USB peripheral port failure or the USB peripheral port was not able to communicate with the flash drive.

The scanner speaks "Load program in 3 seconds...2...1...0...". The scanner resets after this message.

The scanner beeps and a triple beep of ascending frequency follows.

All five LEDs light up, then each one goes off from right to left. The scanner reboots after a successful firmware download.

The scanner beeps and a triple beep of ascending frequency follows.

The scanner gives off a low frequency triple beep, which indicates that the flash drive can be safely removed.

11. Unplug the flash drive from the scanner's USB peripheral port. The scanner then gives off a descending triple beep sound, which indicates a successful shutdown of the flash drive firmware.
12. Check the log file in the flash drive.
13. Check if the firmware extracted is present in the flash drive. The firmware binary file (with a filename specified on step 3) must be present in the flash drive's root directory.

### Firmware Download

This function downloads the scanner firmware from the flash drive to the scanner.

1. Select the Flash Drive Prep Tool icon. The following window displays.

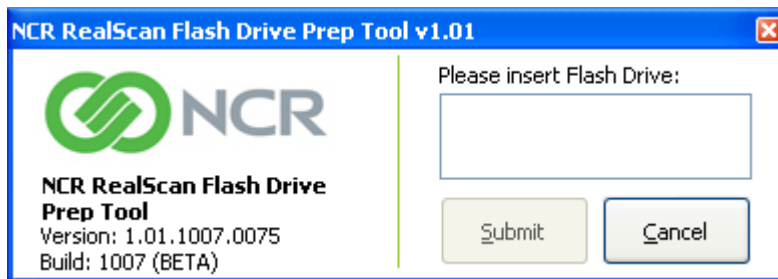

2. Insert the flash drive to be used. The application automatically detects the flash drive installed.
3. Select **Submit**. The following window displays.

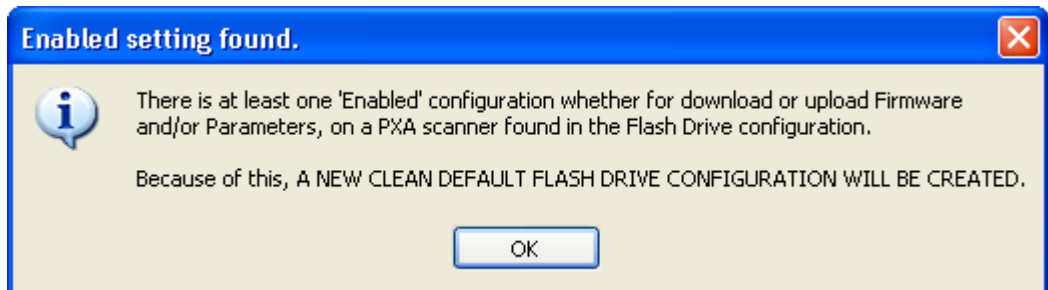

4. Select **OK**. The following window displays.



5. On the **Target Scanner** tab, select **7874**.
6. On the **FIRMWARE** groupbox, select the checkbox under **Update scanner with:**.
7. Select the Firmware from the dropdown menu.
8. Select the **Prep Flash Drive** button. The application then preps the flash drive. The following message box displays after a successful flash drive prep.

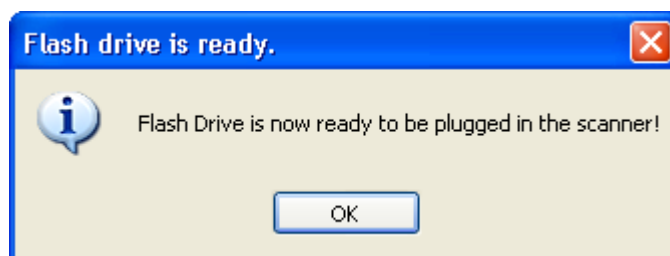

The **Down** arrow of the 1st line in the Scanner Configuration Preview Panel for the 7874 highlights.



9. Right-click the **Safely Remove Hardware** icon on the system tray to safely remove the flash drive. A Safe to Remove Hardware balloon message displays near the system tray.
10. Plug the flash drive in the scanner's USB peripheral port. The following lists the different actions the scanner initiates:
  - The scanner gives off a triple beep of ascending frequency, indicating that the USB peripheral port recognized the flash drive and was able to enumerate. The triple beep sound off regardless of the contents of the flash drive. If the scanner fails to give off the triple beep, this indicates a USB peripheral port failure or the USB peripheral port was not able to communicate with the flash drive.
  - The scanner speaks "Load program in 3 seconds...2...1...0...". The scanner resets after this message.
  - The scanner beeps and a triple beep of ascending frequency follows.
  - The LEDs blink from left to right while in flash mode. The scanner reboots after a successful firmware download.
  - The scanner beeps and a triple beep of ascending frequency follows.
  - The scanner gives off a low frequency triple beep, which indicates that the flash drive can be safely removed.
11. Unplug the flash drive from the scanner's USB peripheral port. The scanner then gives off a descending triple beep sound, which indicates a successful shutdown of the flash drive's firmware.

## Reset Tallies

This function clears the tallies performed and saved in the scanner.

1. Select the Flash Drive Prep Tool icon. The following window displays.

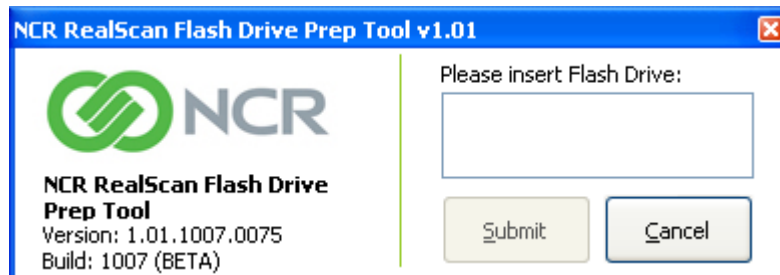

2. Insert the flash drive to be used. The application automatically detects the flash drive installed.
3. Select **Submit**. The following window displays.

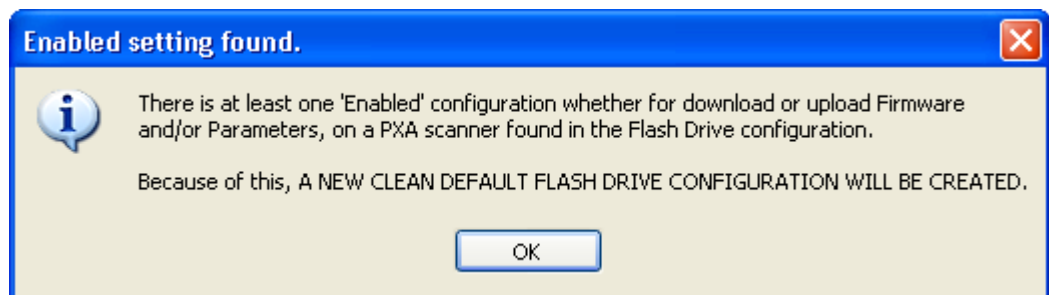

4. Select **OK**. The following window displays.

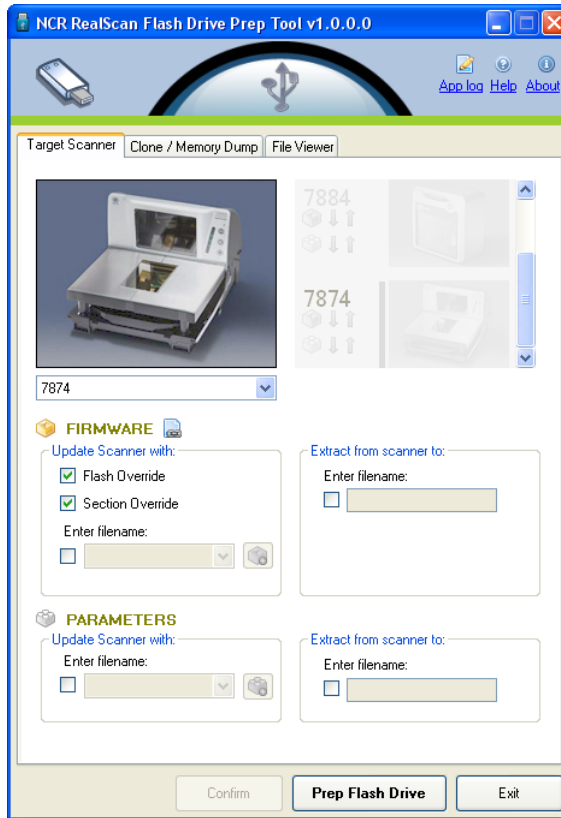

5. On the **Target Scanner** tab, select **7874** as the target scanner.
6. On the **Clone/Memory Dump** tab, select the **Memory Dump** checkbox. This enables the **Clear Tallies Afterward** checkbox under the Dumps groupbox.



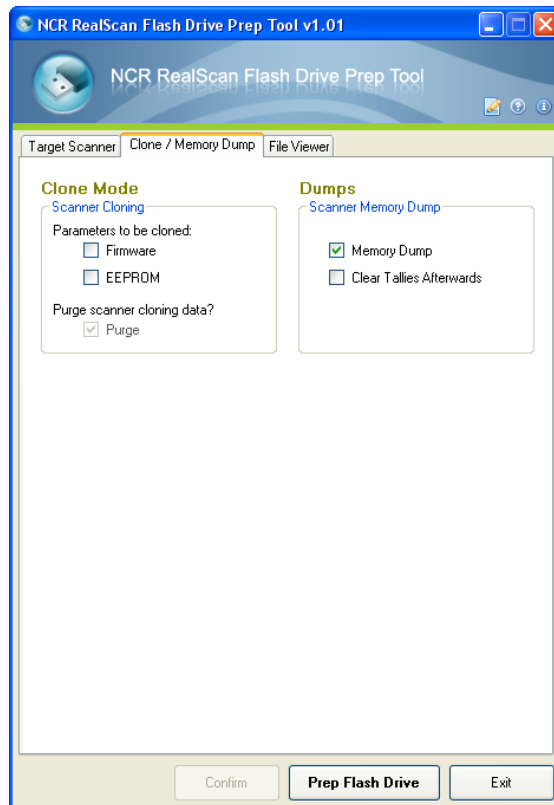

7. Select the **Clear Tallies Afterwards** checkbox.
8. Select the **Prep Flash Drive** button. The application then preps the flash drive. The following message box displays after a successful flash drive prep.

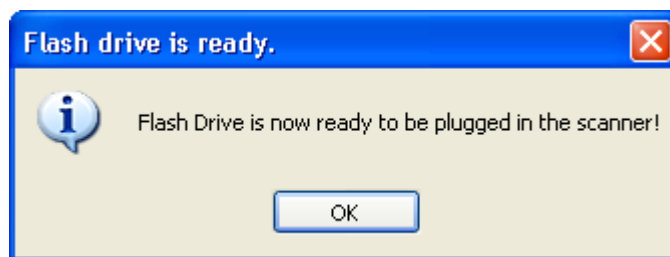

9. Right-click the **Safely Remove Hardware** icon on the system tray to safely remove the flash drive. A Safe to Remove Hardware balloon message displays near the system tray.
10. Plug the flash drive in the scanner's USB peripheral port.

The scanner gives off a triple beep of ascending frequency, which indicates that the USB peripheral port recognized the flash drive and was able to enumerate. The triple beep sounds off regardless of the contents of the flash drive. If the scanner fails to give off the triple beep, this indicates a USB peripheral port failure or the USB peripheral port was not able to communicate with the flash drive.

The scanner sounds off a low frequency triple beep, which indicates that the flash drive can be safely removed.

11. Unplug the Flash drive from the scanner's USB peripheral port. A descending triple beep sounds off, which indicates a successful shutdown of the flash drive's firmware.

### Scanner Cloning

Cloning uploads (from the scanner) a golden (fully configured for a customer site or enterprise) scanner's firmware file and/or configuration file and download the files or images into one or several target scanners. This is useful if all scanners must have the same firmware and configuration, if desired.

1. Identify the scanner to be labeled as the GOLD unit.

**Note:** The GOLD unit is the scanner to be cloned.

2. Select the Flash Drive Prep Tool icon. The following window displays.

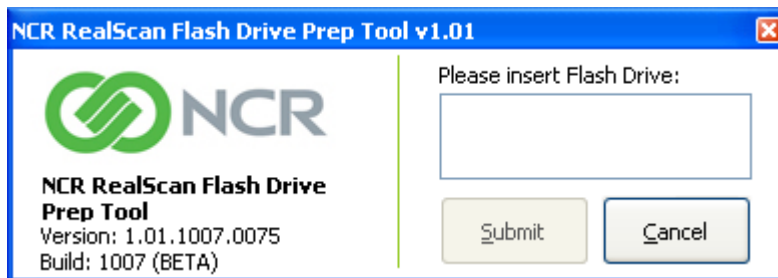

3. Insert the flash drive to be used. The application automatically detects the flash drive installed.
4. Select **Submit**. The following window displays.

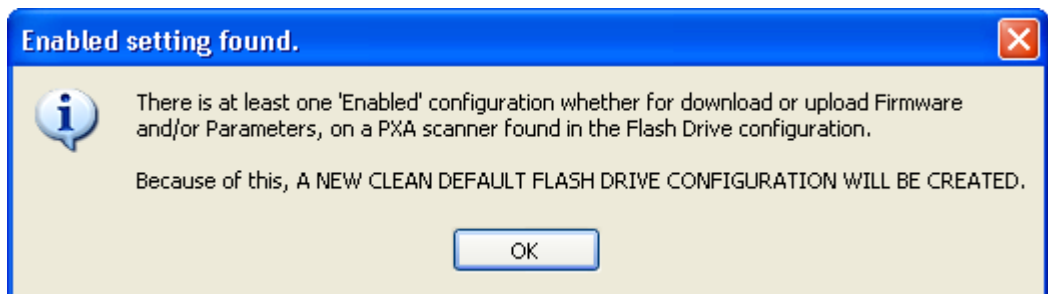

5. Select **OK**. The following window displays.

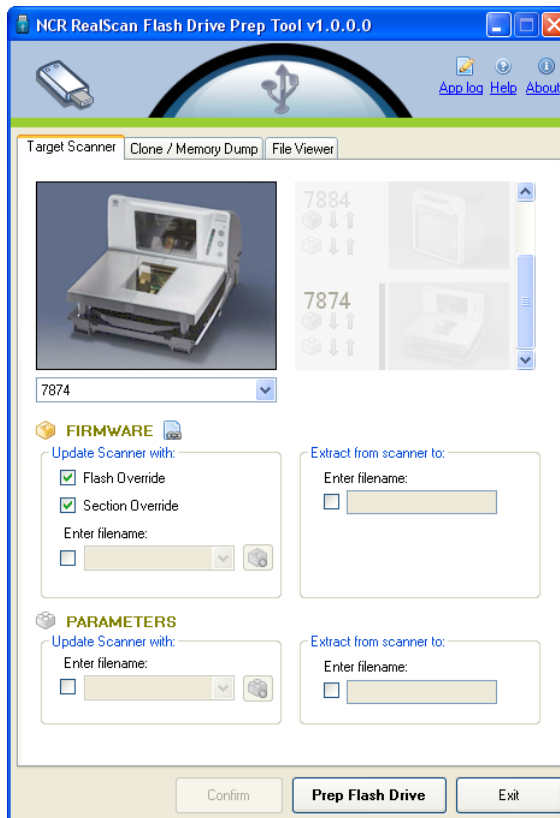

6. On the **Target Scanner** tab, select **7874** as the target scanner.
7. On the **Clone/Memory Dump** Tab, under the **Clone Mode** groupbox, select the parameters to be cloned.

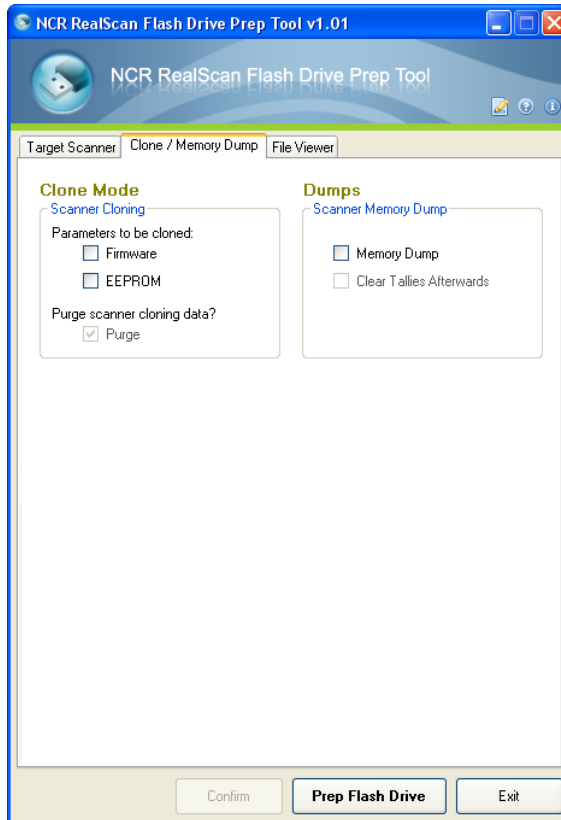

In this procedure, select either or both **Firmware** and **EEPROM** checkboxes, which means either or both Firmware and EEPROM of the GOLD unit, are cloned to the target scanner. The following is a sample window that displays after selecting **Firmware**.

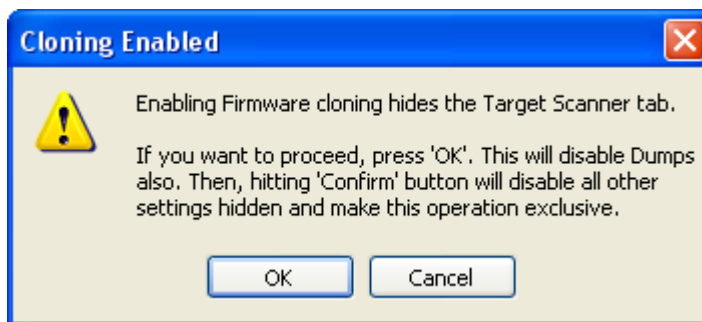

The following window displays after selecting **EEPROM**.

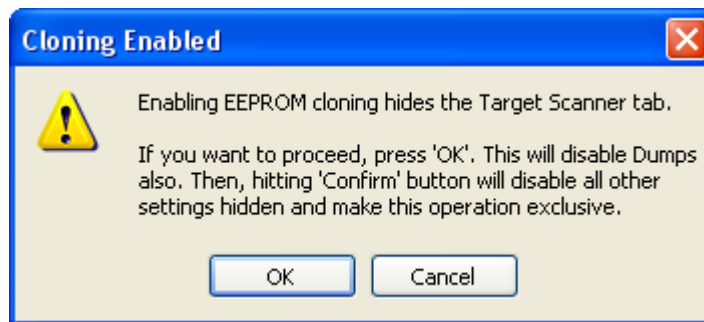

8. Select **OK**. The Confirm button is now enabled.
9. Select **Confirm**. The following window displays.



The following window displays if EEPROM was previously selected.

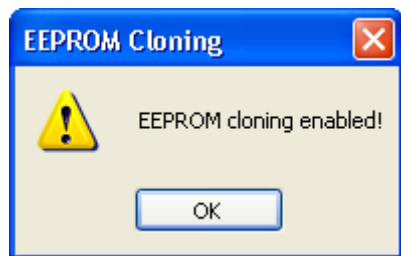

**Note:** All other settings; including settings in other tabs, are disabled after selecting **Confirm**.

10. Select the **Prep Flash Drive** button. The application then preps the flash drive plugged in. The following window displays after successfully prepping the flash drive.

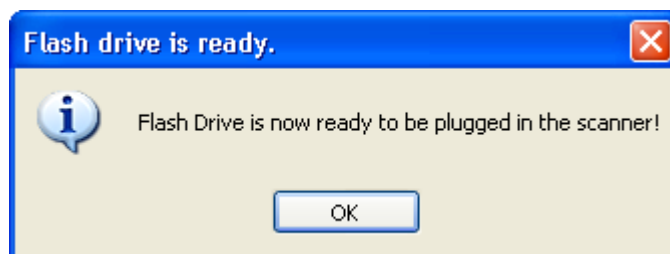

11. Right-click the **Safely Remove Hardware** icon on the system tray to safely remove the flash drive. A Safe to Remove Hardware balloon message displays near the system tray.

12. Plug the flash drive in the scanner's USB peripheral port.

The scanner gives off a triple beep of ascending frequency, which indicates that the USB peripheral port recognized the flash drive and was able to enumerate. The triple beep sounds off regardless of the contents of the flash drive. If the scanner fails to give off the triple beep, this indicates a USB peripheral port failure or the USB peripheral port was not able to communicate with the flash drive.

The scanner speaks "Load program in 3 seconds...2...1...0...". The scanner resets after this message.

The scanner beeps and a triple beep of ascending frequency follows.

All five LEDs light up, then each one goes off from right to left. The scanner reboots after a successful firmware and/or EEPROM upload depending on the parameters chosen by the user on Step 4.

The scanner beeps and a triple beep of ascending frequency follows.

The scanner sounds off a low frequency triple beep, which indicates that the flash drive can be safely removed.

13. Unplug the Flash drive from the scanner's USB peripheral port. A descending triple beep sounds off, which indicates a successful shutdown of the flash drive's firmware.

14. Plug the flash drive into the TARGET scanner's USB peripheral port.

The scanner gives off a triple beep of ascending frequency, which indicates that the USB peripheral port recognized the flash drive and was able to enumerate. The triple beep sounds off regardless of the contents of the flash drive. If the scanner fails to give off the triple beep, this indicates a USB peripheral port failure or the USB peripheral port was not able to communicate with the flash drive.

The scanner speaks "Load program in 3 seconds...2...1...0...". The scanner resets after this message.

The scanner beeps and a triple beep of ascending frequency follows.

The LEDs blink from left to right while in flash mode. The scanner reboots after a successful firmware and/or EEPROM download.

The scanner beeps and a triple beep of ascending frequency follows.

The scanner sounds off a low frequency triple beep, which indicates that the flash drive can be safely removed.

15. Unplug the Flash drive from the scanner's USB peripheral port. A descending triple sounds off, which indicates a successful shutdown of the flash drive's firmware.

At this point, other 7874 scanners may now be targeted for cloning using the flash drive.

### *Scanner Cloning Using Programming Tags*

The scanner has some programming sequences that let you clone a unit if you did not get a chance to run the Flash Drive Prep Tool before going to the site. This requires programming tags. Follow these steps to perform scanner cloning with programming tags:

1. Bring a flash drive before going to the site to work on the scanner.
2. Select a scanner from the site—the one you want to clone.
3. Plug the flash drive into the scanner's USB peripheral port.
4. Use any one of these three sequences to set up the flash drive:
  - PROGRAM MODE→HEX 7→HEX F→HEX C→SAVE & RESET  
This sequence clones the firmware and parameters.
  - PROGRAM MODE→HEX 7→HEX F→HEX D→SAVE & RESET  
This sequence clones Firmware only.
  - PROGRAM MODE→HEX 7→HEX F→HEX E→SAVE & RESET  
This sequence clones Parameters only.

The scanner then resets. Let the scanner copy the requested clone data onto the flash drive. If the firmware is successfully cloned, the scanner speaks "Load program in 3 seconds ...2...1...0".

5. Select the target scanner.

### File Viewer

Every time an operation is performed (Firmware upload, Parameter download, Memory dump, and so forth), the application creates a log (.log) and dump (.dmp) file. This option permits the user to view and delete these files.

1. Select the Flash Drive Prep Tool icon. The following window displays.

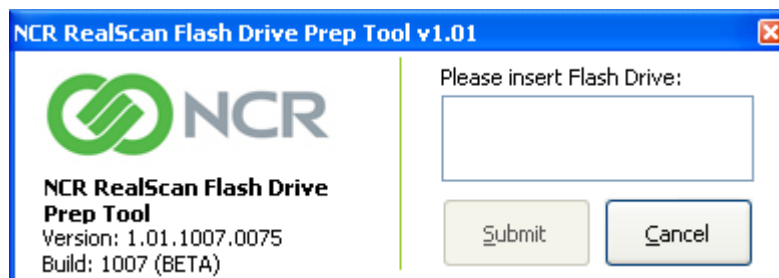

2. Insert the flash drive to be used. The application automatically detects the flash drive installed.
3. Select **Submit**. The following window displays.

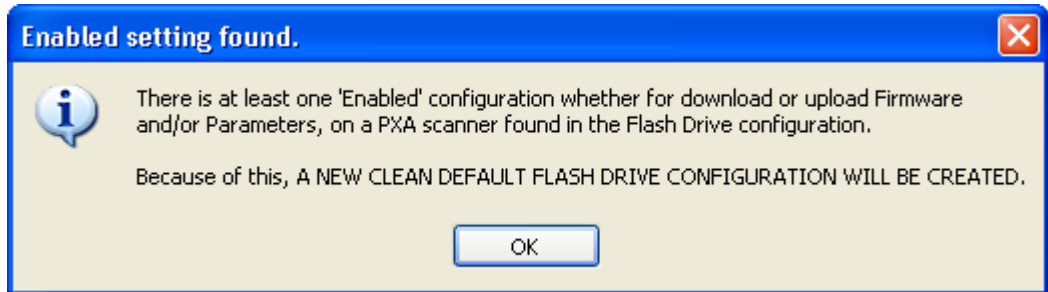

4. Select **OK**. The following window displays.

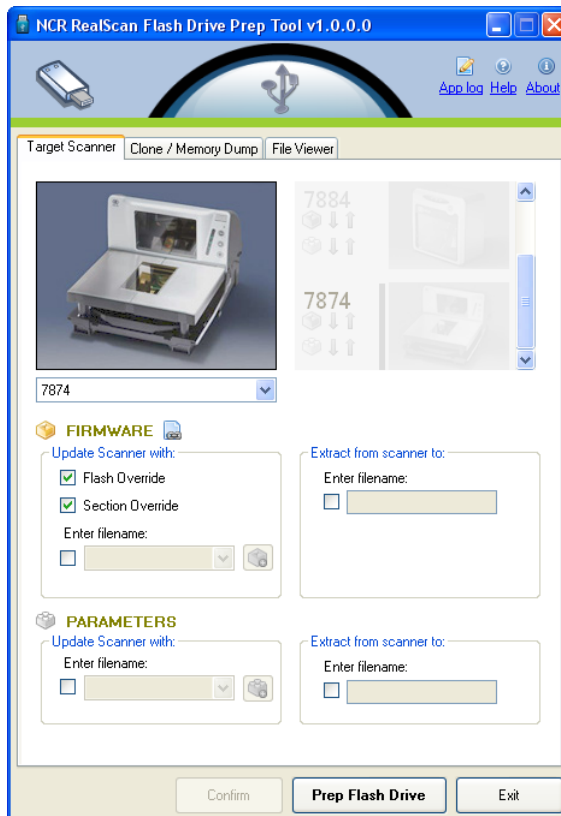

5. On the **Target Scanner** tab, select **7874** as the target scanner.



6. Select the **File Viewer** tab. The following window displays.

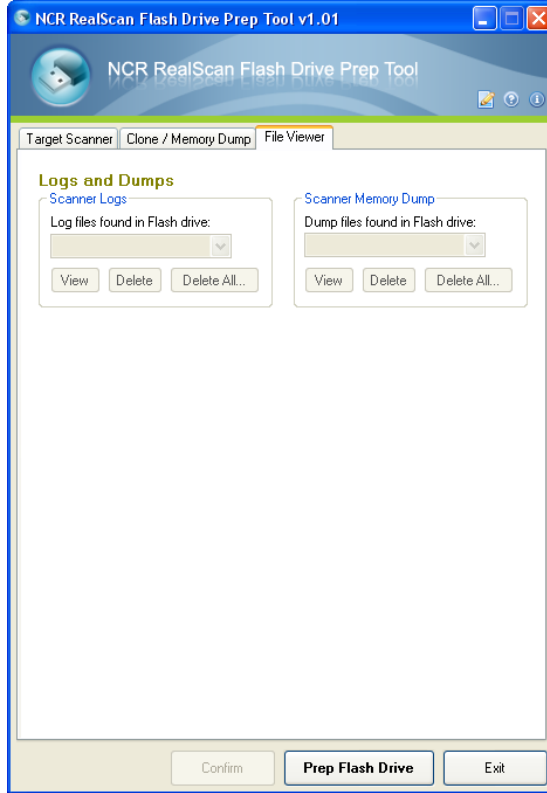

7. Select which file to work with using the dropdown menu in either **Scanner Logs** or **Scanner Memory Dump**.
8. Select **View** to view the file (Wordpad format), **Delete** to delete the file, or **Delete All** to delete all .log or .dmp files available. The following is a sample selection of the log file.

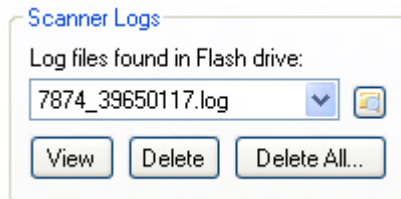

The following is a sample selection of the dump file.

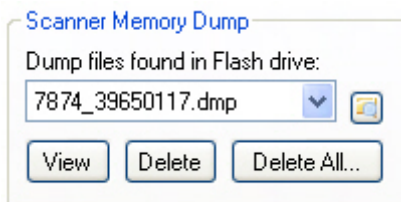

After selecting **Delete**, the following window displays.

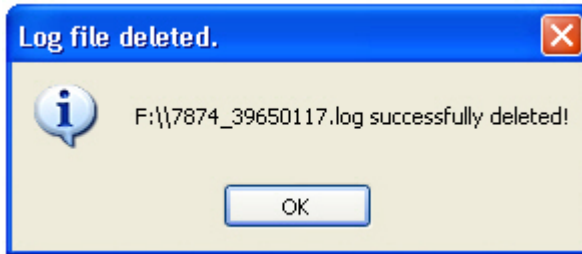

**Note:** This is a sample window if the Scanner Logs **Delete** button is selected.

If **Delete All** is selected, the following window displays.



**Note:** This is a sample window if the Scanner Memory Dump **Delete All** button is selected.

## *Chapter 6:* Troubleshooting

---

This chapter contains troubleshooting charts that are designed for locating and correcting certain problems without the aid of a trained technician. If the problem cannot be corrected using these charts, a trained technician can use Scan Doctor to help identify a faulty component.

## 7874 Diagnostics and Troubleshooting

There are two kinds of diagnostics that run on each scanner unit. The Level 0 Diagnostics run every time the scanner unit is powered up. This determines if the unit is operational. The Operational Diagnostics continuously check laser diode, spinner motor, communications, and bar code reading.

### Scale Diagnostics

Scale Level 0 Diagnostics are performed on power-up to ensure the scale is operating normally. An error code is displayed on the RealScan 25 Remote Display or Light Bar identifies the problem.

The following table lists the error codes and problems that may be detected by the Level 0 or operational diagnostics:

**Note:** The scale error code is also displayed on the Remote Scale Display, if one is present.

## Scale Troubleshooting Codes

**Note:** LED 1 is the first LED from the bottom of the Scan Adviser.

Error Code	Possible Cause	Corrective Action	Scan Adviser Patterns
1--- 2--- 3---	Out of range calibration error	<ol style="list-style-type: none"> <li>1. Calibrate scale.</li> <li>2. If error code persists, check: Scale cables and Power Supply Digital Board Scale Assembly</li> </ol>	Code 1: LED 1 = blue LED 2 = orange LED 3 = orange  Code 2: LED 1 = blue LED 2 = orange LED 3 = orange LED 4 = orange  Code 3: LED 1 = blue LED 2 = orange LED 3 = orange LED 4 = orange LED 5 = orange
4---	Calibration Switch is pressed for more than 3 seconds	<ol style="list-style-type: none"> <li>1. Check for objects that interfere with the Calibration Switch.</li> <li>2. Calibrate scale.</li> <li>3. If error code persists, have scanner repaired.</li> </ol>	LED 1 = blue LED 2 = red
4---	Possible scale error Internal scale connection problem or unit does not have scale	<ol style="list-style-type: none"> <li>1. Press <b>Scale Zero</b> button and retry.</li> <li>2. Verify unit is a scanner/scale.</li> <li>3. If unit does not have a scale, program for scanner only (<b>Program Mode, Hex 3, Hex 0, Hex 4, &amp; Save and Reset</b>)</li> <li>4. If error code persists, have scanner repaired.</li> </ol>	LED 1 = blue LED 2 = red
5---	Scale drift	<ol style="list-style-type: none"> <li>1. Verify that nothing is on the Top Plate.</li> <li>2. Lift the Top Plate and verify that there are no objects under it.</li> <li>3. Verify that nothing interferes with the Produce Guard.</li> <li>4. Press the <b>Scale Zero</b> button.</li> <li>5. If error code persists, have scanner repaired.</li> </ol>	LED 1 = blue LED 2 = red LED 3 = red
6---	Failure to update program parameters in EEPROM	<ol style="list-style-type: none"> <li>1. Reset scanner.</li> <li>2. Calibrate scale.</li> <li>3. If error code persists, have scanner repaired.</li> </ol>	LED 1 = blue LED 2 = red LED 3 = red LED 4 = red
7---	Error reading program parameters from EEPROM	<ol style="list-style-type: none"> <li>1. Calibrate scale.</li> <li>2. If error code persists, have scanner repaired.</li> </ol>	LED 1 = blue LED 2 = red LED 3 = red LED 4 = red LED 5 = red
8---	Scale not exercised properly	<ol style="list-style-type: none"> <li>1. Press on the scale during calibration process.</li> <li>2. Keep pressing on the scale until all red LEDs turn to blue.</li> <li>3. Repeat procedure.</li> </ol>	LED 1 = blue LED 2 = green
9---	Linearity problem	<ol style="list-style-type: none"> <li>1. Calibrate scale.</li> <li>2. If error code persists, have scanner repaired.</li> </ol>	LED 1 = blue LED 2 = green LED 3 = green
Scale display is blank	Top Plate or Produce Guard has possible obstruction	<ol style="list-style-type: none"> <li>1. Press <b>Scale Zero</b> button.</li> <li>2. Remove interference around edge of Top Plate or Produce Guard and Front Bezel.</li> <li>3. Remove any foreign objects from under the Top Plate.</li> </ol>	

## Scanner Diagnostic Codes

Level 0 diagnostics are run every time the 7874 is powered up. This diagnostic determines if the unit is operational. Level 0 diagnostics are also run when the unit is in Base Programming Mode and when the **Default, Save and Reset**, or **Abort** tag is read. Refer to chapter 5 for more information.

The following table lists the scanner error codes and problems that may be found by the Level 0 or operational diagnostics:

**Note:** LED 1 is the first LED from the bottom of the Scan Adviser.

Error Codes	Problem	Suspect Component/s	Scan Adviser Patterns
	No LED light	Power Supply Power/communication cable disconnected or POS terminal turned off. Optics Engine/Digital Board Assembly Tower Board Assembly	None
2	RAM - Write/Read failure	Optics Engine/ Digital Board Assembly	LED 1 = red LED 2 = orange LED 3 = orange LED 4 = orange
5	Motor - Not running at proper speed	Optics Engine/ Digital Board Assembly	LED 1 = red LED 2 = blue LED 3 = blue
6	EEPROM - Cannot load contents into memory	Optics Engine/ Digital Board Assembly	LED 1 = red LED 2 = blue LED 3 = blue LED 4 = blue
9	IBM mode - scanner does not detect POS terminal TRMPWR voltage, scanner may still scan or weigh	Cable not connected from Scanner to POS POS not turned on IBM Port problem	LED 1 = red LED 2 = green LED 3 = green
11	Laser - Not turned on	Optics Engine/ Digital Board Assembly	LED 1 = red LED 2 = green LED 3 = green LED 4 = green LED 5 = green
12	ROM - Sum check failure	Optics Engine/ Digital Board Assembly	LED 1 = red LED 2 = red
13	FPGA Failure (missing/failed part)	Optics Engine/ Digital Board Assembly	LED 1 = red LED 2 = red LED 3 = red

## Isolating Sensormatic® Problems

<b>Problem</b>	<b>Possible Cause</b>	<b>Corrective Action</b>
Does not deactivate tags	Sensormatic® ScanMax™ Pro Controller not turned on	Check the On/Off switch on the ScanMax™ Pro Controller if it is turned on.
Does not deactivate tags	Faulty Sensormatic® Interlock Cable	Replace Sensormatic® Interlock Cable.
Does not deactivate tags	Faulty Sensormatic® ScanMax™ Antenna or Antenna Cable	Replace Sensormatic® ScanMax™ Antenna or Antenna Cable.
Does not deactivate tags	Faulty Controller	Replace Sensormatic® ScanMax™ Pro Controller.
Red Status Indicator flashes rapidly	Sensormatic® ScanMax™ Pro Controller not turned on	Check the On/Off switch on the ScanMax™ Pro Controller if it is turned on.





# Appendix A: NCR Scanner Programming Tags

---

## Scanner Programming Tags

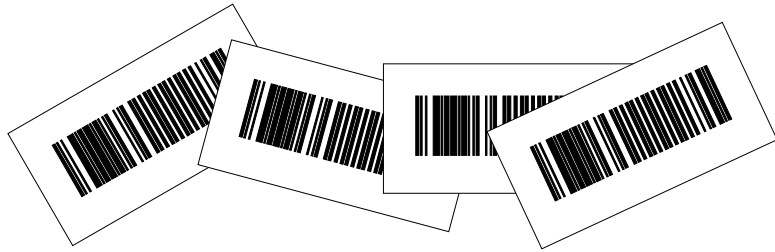

BST0-2121-74    Release O

27064

Volume Adjustment



11817

Reset



11818

Default



R0046

Programming Mode



R0042

End

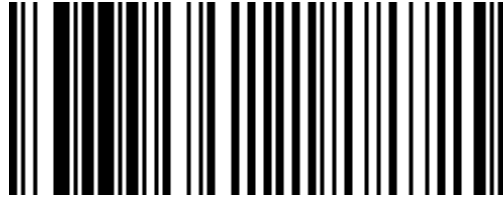

R0043

Save and Reset

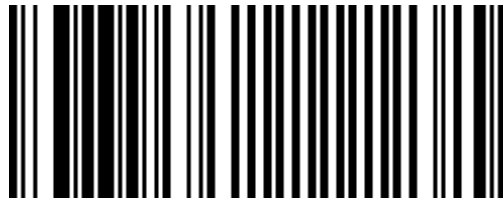

R0044

Abort

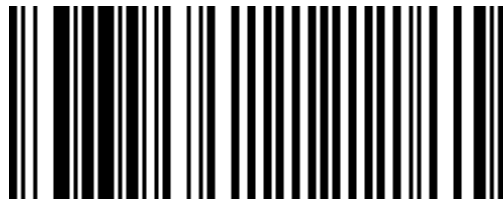

R0045

Diagnostic Mode

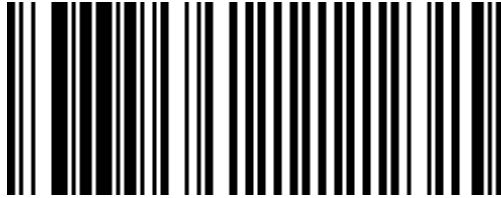

R0041

Speak Scanner Serial Number

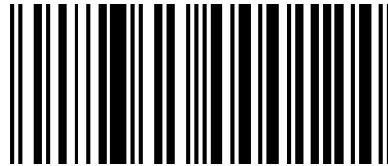

Available with firmware version 497-0433606 or later.

22786

Speak Barcodes Currently Enabled



Available with firmware version 497-0433606 or later.

22785

Mode 1



Slot Scanner (PACESETTER Plus)

11500

Mode 2



Slot Scanner (PACESETTER Plus)

11501

Reset Tallies



Slot Scanner (PACESETTER Plus)

11502

Firmware Flashing



Super ASIC and PXA Models

27581

Hex 0

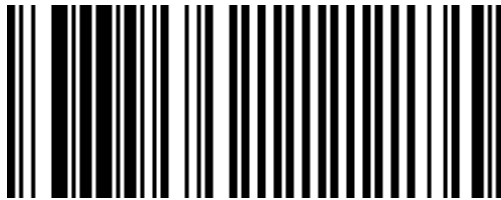

R0048

Hex 1



R0049

Hex 2

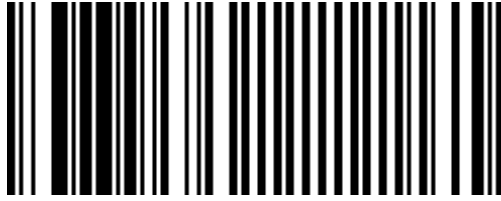

R0050

Hex 3

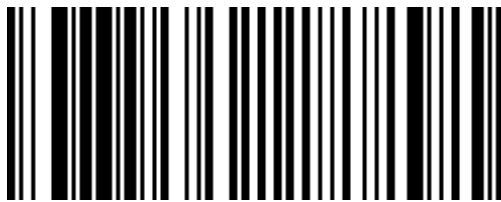

R0051

Hex 4

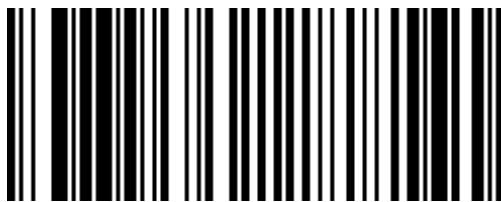

R0052

Hex 5

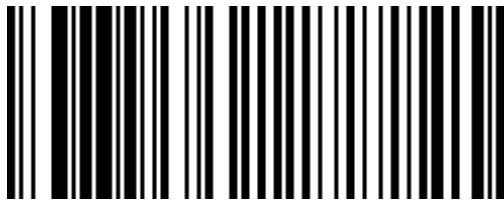

R0053

Hex 6



R0054

Hex 7



R0055



Hex 8

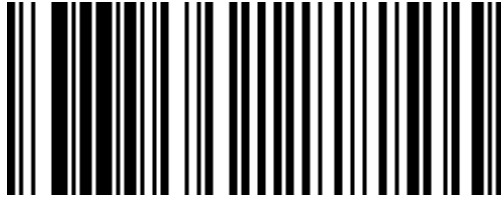

R0056

Hex 9

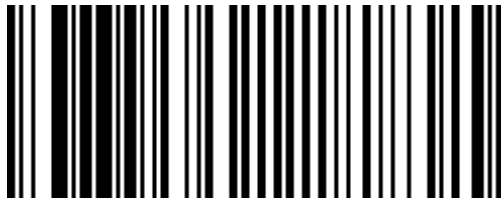

R0057

Hex A



R0058

Hex B

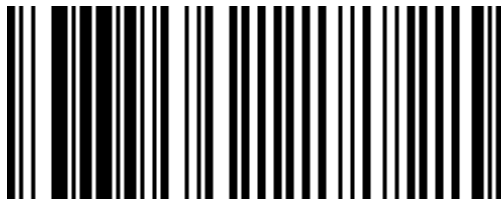

R0059

Hex C



R0060

Hex D



R0061

Hex E

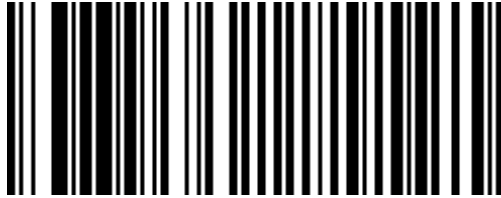

R0062

Hex F



R0063

ASCII Code Chart															
00	NULL	10	DLE	20	SP	30	0	40	@	50	P	60		70	p
01	SOH	11	DC1	21	!	31	1	41	A	51	Q	61	a	71	q
02	STX	12	DC2	22	"	32	2	42	B	52	R	62	b	72	r
03	ETX	13	DC3	23	#	33	3	43	C	53	S	63	c	73	s
04	EOT	14	DC4	24	\$	34	4	44	D	54	T	64	d	74	t
05	ENQ	15	NAK	25	%	35	5	45	E	55	U	65	e	75	u
06	ACK	16	SYN	26	&	36	6	46	F	56	V	66	f	76	v
07	BEL	17	ETB	27	'	37	7	47	G	57	W	67	g	77	w
08	BS	18	CAN	28	(	38	8	48	H	58	X	68	h	78	x
09	HT	19	EM	29	)	39	9	49	I	59	Y	69	i	79	y
0A	LF	1A	SUB	2A	*	3A	:	4A	J	5A	Z	6A	j	7A	z
0B	VT	1B	ESC	2B	+	3B	;	4B	K	5B	[	6B	k	7B	{
0C	FF	1C	FS	2C	,	3C	<	4C	L	5C	\	6C	l	7C	
0D	CR	1D	GS	2D	-	3D	=	4D	M	5D	]	6D	m	7D	}
0E	S0	1E	RS	2E	.	3E	>	4E	N	5E	^	6E	n	7E	~
0F	S1	1F	US	2F	/	3F	?	4F	O	5F	_	6F	o	7F	DEL

R0040



## Appendix B: Additional Diagnostic Functions

---

### Scale

**Note:** The following diagnostic functions are available only for SuperASIC firmware dated AFTER January 2007.

#### DM-4-3 Speak Weight

To enable the scanner to speak the weight shown in the display, scan the **Diagnostic Mode, Hex 4, and Hex 3** programming tags. If it is not valid or there is no scale, the scanner will speak "Not Scale".

#### DM-4-B Speak and Display Calibration Date

Scan the **Diagnostic Mode, Hex 4, and Hex B** programming tags to take the calibration date (which must have been previously set by a command) and enable the scanner to speak and display the date in

'C MM.DD.YY' format.

### Scanner Service Diagnostics

Service Diagnostics provide tests that are not available in the Power-On Wellness Check or On-Going Wellness Check diagnostics. To access Service Diagnostics, scan the **Diagnostic Mode** tag as the first tag after applying power to the 7874. This causes the 7874 to enter the Base Diagnostic State where specific diagnostic tests are available. Scan the appropriate Hex tags to select a diagnostic test. To end Service Diagnostics, remove power from the 7874.

The following table identifies the Service Diagnostic tests.

Base Diagnostic State	Hex 3	Communication Protocol
	Hex 4 Hex A	Display Firmware Version
	Hex 2	RS-232 Turnaround
	Hex 1	Toad Test
	Hex 4 Hex 1	Vibration Check

### Communication Protocol

Perform the following procedure to determine the communications protocol programmed in your 7874.

1. Scan the **Diagnostic Mode** tag to enter Base Diagnostic state— this must be the first tag scanned after applying power to the 7874.
2. Scan the **Hex 3** tag. The Good Read tone for this tag sounds (three beeps). If the 7874 has the Voice feature enabled, the scanner will speak its communications protocol type.
  - RS232
  - RS232 USB
  - IBM 4A
  - IBM 4A USB

### Display Firmware Version

This routine displays the version level of the firmware on the 7874 Digital Board. There are no pass/fail points for this routine; it can only be used to read information. Perform the following procedure.

1. Scan the **Diagnostic Mode** tag to enter the Base Diagnostic state—this must be the first tag scanned after applying power to the 7874.
2. Scan the **Hex 4** tag, then the **Hex A** tag to read the firmware version level.
3. At this point, the scanner will begin speaking the firmware version. The Scanner will speak “Version Two Scanner 4 9 7 x x x x x x”, where the ‘x x x x x x’ refers to the firmware release number.
4. After taking a note of the firmware version, the scanner must power cycle (power off, then power on) to put it back into operational state. The Reset Tag can be used.

### RS232 Turnaround

The RS232 Turnaround test checks the RS232 interface in the 7874. An RS232 turnaround plug is needed to run this test.

1. Remove power from the 7874.
2. Install the RS232 turnaround plug (497–0300793).
  - Lift the 7874 out of the checkstand and disconnect the Interface cable.
  - Install turnaround plug into the connector where you removed the interface cable.
3. Supply power to the 7874.

4. Scan the **Diagnostic Mode** tag to enter the Base Diagnostic state – must be the first tag scanned after applying power to the 7874.
5. Scan the **Hex 2** tag to start the RS232 Turnaround test.
  - Test Passes – a Good Read tone is emitted, the scanner will speak “RS232 Passed”, and “232 232” will appear on the remote display
  - Test Fails – the scanner will speak “RS232 Failed”
6. Repeat steps 4 and 5 to repeat the test.
7. Remove power from the 7874.
8. Disconnect the turnaround plug.
  - Connect interface cable to connector where you removed the turnaround plug.
  - Set the 7874 into the hole in the checkstand and install the Top Plate.
9. Supply power the 7874.

*Possible Bad Component*

- Optics Engine \ Digital Board Assembly

**Toad Test**

The Toad test checks the scanner's ability to read UPC bar codes in various parts of the scan pattern. The test repeats until ended by removing power from the 7874.

1. Scan the **Diagnostic Mode** tag to enter the Base Diagnostic state—must be the first tag scanned after applying power to the 7874.
2. Scan the **Hex 1** tag to enter the Toad test mode.
3. Position a good UPC or EAN tag within the scan pattern.
  - a. The green status Indicator displays and the Good Read tone sounds if the scanner can read the bar code.
  - b. The red status Indicator displays if the scanner cannot read the bar code.
4. Repeat Step 3 for various areas of the scan pattern.
5. Remove power from the 7874 to end this test.

*Possible Bad Components*

- Optics Engine \ Digital Board Assembly

## Vibration Check

The Vibration Check tests the level of vibration or movement in the checkstand and scanner/scale. There is no pass/fail point for this test; it can only be used as a diagnostic tool. Perform the following procedure.

1. Remove power from the 7874.
2. If the 7874 does not have a RealScan 25 Remote Customer Display, remove the Tower Cabinet and connect the Field Service Calibration Display to the display connector on the Digital Board.
3. Apply power to the 7874.
4. Scan the **Diagnostic Mode** tag to enter the Base Diagnostic state—must be first tag scanned after applying power to the 7874.
5. Scan the **Hex 4** tag, then the **Hex 1** tag to enter the Vibration Check test.
6. Place a small weight on the scale (for example, a medium size coin).
7. Watch the display for 10 to 15 seconds and note the range of readings.
8. If the readings vary more than  $\pm 0.001$  kg ( $\pm 0.004$  lb), there may be a problem.
9. If possible, move the 7874 to a known stable location (like the floor) and take measurements again.
  - a. If the readings vary less than they did in the checkstand, the vibration is probably in the checkstand. This could be the result of belt motors, ventilation fans, and so forth.
  - b. If the readings are about the same, the problem could be in the 7874. If you need assistance resolving this problem, contact the Retail Global Support Center.
10. After using this diagnostic check, remove power from the 7874 to end the test.
11. If a Field Service Calibration Display is used, disconnect it and install the Tower Cabinet.



## Appendix C: Obtaining Information Products

---

Additional information about the NCR 7874 can be obtained by contacting an NCR representative. Information Products are available through several different channels. An order form is needed if using fax, e-mail, or mail order. Order forms are available to NCR personnel through QuickLook. In QuickLook, click on QuickLook Services, Forms and Templates, and then select Information Products Order Form.

### Web Site

<http://www.info.ncr.com> (Anyone)

### Online Order

Connect System (NCR only)

### Phone Order

800-543-2010 (select option #2)

### Fax Order

770-831-2821

### Email

[ERI210013@exchange.DaytonOH.NCR.COM](mailto:ERI210013@exchange.DaytonOH.NCR.COM)

### Mail Order

NCR Corporation—Sales Service Center  
3200 Shawnee Industrial Way  
Suwanee, Georgia 30024



## *Appendix D:* **Technical Support**

---

Sometimes situations arise that require more information than what is provided in this NCR NCR RealPOS Low Profile Bi-Optic Scanner/Scale (7874) User Guide. Technical support is available as follows:

- In the United States : 1-800-262-7782
- In other countries : call the local NCR office
- To order parts : 1-800-438-7830



# Appendix E: User Feedback

---

**Please print this page, answer the questions, and fax it to us at 770-813-3963.**

**Information Product :** NCR RealPOS Low Profile Bi-Optic Scanner/Scale (7874)  
User Guide

**Order Number :** B005-0000-1724

**Issue Level :** A

**Please enter your rating by circling the appropriate number.**

How do you rate the technical accuracy of this document?

Poor      1      2      3      4      5      Excellent

How you rate the organization of this document?

Poor      1      2      3      4      5      Excellent

How easy is it for you to locate specific information in this document?

Very Difficult      1      2      3      4      5      Excellent

How well did this document help you perform your job?

Not Well      1      2      3      4      5      Excellent

How do you rate this document overall?

Poor      1      2      3      4      5      Excellent

**Please enter any additional comments.**

---

---

---

---

---

---

**Please enter the following so we can contact you concerning your comments.**

Name : \_\_\_\_\_

Address : \_\_\_\_\_

\_\_\_\_\_

Phone : \_\_\_\_\_ Fax : \_\_\_\_\_

Email : \_\_\_\_\_